



ÜRÜN KATALOĐU
PRODUCT CATALOG
2019

Kurulduğumuz ilk günden bu yana, ülkemize ve insanımıza duyduğumuz güven, çalışma azmimizden hiçbir şey kaybetmeden daima yeniyi, daha iyiyi hedefleyerek ve günümüz teknolojisini yakından takip ederek 1983 yılından bu yana hep yanınızda olduk.

Since 1983, the first day we were founded, we have always been on your side by aiming for better and new without losing anything from our commitment to work with confidence that we have to our country and our people.





İÇİNDEKİLER INDEX



06

ANAHTAR GRUBU
SWITCH GROUP

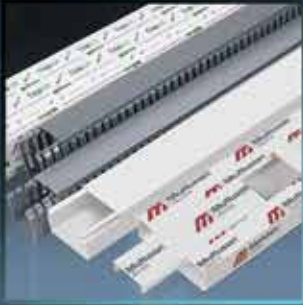

62

KABLO KANALLARI
CABLE TRUNKING



121

SANAYİ ÜRÜN GRUBU
INDUSTRIAL PRODUCT GROUP



157

TESİSAT MALZEMELERİ
INSTALLATION MATERIALS



205

AYDINLATMA GRUBU
LIGHTING GROUP

RITA SERİSİ
ELITRA PLUS SERİSİ
CANDELA SERİSİ
CANDELA KIDS
DARIA SERİSİ
NEMLİYER (SIVA ÜSTÜ)
BRON (SIVA ÜSTÜ)
GRUP PRİZLER
AKSESUARLAR

RITA SERIES
ELITRA PLUS SERIES
CANDELA SERIES
CANDELA KIDS
DARIA SERIES
NEMLİYER (SURFACE)
BRON (SURFACE)
GROUP SOCKETS
ACCESSORIES

HALOGEN FREE KABLO KANALI
KENDİNDEN KAPAKLI KANALLAR
DIŞTAN KAPAKLI KANALLAR
MEKS 100'LÜK SERİ PRİZ MONTAJ SETLERİ
MEKSPLUS SERİSİ İÇTEN KAPAKLI KANALLAR
SÜPÜRGEK KABLO KANALLARI
ZEMİN KABLO KANALLARI
PROFİLLER
KLİMA KANALI
SİDEM SERİSİ KABLO KANALLAR
HALOGEN FREE DELİKLİ KABLO KANALI
DELİKLİ KABLO KANALI

HALOGEN FREE CABLE TRUNKING
CABLE TRUNKING WITH INTRINSIC COVER
CABLE TRUNKING WITH EXTERNAL COVER
MEKS 100 SERIES PLUG SOCKET ASSEMBLY SETS
MEKSPLUS SERIES INTERNAL COVER CABLE TRUNKING
SKIRTING BOARD CABLE TRUNKING
FLOOR CABLE TRUNKING
PROFILES
AIR CONDITIONING TRUNKING
SIDEM SERIES CABLE TRUNKING
HALOGEN FREE PERFORATED CABLE TRUNKING
PERFORATED CABLE TRUNKING

SANAYİ FİŞ - PRİZ GRUBU
SİNYAL VE KUMANDA BUTONLARI
ETANJ BUTON KUTULARI
VİNÇ KUMANDA BUTONLARI
SÜPER ETANJ RAKORLAR
RAY KLEMENSLER
SIKMALI TİP KABLO PAPUÇLARI
SIRA KLEMENSLER
RAYLAR, TOPRAKLAMA ÇUBUĞU VE BARALAR
DÖNER LAMBA, FLAŞÖRLÜ LAMBA VE SİRENLER
İKAZ LAMBALARI
TERMOPLASTİK BUATLAR

PLUG - SOCKET GROUP
SIGNAL AND CONTROL BUTTONS
WATERPROOF BUTTON BOXES
CRANE CONTROL BUTTONS
SUPER WATERPROOF CABLE GLANDS
RAIL TERMINAL BLOCKS
CLAMPING TYPE CABLE TERMINAL LUGS
CONNECTOR (TERMINAL BLOCKS)
RAILS, GROUNDING ROD AND BUSBARS
ROTATING BEACON, BLINKER BEACON AND SIRENS
WARNING LIGHTS
THERMOPLASTIC JUNCTION BOXES

COMFORT SİGORTA VE ZAYIF AKIM KUTULARI
W OTOMAT KUTULARI
TELEFON DAĞITIM KUTULARI VE AKSESUARLARI
MODÜL BAĞLANTI ÇATISI
ÇELİK SPİRALLER PVC SPİRAL VE BORULAR
HALOGEN FREE SPİRALLER
SİBOR SERİSİ BORULAR
SUSTALAR VE BUAT KAPAKLARI
BETON DUVAR KASALARI
PLASTİK KASA VE BUATLAR
KROŞELER
PLASTİK DÜBELLER

COMFORT FUSE AND LOW-CURRENT BOXES
FUSE BOXES
TELEPHONE DISTRIBUTION BOXES (HUBS) and ACCESSORIES
MODULE CONNECTION RACK
STEEL SPIRALS PVC SPIRALS AND PIPES
HALOGEN-FREE SPIRALS
SIBOR SERIES PIPES
CABLE PULLERS AND JUNCTION BOX COVERS
CONCRETE WALL CASINGS
PLASTIC CASINGS AND JUNCTION BOXES
CABLE STRAPS
PLASTIC DOWELS

LED AYDINLATMA ARMATÜRLERİ
PARABOLİK TAVAN ARMATÜRLERİ
YÜKSEK TAVAN AYDINLATMA ARMATÜRLERİ
BANT TİPİ ARMATÜRLER
TAVAN ARMATÜRLERİ
ACİL DURUM ARMATÜRLERİ

LED LIGHTING LUMINARIES
PARABOLIC CEILING LIGHTING FIXTURES
HIGH CEILING LIGHTING LUMINAIRE
BATTEN TYPE LUMINAIRE
CEILING LIGHTING FIXTURE
EMERGENCY LIGHTING



Mustafa KAÇMAZ
Yönetim Kurulu Başkanı
Chairman of the
Executive Board / CEO

Değerli Dostlarımız,

Endüstriyel hikâyemiz, 1983 yılında Karaköy Mağazamızda, Sektöre ve Ülkemize duyduğumuz güvenle başladı. Dönemin zor koşullarına rağmen, Mutlusan'ın geleceğine inandık. Koşullar nedeniyle kısıtlı miktarda başlattığımız üretim ve bunu takip eden uzun dönemdeki sabırlı çalışmalarımız ile günümüzde ortaya çıkan büyük Mutlusan ailemizin tohumlarını attık.

Mutlusan Ailesi olarak, zorlukları aşmak, yenilikçilik, dürüst ve işinin ehli üreticilik, tüketiciye ve müşterilerimize saygı, yatırım tutkusu gibi konularda ilk günkü heyecanla bugün de devam ediyoruz.

Son yıllarda hızlı bir değişim ve büyüme süreci yaşıyoruz. Yeni yatırımlar, teknolojik yenilenme, kurumsallaşma çalışmaları, yeniden yapılanma, yeni pazarlar ve yeni ürünlerle gelişimimizi sürekli hale getirmeye çalışıyoruz. Şirketimizde durmaksızın büyüme imkânları araştırılarak, verimliliğin artırılmasına yönelik planlamalar yapılıyor. Yenilikçilik desteklenerek, teknolojik altyapı güçlendiriliyor ve insan kaynaklarımızı zenginleştiriyoruz.

Geleneksel değerlerimizi koruyarak değişen dünyaya ayak uydurma başarısını sürekli kılmayı hedefliyoruz.

Küreselleşme sayesinde şirketler, ülkelerinden kilometrelerce uzaktaki tüketicilere yanı başlarındaymış gibi ulaşabiliyorlar.

Ürünlerimizle milyonlarca kilometre ötedeki insanlara ulaşarak, onların yaşamlarına değer katmak için çalışıyoruz. Bu bize, Türkiye markası olarak sadece ülkemizi değil, dünyayı da anlamak zorunda olduğumuz mesajını veriyor.

Bu mesaj bize değişim sürecimizi, hem Türkiye hem de dünyadaki ekonomi ve Endüstriyel Enerji / Elektrik sektöründeki gelişmeleri yakından izleyerek yönetmemiz gerektiğini söylüyor.

Mutlusan Ailesi olarak, Sosyal sorumluluk anlayışımız, eğitim, spor, çevre, sağlık konularındaki gelişme ve iyileşmeleri teşvik eden bir yaklaşımdır. Bu konularda, ilgili sivil toplum kuruluşlarıyla çalışmalarımız devam edecektir.

1983 yılında, bu ülkenin geleceğine güvenerek çıktığımız bu yolda zaman bizleri haklı çıkardı. Bugün 40.000 metrekaresel üretim tesisi ve 550 kişilik çalışan kadromuzla birlikte, bu ülkede doğmuş bir markayı yöneten bizler, hem Türkiye'nin hem de Mutlusan'ın dünyadaki geleceğine inanıyor ve buna güveniyoruz.

Her zaman söylediğimiz ve hayat felsefemiz olan cümleyi tekrar etmek isterim.

“ Biz, Çalışırken Mutluyuz...”

Dear Friends,

Our industrial story began with confidence in the sector and our country in our Karaköy Store in 1983. Despite the difficult circumstances, we believed in the future of Mutlusan. We have sowed the seeds of our great Mutlusan family that emerged today with production we started in limited quantities due to the circumstances and our long-term patience.

As the Mutlusan Family, we continue today with the first day's excitement about overcoming challenges, innovating, honest and responsible production, respect for our customers and investment passion.

In recent years we are experiencing a rapid change and growth process. We are trying to make our investments with new investments, technological renewal, institutionalization studies, restructuring, new markets and new products. Our company is constantly searching for growth opportunities and planning to increase its productivity. By supporting innovation, we are strengthening our technological infrastructure and enriching our human resources.

We aim to keep the success of the changing world by sustaining our traditional values.

Thanks to globalization, companies are able to reach their customers as if they were close to customers who are kilometers away.

Reaching out to people thousands of kilometers away in our products, we strive to add value to their lives. This situation get the message to us, We as a Turkey brand have to understand the world as well not only our country.

This message says us; we need to manage our change process by watching closely developments in the both Turkey and the world economic and industrial Energy / Electricity sector.

As a Mutlusan Family, Social responsibility is an approach that promotes improvements and improvements in education, sport, environment, health issues. In these matters, we will continue to work with the relevant civil society organizations.

In 1983, we were justified in this way when we came to rely on the future of this country. Today we manage a brand that is born in this country with a 40,000 square meter production facility and 550 employees and believe both Turkey's and the Mutlusan future of the world.

We always say, and I would like to repeat the sentence which is our life philosophy.

"We Are Happy at Work ..."

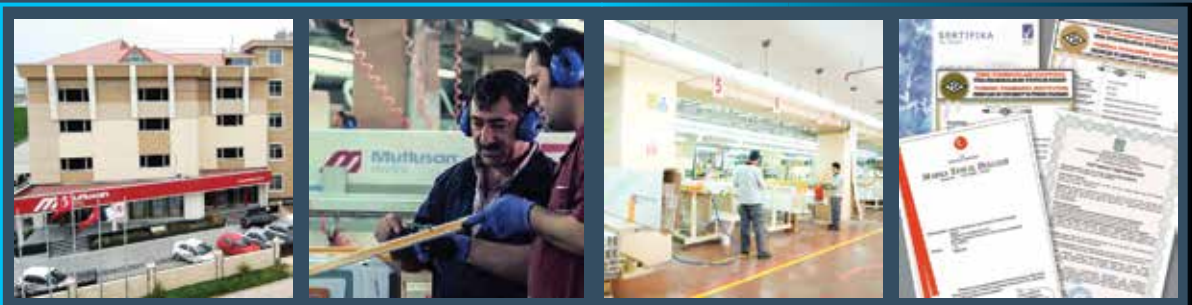



Rita

Elitra Plus

Candela

Candela Kids

Daria

Nemliyer • Wet Ground

Bron

Grup Prizler • Group Sockets



ANAHTAR GRUBU
SWITCHES & SOCKETS GROUP

**ANAHTAR
MEKANİZMA**
SWITCHES
MECHANISM

Mükemmel tasarımı
dış görünümü ve
yenilenen iç
mekanizması ile

KUSURSUZ ...

With its perfectly
designed exterior and
renewed interior
mechanics

PERFECT...

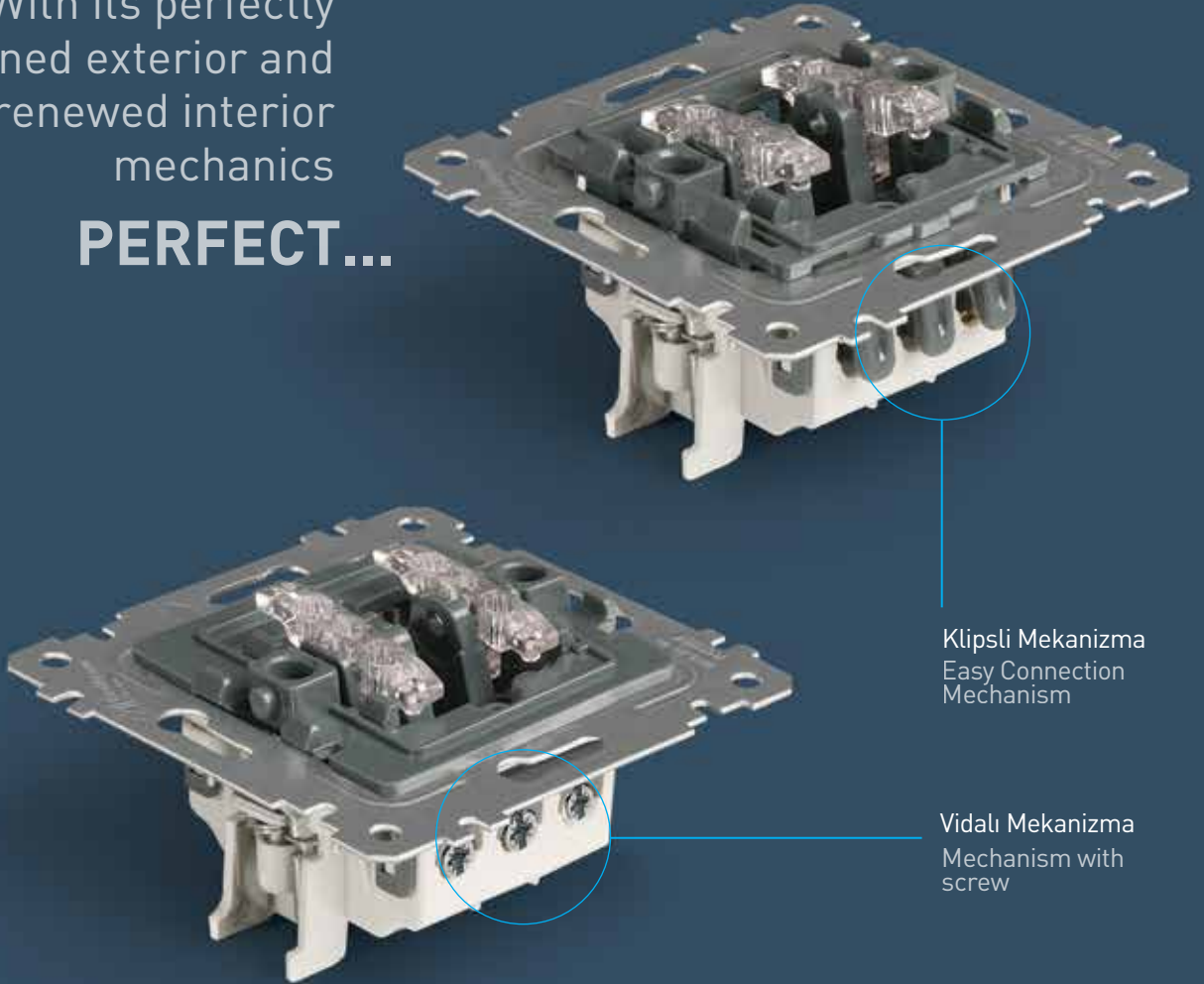

Ritā

SERISİ / SERIES

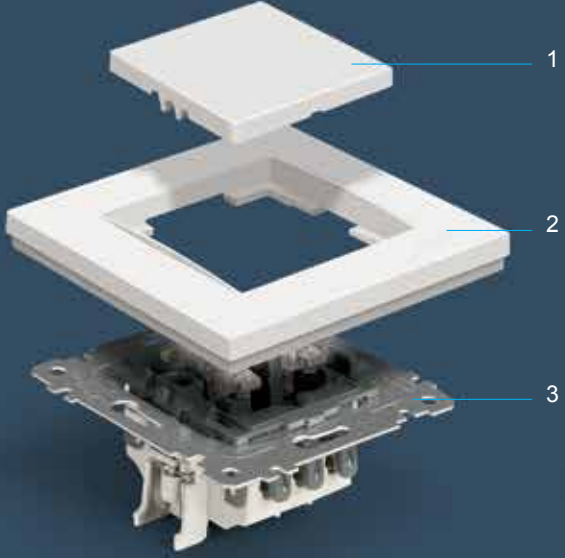

- 1 - Tuş / Plate
- 2- Çerçeve / Frame
- 3- Mekanizma / Mechanizm

Elitra Plus

SERISİ / SERIES

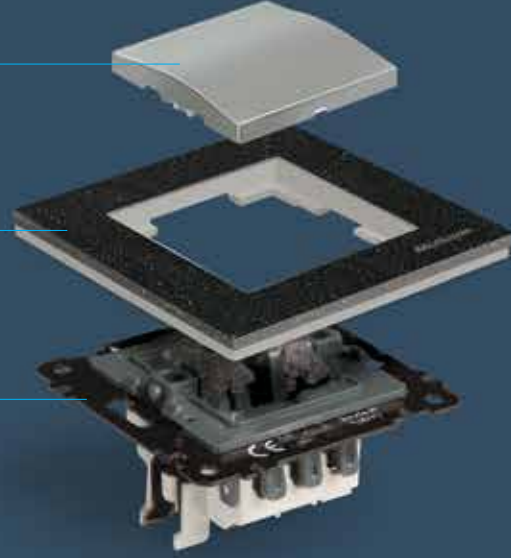

- 1 - Tuş / Plate
- 2- Çerçeve / Frame
- 3- Mekanizma / Mechanizm

Candelā

SERISİ / SERIES

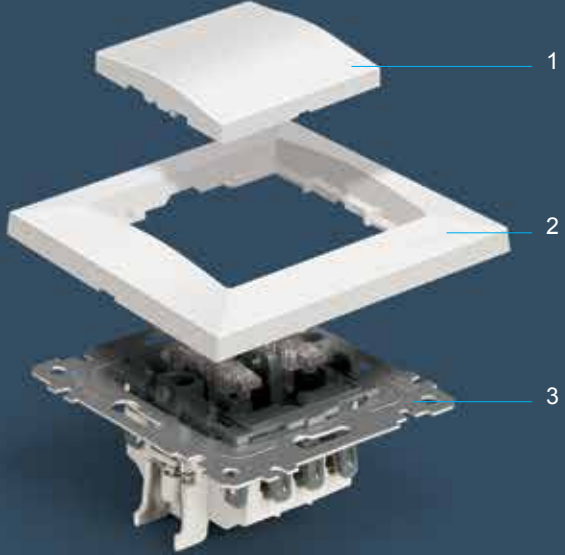

- 1 - Tuş / Plate
- 2- Çerçeve / Frame
- 3- Mekanizma / Mechanizm

Dariā

SERISİ / SERIES



- 1 - Tuş / Plate
- 2- Çerçeve / Frame
- 3- Mekanizma / Mechanizm

Ritā
SERİSİ
SERIES



Akılcı çözümler...

Teknolojik ürünleri ince detaylı tasarımlarla hayatınıza kattık, size keyfini çıkarmak kaldı.

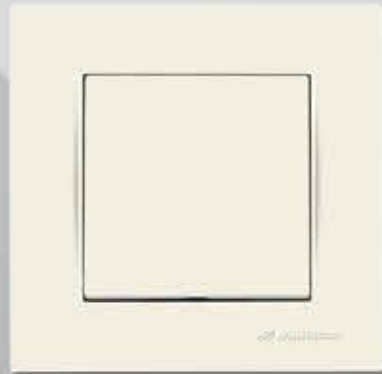
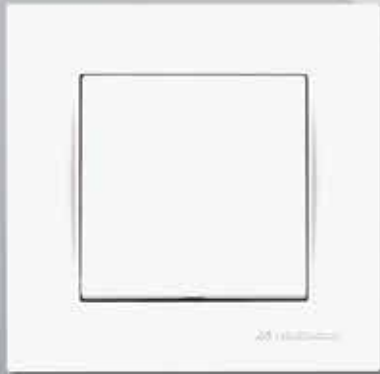

Pastel

PASTEL • PASTEL



Rational solutions ...

We bring Technological products with fine detail design to your life, it's up to you to enjoy.



Metallic

METALİK • METALLIC

Rita
SERİSİ
SERIES



Yeniliklerin müjdecisi...

Artık daha teknolojik bir hayat var...

Rita serisi yenilikçi ürünleri ile hayatınızı kolaylaştırmak için yanınızda...





The herald of innovation ...

Now there are more technological life ...
The Rita series is at your side to make your life easier with
innovative products ...



Ritā
ÇERÇEVELER
FRAMES

İKİLİ PRİZLER DOUBLE SOCKETS



ÇERÇEVELER

Tekliden altılıya kadar
çoklu anahtar ihtiyaçlarınızın
çözümü...

FRAMES

Multi-key solution for your
needs from single up to six...



TELEFON TUTUCU TELEPHONE HOLDER



YENİ
ÜRÜN
NEW



2200 800 00XX

RENK SEÇENEKLERİ COLORS OPTIONS

NATUREL • NATURAL



XX : 01 Beyaz • White



XX : 02 Krem • Cream

PASTEL • PASTEL



Çerçeve (XX)
03 Gri • Grey



Çerçeve (XX)
04 Kırmızı • Red



Çerçeve (XX)
06 Turuncu • Orange



Çerçeve (XX)
08 Sarı • Yellow



Çerçeve (XX)
09 Lacivert • Navy Blue



Çerçeve (XX)
10 Yeşil • Green



Çerçeve (XX)
11 Pembe • Pink



Çerçeve (XX)
12 Mavi • Blue



Çerçeve (XX)
25 Mor • Purple

METALİK • METALLIC



XX : 80
Antik altın • Antique gold



XX : 82 İnoks • Inox



XX : 83
Titanyum • Titanium



XX : 84 Siyah • Black



XX : 95 Füme • Smoked

AHŞAP DESEN • WOOD PATTERN



XX : 56 Kiraz • Cherry



XX : 57 Ceviz • Walnuts



XX : 58 Meşe • Oak

YATAY ÇERÇEVELER • HORIZONTAL FRAMES

2220 800 11 XX
1'li Çerçeve • 1 Gang frame



2220 800 12 XX
2'li Çerçeve • 2 Gang frame



2220 800 13 XX
3'lü Çerçeve • 3 Gang frame



2220 800 14 XX
4'lü Çerçeve • 4 Gang frame



2220 800 15 XX
5'li Çerçeve • 5 Gang frame



2220 800 16 XX
6'li Çerçeve • 6 Gang frame



DİKEY ÇERÇEVELER • VERTICAL FRAMES

2220 800 22 XX
2'li Çerçeve
2 Gang frame



2220 800 23 XX
3'lü Çerçeve
3 Gang frame



2220 800 24 XX
4'lü Çerçeve
4 Gang frame



2220 800 25 XX
5'li Çerçeve
5 Gang frame



2220 800 26 XX
6'li Çerçeve
6 Gang frame



Bu ürün kodlarında XX çerçeve rengini belirtmektedir.
XX specify frame color for these products.

Rita

TEKNİK BİLGİLER
TECHNICAL FEATURES

BOYUTLAR • DIMENSIONS

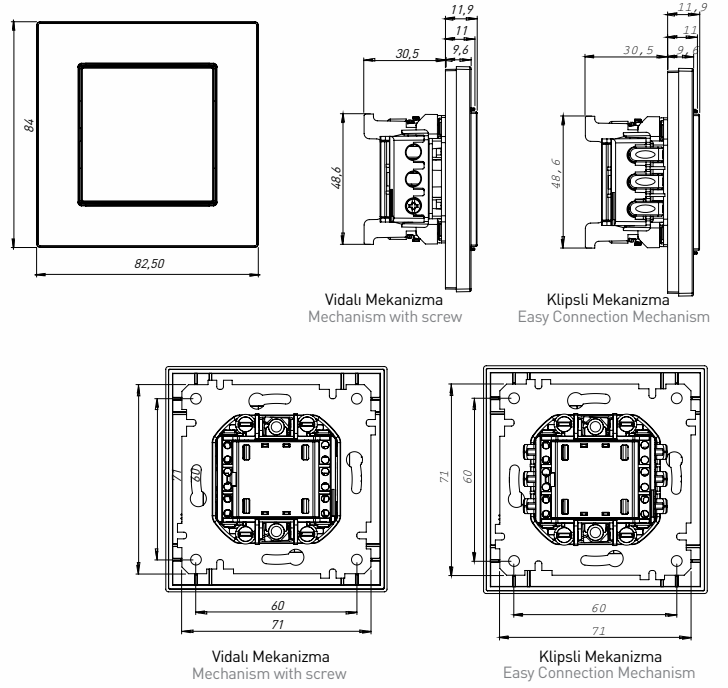

MEKANİZMA + TUŞ ÜRÜN LİSTESİ • MECHANISM + PLATE PRODUCT LIST

Kod / Code	Ürün Tanımı	Description
ANAHTAR GRUBU VİDALI		
SWITCH GROUP (WITH SCREW)		
2200 401 02XX	ANAHTAR (VİDALI)	ONE GANG ONE WAY SWITCH
2200 402 02XX	KOMÜTATÖR (VİDALI)	TWO GANG ONE WAY SWITCH
2200 403 02XX	VAVİEN(İKİ YOLLU ANAHTAR) (VİDALI)	ONE GANG TWO WAY SWITCH (VA-ET-VIENT)
2200 404 02XX	KOMÜTATÖR VAVİEN (VİDALI)	TWO GANG TWO WAY SWITCH (COMMUTATOR VEAVIEN)
2200 405 02XX	ÇİFT KUTUPLU ANAHTAR (VİDALI)	DOUBLE POLE SWITCH
2200 406 02XX	JALUZİ ANAHTARI-YAYLI (VİDALI)	BLIND SWITCH (CONTROL SWITCH)
2200 407 02XX	ÇAĞIRMA (LİGHT) (VİDALI)	ONE GANG ONE WAY SWITCH (LIGHT) (PUSH Plate)
2200 407 02XXK	KAPI OTOMATIĞI ANAHTARI (VİDALI)	DOOR SWITCH
2200 407 02XXZ	ZİL ANAHTARI (VİDALI)	BELL SWITCH
2200 408 02XX	DEVİYATÖR (ARA VAVİEN) (VİDALI)	ONE GANG INTERMEDIATE SWITCH
2200 409 02XX	ÜÇLÜ ANAHTAR (VİDALI)	THREE GANG ONE WAY SWITCH
2200 411 02XX	ŞOFBEN ANAHTARI (VİDALI)	HEATER SWITCH
2200 415 02XX	IŞIKLI ANAHTAR (220V) (VİDALI)	ILLUMINATED ONE (220V)GANG ONE WAY SWITCH
2200 416 02XX	IŞIKLI VAVİEN (220V) (VİDALI)	ILLUMINATED ONE GANG TWO WAY
2200 417 02XX	IŞIKLI ÇAĞIRMA(220V) (VİDALI)	ILLUMINATED ONE GANG ONE WAY (PUSH Plate) SWITCH)
2200 418 02XX	IŞIKLI ETİKETLİ ANAHTAR (220V) (VİDALI)	ILLUMINATED 1 G 1 W SWITCH WITH LABEL
2200 419 02XX	IŞIKLI ETİKETLİ ÇAĞIRMA (220V) (VİDALI)	ILLUMINATED 1 G 1 W SWITCH WITH LABEL (PUSH Plate)
2200 422 02XX	IŞIKLI ZİL ÇAĞIRMA (12V) (VİDALI)	ILLUMINATED ONE GANG ONE WAY SWITCH (PUSH Plate)
2200 426 02XX	IŞIKLI KOMÜTATÖR (VİDALI)	ILLUMINATED TWO GANG ONE WAY SWITCH (220V)

ANAHTAR GRUBU KLİPSLİ		
SWITCH GROUP EASY CONNECTION		
2200 401 01XX	ANAHTAR (KLİPSLİ)	ONE GANG ONE WAY SWITCH
2200 402 01XX	KOMÜTATÖR (KLİPSLİ)	TWO GANG ONE WAY SWITCH
2200 403 01XX	VAVİEN(İKİ YOLLU ANAHTAR) (KLİPSLİ)	ONE GANG TWO WAY SWITCH (VA-ET-VIENT)
2200 404 01XX	KOMÜTATÖR VAVİEN (KLİPSLİ)	TWO GANG TWO WAY SWITCH (COMMUTATOR VEAVIEN)
2200 405 01XX	ÇİFT KUTUPLU ANAHTAR (KLİPSLİ)	DOUBLE POLE SWITCH
2200 406 01XX	JALUZİ ANAHTARI-YAYLI (KLİPSLİ)	BLIND SWITCH (CONTROL SWITCH)
2200 407 01XX	ÇAĞIRMA (LİGHT) (KLİPSLİ)	ONE GANG ONE WAY SWITCH (LIGHT) (PUSH Plate)
2200 407 01XXK	KAPI OTOMATIĞI ANAHTARI (KLİPSLİ)	DOOR SWITCH
2200 407 01XXZ	ZİL ANAHTARI (KLİPSLİ)	BELL SWITCH
2200 408 01XX	DEVİYATÖR (ARA VAVİEN) (KLİPSLİ)	ONE GANG INTERMEDIATE SWITCH
2200 409 01XX	ÜÇLÜ ANAHTAR (KLİPSLİ)	THREE GANG ONE WAY SWITCH
2200 415 01XX	IŞIKLI ANAHTAR (220V) (KLİPSLİ)	ILLUMINATED ONE (220V)GANG ONE WAY SWITCH
2200 416 01XX	IŞIKLI VAVİEN (220V) (KLİPSLİ)	ILLUMINATED ONE GANG TWO WAY
2200 417 01XX	IŞIKLI ÇAĞIRMA(220V) (KLİPSLİ)	ILLUMINATED ONE GANG ONE WAY (PUSH Plate) SWITCH)
2200 418 01XX	IŞIKLI ETİKETLİ ANAHTAR (220V) (KLİPSLİ)	ILLUMINATED 1 G 1 W SWITCH WITH LABEL
2200 419 01XX	IŞIKLI ETİKETLİ ÇAĞIRMA (220V) (KLİPSLİ)	ILLUMINATED 1 G 1 W SWITCH WITH LABEL (PUSH Plate)
2200 422 01XX	IŞIKLI ZİL ÇAĞIRMA (12V) (KLİPSLİ)	ILLUMINATED ONE GANG ONE WAY SWITCH (PUSH Plate)
2200 426 01XX	IŞIKLI KOMÜTATÖR (KLİPSLİ)	ILLUMINATED TWO GANG ONE WAY SWITCH (220V)

MEKANİZMA + TUŞ ÜRÜN LİSTESİ • MECHANISM + PLATE PRODUCT LIST

Kod / Code	Ürün Tanımı	Description
------------	-------------	-------------

DİMMER GRUBU

DIMMER GROUP

2200 440 02XX	IŞIKLI DİMMER (600 W)	RL ILLUMINATED DIMMER (600 W)
2200 443 02XX	IŞIKLI DİMMER CE'Lİ (600 W) FİLTRELİ	RL ILLUMINATED DIMMER (600 W CE)
2200 444 02XX	IŞIKLI DİMMER (1000 W)	RL ILLUMINATED DIMMER (1000 W)
2200 445 02XX	RLC DİMMER (10-300W)	RLC DIMMER (10-300W)

ELEKTRONİK GRUBU

ELECTRONIC GROUP

2200 450 02XX	ENERGY SAVER GECİKMESİZ IŞIKLI	ENERGY SAVER ILLUMINATED
2200 452 02XX	ENERGY SAVER GECİKMELİ IŞIKLI	ENERGY SAVER WITH DELAY
2200 470 02XX	MÜZİK YAYIN ANAHTARI	AUDIO SWITCH
2200 480 02XX	HOPARLÖR PRİZİ	SPEAKER SOCKET
2200 485 02XX	UYARI ZİLİ	WARNING SWITCH
2200 495 02XX	HAREKET SENSÖRÜ	MOVEMENT SENSOR

PRİZ GRUBU

SOCKET GROUP

2200 600 02XX	TOPRAKLI PRİZ	EARTHED SOCKET OUTLET
2200 601 02XX	TOPRAKSIZ PRİZ	SOCKET OUTLET NON- EARTHED
2200 605 02XX	TOPRAKLI PRİZ (ÇOCUK KORUMALI)	EARTHED SOCKET WITH CHILD PROTECTION
2200 606 02XX	TOPRAKSIZ PRİZ (ÇOCUK KORUMALI)	SOCKET OUTLET WITH CHILD PROTECTION NON EARTHED
2200 610 02XX	KAPAKLI TOPRAKLI PRİZ	EARTHED SOCKET WITH COVER
2200 611 02XX	KAPAKLI TOPRAKLI PRİZ (ÇOCUK KORUMALI)	EARTHED SOCKET WITH CHILD PROTECTION COVER
2200 615 02XX	UPS (FRANSIZ) PRİZİ	UPS (FRENCH) SOCKET (EARTHED SOCKET WITH PIN)
2200 616 02XX	UPS (FRANSIZ) PRİZİ (ÇOCUK KORUMALI)	UPS (FRENCH) SOCKET (CHILD PROTECTION)
2200 617 02XX	UPS KAPAKLI(FRANSIZ) PRİZİ	UPS SOCKET (FRENCH) WITH COVER
2200 618 02XX	UPS (FRANSIZ)KAP. TOPRAKLI PRİZ (ÇOC.KRM)	UPS SOCKET (FRENCH) WITH COVER (CHILD PROTECTION)
2200 200 02XX	İKİLİ TOPRAKLI PRİZ (PORSELEN)	DOUBLE SOCKET EARTHED PORCELAIN
2200 201 02XX	İKİLİ TOPRAKSIZ PRİZ (PORSELEN)	DOUBLE SOCKET (NON EARTHED) PORCELAIN
2200 202 02XX	İKİLİ TOPRAKLI PRİZ	DOUBLE SOCKET EARTHED
2200 203 02XX	İKİLİ TOPRAKSIZ PRİZ	DOUBLE SOCKET (NON EARTHED)
2200 215 02XX	İKİLİ UPS PRİZ	DOUBLE SOCKET WITH UPS (FRENCH)
2200 448 02XX	TEKLİ USB ŞARJ PRİZİ	USB CHARGE SOCKET
2200 449 02XX	İKİLİ USB ŞARJ PRİZİ	USB CHARGE TWO SOCKET

İLETİŞİM GRUBU

COMMUNICATIONS GROUP

2200 125 01XX	TELEFON PRİZİ 1*RJ12 (CAT 3)	TELEPHONE SOCKET 1*RJ12 (CAT 3)
2200 126 01XX	TELEFON PRİZİ 2*RJ12 (CAT 3)	TELEPHONE SOCKET 2*RJ12 (CAT 3)
2200 128 01XX	ETİKETLİ TELEFON DATA PRİZ (KON.SÜZ)	TELEPHONE DATA SOCKET WITH LABEL (WITHOUT CONNECTOR)
2200 135 01XX	DATA PRİZ 1*RJ45 (KONNEKTÖRSÜZ)	DATA SOCKET 1*RJ45 (WITHOUT CONNECTOR)
2200 136 01XX	DATA PRİZ 1*RJ45 (CAT 5E)	DATA SOCKET 1*RJ45 (CAT 5E)
2200 137 01XX	DATA PRİZ 2*RJ45 (KONNEKTÖRSÜZ)	DATA SOCKET 2*RJ45 (WITHOUT CONNECTOR)
2200 138 01XX	DATA PRİZ 2*RJ45 (CAT 5E)	DATA SOCKET 2*RJ45 (CAT 5E)
2200 139 01XX	DATA PRİZ (RJ12 CAT 3+CAT 5 E)	DATA SOCKET (RJ12 CAT 3+CAT 5 E)
2200 140 01XX	DATA PRİZ 1*RJ45 (CAT 6)	DATA SOCKET 1*RJ45 (CAT 6)
2200 141 01XX	DATA PRİZ 2*RJ45 (CAT 6)	DATA SOCKET 2*RJ45 (CAT 6)
2200 455 01XX	DATA PRİZ 1*USB	DATA SOCKET 1* USB
2200 456 01XX	DATA PRİZ 2*USB	DATA SOCKET 2* USB
2200 457 01XX	DATA PRİZ 1*HDMI	DATA SOCKET 1*HDMI
2200 458 01XX	DATA PRİZ 2*HDMI	DATA SOCKET 2*HDMI
2200 459 01XX	DATA PRİZ 1*USB / 1*HDMI	DATA SOCKET 1*USB / 1*HDMI
2200 460 01XX	VGA PRİZ	VGA SOCKET
2200 121 02XX	KÖR KAPAK	BLIND COVER

TV / SAT GRUBU

TV / SAT GROUP

2200 156 02XX	TV / SAT PRİZİ (GEÇİŞLİ) 4DB/F KON.	TV / SAT SOCKET (THROUGH) 4DB/F KON.
2200 157 02XX	TV / SAT PRİZİ (SONLU)	TV / SAT SOCKET (DEAD-END)
2200 166 01XX	SAT PRİZİ (GEÇİŞLİ) 4DB/F KON.	SAT SOCKET (THROUGH)
2200 167 01XX	SAT PRİZİ (SONLU)	SAT SOCKET (DEAD-END)
2200 170 01XX	TV PRİZİ (GEÇİŞLİ) 11 DB	TV SOCKET (THROUGH) 11 DB
2200 171 01XX	TV PRİZİ (SONLU)	TV SOCKET (DEAD-END)
2200 172 01XX	TV PRİZİ F DİŞİ	TV SOCKET F FEMALE

SIVAÜSTÜ KASA

SURFACE BOX

2100 000 11XX	SIVAÜSTÜ KASA	SURFAC MOUNTED BOX
---------------	---------------	--------------------

AKSESUAR

ACCESSORIES

2200 800 00XX	TELEFON TUTUCU	TELEPHONE HOLDER
---------------	----------------	------------------

ELEKTRONİK ELECTRONIC



RCA PRİZ



USB PRINTER PRİZ



SPEAKHONE PRİZ



XLR DİŞİ PRİZ



XLR ERKEK PRİZ



XLR 3,5 SES JAKI

ÜRÜN LİSTESİ • PRODUCT LIST

Kod / Code	Ürün Tanımı	Description
2200 250 01XX	RİTA SPEAKHONE PRİZ	RITA SPEAKHONE
2200 251 01XX	RİTA RCA PRİZ	RITA RCA SOCKET
2200 252 01XX	RİTA 3,5 SES JAKI	RITA 3,5 AUDIO CONNECTOR
2200 253 01XX	RİTA XLR ERKEK PRİZ	RITA XLR MALE SOCKET
2200 254 01XX	RİTA XLR DİŞİ PRİZ	RITA XLR FEMALE SOCKET
2200 255 01XX	RİTA USB PRINTER PRİZ	RITA USB PRINTER SOCKET
2100 250 01XX	SPEAKHONE PRİZ	SPEAKHOMNE SOCKET
2100 251 01XX	RCA PRİZ	RCA SOCKET
2100 252 01XX	3,5 SES JAKI	3,5 AUDIO CONNECTOR
2100 253 01XX	XLR ERKEK PRİZ	XLR MALE SOCKET
2100 254 01XX	XLR DİŞİ PRİZ	XLR FEMALE SOCKET
2100 255 01XX	USB PRINTER PRİZ	USB PRINTER SOCKET



ÜRÜN LİSTESİ • PRODUCT LIST

Kod / Code	Ürün Tanımı	Description
2100 852 0000	30A + 16A ENERGY SAVER ROLE PCB (VRF/FC)	30A+16A ENERGY SAVER RELAY PCB(VRF/FC)
2100 853 0000	3X16A ENERGY SAVER ROLE PCB (VRF/FC)	3X16A ENERGY SAVER - DND RELAY PCB (VRF/FC)
2100 854 0000	3X16A ENERGY SAVER - DND ROLE PCB (VRF/FC)	30A+2X16A ENERGY SAVER - DND RELAY PCB (VRF/FC)
2100 855 0000	30A+2X16A ENERGY SAVER - DND ROLE PCB (VRF/FC)	30A+2X16A ENERGY SAVER - DND RELAY PCB (VRF/FC)
2110 052 00XX	ENERGY SAVER KAPAK	ENERGY SAVER COVER
2220 010 01XX	RİTA OTEL UYARI İÇ ÜNİTESİ KOMÜTATÖRÜ (MEKANİK) IŞIKLI (KLİPSLİ)	RITA HOTEL INTERIOR WARNING UNIT 2 GANG 1 WAY - MECHANICAL ILLUMINATED WITH (EASY CONNECTION)
2220 010 02XX	RİTA OTEL UYARI İÇ ÜNİTESİ KOMÜTATÖRÜ (MEKANİK) IŞIKLI (VİDALI)	RITA HOTEL INTERIOR WARNING UNIT 2 GANG 1 WAY - MECHANICAL ILLUMINATED WITH (WITH SCREW)
2200 412 01XX	RİTA MEKANİZMA+TUŞ İMPLUS ANAHTAR (KLİPSLİ)	RITA MECHANISM+PLATE İMPLUS 1 GANG 1 WAY (EASY CONNECTION)
2200 412 02XX	RİTA MEKANİZMA+TUŞ İMPLUS ANAHTAR (VİDALI)	RITA MECHANISM+PLATE İMPLUS 1 GANG 1 WAY (WITH SCREW)
2200 423 01XX	RİTA MEKANİZMA+TUŞ İMPLUS KOMÜTATÖR (KLİPSLİ)	RITA MECHANISM + PLATE İMPLUS 2 GANG 1 WAY (EASY CONNECTION)
2200 423 02XX	RİTA MEKANİZMA+TUŞ İMPLUS KOMÜTATÖR (VİDALI)	RITA MECHANISM + PLATE İMPLUS 2 GANG 1 WAY (WITH SCREW)
2200 424 01XX	RİTA MEKANİZMA+TUŞ İMPLUS IŞIKLI ANAHTAR (KLİPSLİ)	RITA MECHANISM + PLATE İMPLUS ILLUMINATED 1 GANG 1 WAY SWITCH (EASY CONNECTION)
2200 424 02XX	RİTA MEKANİZMA+TUŞ İMPLUS IŞIKLI ANAHTAR (VİDALI)	RITA MECHANISM + PLATE İMPLUS ILLUMINATED 1 GANG 1 WAY SWITCH (WITH SCREW)
2200 427 01XX	RİTA MEKANİZMA+TUŞ İMPLUS IŞIKLI KOMÜTATÖR (KLİPSLİ)	RITA MECHANISM + PLATE İMPLUS ILLUMINATED 2 GANG 1 WAY (EASY CONNECTION)
2200 427 02XX	RİTA MEKANİZMA+TUŞ İMPLUS IŞIKLI KOMÜTATÖR (VİDALI)	RITA MECHANISM + PLATE İMPLUS ILLUMINATED 2 GANG 1 WAY (WITH SCREW)
2125 010 0101	OTEL UYARI İÇ ÜNİTESİ KOMÜTATÖRÜ (MEKANİK) IŞIKLI (KLİPSLİ)	HOTEL INTERIOR WARNING UNIT 2 GANG 1 WAY - MECHANICAL ILLUMINATED WITH (EASY CONNECTION)
2100 012 01XX	İMPLUS ANAHTAR (KLİPSLİ)	İMPLUS ONE GANG ONE WAY SWITCH (EASY CONNECTION)
2100 423 01XX	İMPLUS KOMÜTATÖR (KLİPSLİ)	İMPLUS TWO GANG ONE WAY SWITCH (EASY CONNECTION)
2100 424 01XX	İMPLUS IŞIKLI ANAHTAR (220 V) (KLİPSLİ)	İMPLUS ILLUMINATED 1 GANG 1 WAY SWITCH (220V) (EASY CONNECTION)
2100 427 01XX	İMPLUS IŞIKLI KOMÜTATÖR (KLİPSLİ)	İMPULSE 1 GANG 1 WAY SWITCH (EASY CONNECTION)

ElitraPlus

SERİSİ
SERIES



Göz alıcı ...

Usta elinden çıkmış, incelikle düşünülmüş nadir bir mücevher gibi göz alacak...



Chrome

KROM • CHROME



Eye-catching ...

Eye-catching as a rare jewel of master craftsmanship, delicately conceived...



ElitraPlus

SERİSİ
SERIES



Seçkin ürünler...

Formunu ve desenini doğanın eşsiz görünümünden alan sadeliği ile ön plana çıkan seçkin ürünler...



MARBLE

MERMER • MARBLE



Excellent products...

Excellent products that come to the forefront with the design of the form and the design with the unique appearance of nature ...



Elitra|Plus

SERİSİ
SERIES



Sıradanlığa meydan okuyun...

Modern mekanların vazgeçilmez üyeleri,
farklı beğenilere cevap verebilmek için tasarlandı...

Challenge ordinariness...

Indispensable members of
modern spaces are
designed to respond to
different tastes ...



Elitra|Plus

ÇERÇEVELER
FRAMES

ÇERÇEVELER

Tekliden altılıya kadar çoklu anahtar ihtiyaçlarınızın çözümü...

FRAMES

Multi-key solution for your needs from single up to six...

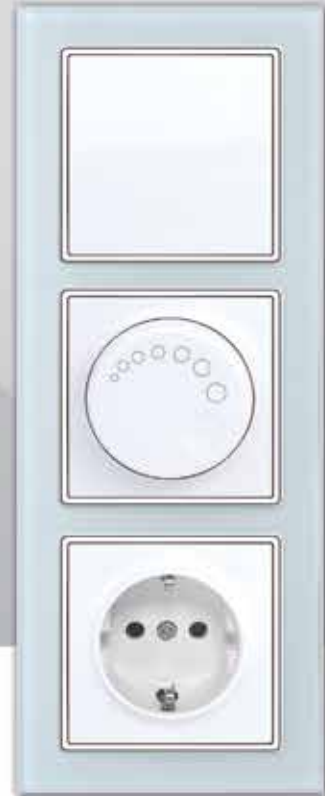

RENK SEÇENEKLERİ COLORS OPTIONS

Elitra Glass



Cerçeve (XX) : 11 Beyaz
Tuş (YY) : 01 Beyaz
Frame (XX) : 11 White
Plate (YY) : 01 White

Cerçeve (XX) : 14 Siyah
Tuş (YY) : 92 Gümüş
Frame (XX) : 14 Black
Plate (YY) : 92 Silver

Elitra Chrome



Cerçeve (XX) : 21 Krom
Tuş (YY) : 95 Füme
Frame (XX) : 21 Chrome
Plate (YY) : 95 Smoked

Cerçeve (XX) : 22 Altın
Tuş (YY) : 90 Saten
Frame (XX) : 22 Gold
Plate (YY) : 90 Satin

Cerçeve (XX) : 24 Paslanmaz Çelik
Tuş (YY) : 95 Füme
Frame (XX) : 24 Stainless Stell
Plate (YY) : 95 Smoked



Cerçeve (XX) : 25 Parlak Füme
Tuş (YY) : 92 Gümüş
Frame (XX) : 25 Bright Smoked
Plate (YY) : 92 Silver

Cerçeve (XX) : 25 Parlak Füme
Tuş (YY) : 95 Füme
Frame (XX) : 25 Bright Smoked
Plate (YY) : 95 Smoked

Cerçeve (XX) : 27 Mat Alüminyum
Tuş (YY) : 95 Füme
Frame (XX) : 27 Mat Aluminium
Plate (YY) : 95 Smoked

Cerçeve (XX) : 28 Mat Saten
Tuş (YY) : 90 Saten
Frame (XX) : 28 Mat Satin
Plate (YY) : 90 Satin

Elitra Wood



Cerçeve (XX) : 32 Kayın
Tuş (YY) : 92 Gümüş
Frame (XX) : 32 Beech
Plate (YY) : 92 Silver

Cerçeve (XX) : 33 Kiraz
Tuş (YY) : 90 Saten
Frame (XX) : 33 Cherry
Plate (YY) : 90 Satin

Cerçeve (XX) : 34 Venge
Tuş (YY) : 92 Gümüş
Frame (XX) : 34 Venge
Plate (YY) : 92 Silver

Elitra Marble



Cerçeve (XX) : 42 Black Quartz
Tuş (YY) : 92 Gümüş
Frame (XX) : 42 Black Quartz
Plate (YY) : 92 Silver

Cerçeve (XX) : 43 Sand Stone
Tuş (YY) : 92 Gümüş
Frame (XX) : 43 Sand Stone
Plate (YY) : 92 Silver

Elitra Ale



Cerçeve (XX) : 51 Natural
Tuş (YY) : 95 Füme
Frame (XX) : 51 Natural
Plate (YY) : 92 Smoked

Cerçeve (XX) : 52 Saten
Tuş (YY) : 90 Saten
Frame (XX) : 52 Satin
Plate (YY) : 90 Satin

Cerçeve (XX) : 53 Mat Füme
Tuş (YY) : 92 Gümüş
Frame (XX) : 53 Mat Smoked
Plate (YY) : 92 Silver

YATAY ÇERÇEVELER • HORIZONTAL FRAMES

2170 8XX 11YY
1'li Çerçeve • 1 Gang frame



2170 8XX 12YY
2'li Çerçeve • 2 Gang frame



2170 8XX 13YY
3'lü Çerçeve • 3 Gang frame



2170 8XX 14YY
4'lü Çerçeve • 4 Gang frame



2170 8XX 15YY
5'li Çerçeve • 5 Gang frame



2170 8XX 16YY
6'li Çerçeve • 6 Gang frame



DİKEY ÇERÇEVELER • VERTICAL FRAMES

2170 8XX 22YY
2'li Çerçeve
2 Gang frame



2170 8XX 23YY
3'lü Çerçeve
3 Gang frame



2170 8XX 24YY
4'lü Çerçeve
4 Gang frame

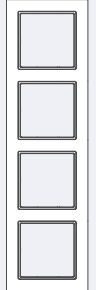

2170 8XX 25YY
5'li Çerçeve
5 Gang frame



2170 8XX 26YY
6'li Çerçeve
6 Gang frame



Bu ürün kodlarında XX çerçeve rengini YY kordon rengini belirtmektedir.
For these products, XX indicates frame color, YY cord color.

Elitra Plus

TEKNİK BİLGİLER
TECHNICAL FEATURES

BOYUTLAR • DIMENSIONS

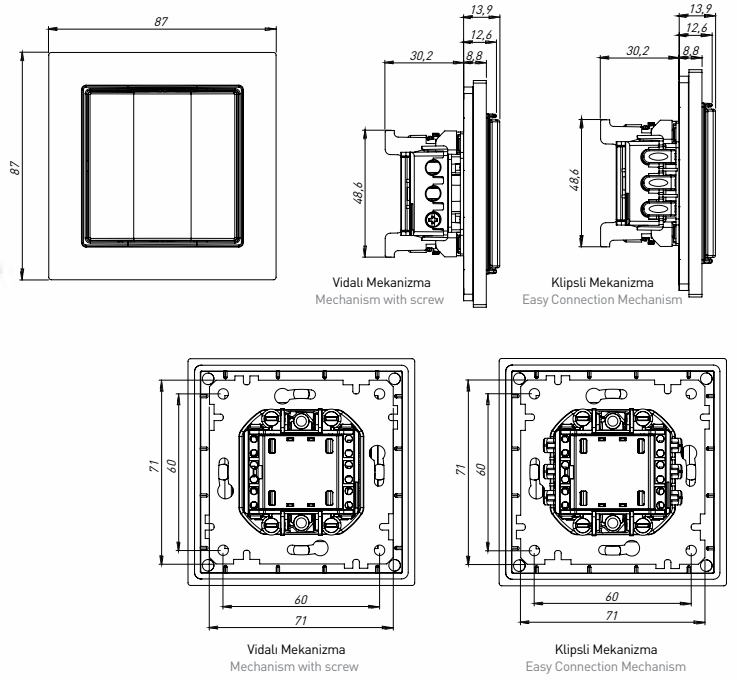

MEKANİZMA + TUŞ ÜRÜN LİSTESİ • MECHANISM + PLATE PRODUCT LIST

Kod / Code	Ürün Tanımı	Description
ANAHTAR GRUBU VİDALI		
SWITCH GROUP (WITH SCREW)		
2270 401 02XX	ANAHTAR (VİDALI)	ONE GANG ONE WAY SWITCH
2270 402 02XX	KOMÜTATÖR (VİDALI)	TWO GANG ONE WAY SWITCH
2270 403 02XX	VAVİEN(İKİ YOLLU ANAHTAR) (VİDALI)	ONE GANG TWO WAY SWITCH (VA-ET-VIENT)
2270 404 02XX	KOMÜTATÖR VAVİEN (VİDALI)	TWO GANG TWO WAY SWITCH (COMMUTATOR VEAVIEN)
2270 405 02XX	ÇİFT KUTUPLU ANAHTAR (VİDALI)	DOUBLE POLE SWITCH
2270 406 02XX	JALUZİ ANAHTARI-YAYLI (VİDALI)	BLIND SWITCH (CONTROL SWITCH)
2270 407 02XX	ÇAĞIRMA (LİGHT) (VİDALI)	ONE GANG ONE WAY SWITCH (LIGHT) (PUSH Plate)
2270 407 02XXK	KAPI OTOMATIĞI ANAHTARI (VİDALI)	DOOR SWITCH
2270 407 02XXZ	ZİL ANAHTARI (VİDALI)	BELL SWITCH
2270 408 02XX	DEVİYATÖR (ARA VAVİEN) (VİDALI)	ONE GANG INTERMEDIATE SWITCH
2270 409 02XX	ÜÇLÜ ANAHTAR (VİDALI)	THREE GANG ONE WAY SWITCH
2270 411 02XX	ŞOFBEN ANAHTARI (VİDALI)	HEATER SWITCH
2270 415 02XX	IŞIKLI ANAHTAR (220V) (VİDALI)	ILLUMINATED ONE (220V)GANG ONE WAY SWITCH
2270 416 02XX	IŞIKLI VAVİEN (220V) (VİDALI)	ILLUMINATED ONE GANG TWO WAY
2270 417 02XX	IŞIKLI ÇAĞIRMA(220V) (VİDALI)	ILLUMINATED ONE GANG ONE WAY (PUSH Plate) SWITCH)
2270 418 02XX	IŞIKLI ETİKETLİ ANAHTAR (220V) (VİDALI)	ILLUMINATED 1 G 1 W SWITCH WITH LABEL
2270 419 02XX	IŞIKLI ETİKETLİ ÇAĞIRMA (220V) (VİDALI)	ILLUMINATED 1 G 1 W SWITCH WITH LABEL (PUSH Plate)
2270 422 02XX	IŞIKLI ZİL ÇAĞIRMA (12V) (VİDALI)	ILLUMINATED ONE GANG ONE WAY SWITCH (PUSH Plate)
2270 426 02XX	IŞIKLI KOMÜTATÖR (VİDALI)	ILLUMINATED TWO GANG ONE WAY SWITCH (220V)
ANAHTAR GRUBU KLİPSLİ		
SWITCH GROUP EASY CONNECTION		
2270 401 01XX	ANAHTAR (KLİPSLİ)	ONE GANG ONE WAY SWITCH
2270 402 01XX	KOMÜTATÖR (KLİPSLİ)	TWO GANG ONE WAY SWITCH
2270 403 01XX	VAVİEN(İKİ YOLLU ANAHTAR) (KLİPSLİ)	ONE GANG TWO WAY SWITCH (VA-ET-VIENT)
2270 404 01XX	KOMÜTATÖR VAVİEN (KLİPSLİ)	TWO GANG TWO WAY SWITCH (COMMUTATOR VEAVIEN)
2270 405 01XX	ÇİFT KUTUPLU ANAHTAR (KLİPSLİ)	DOUBLE POLE SWITCH
2270 406 01XX	JALUZİ ANAHTARI-YAYLI (KLİPSLİ)	BLIND SWITCH (CONTROL SWITCH)
2270 407 01XX	ÇAĞIRMA (LİGHT) (KLİPSLİ)	ONE GANG ONE WAY SWITCH (LIGHT) (PUSH Plate)
2270 407 01XXK	KAPI OTOMATIĞI ANAHTARI (KLİPSLİ)	DOOR SWITCH
2270 407 01XXZ	ZİL ANAHTARI (KLİPSLİ)	BELL SWITCH
2270 408 01XX	DEVİYATÖR (ARA VAVİEN) (KLİPSLİ)	ONE GANG INTERMEDIATE SWITCH
2270 409 01XX	ÜÇLÜ ANAHTAR (KLİPSLİ)	THREE GANG ONE WAY SWITCH
2270 415 01XX	IŞIKLI ANAHTAR (220V) (KLİPSLİ)	ILLUMINATED ONE (220V)GANG ONE WAY SWITCH
2270 416 01XX	IŞIKLI VAVİEN (220V) (KLİPSLİ)	ILLUMINATED ONE GANG TWO WAY
2270 417 01XX	IŞIKLI ÇAĞIRMA(220V) (KLİPSLİ)	ILLUMINATED ONE GANG ONE WAY (PUSH Plate) SWITCH)
2270 418 01XX	IŞIKLI ETİKETLİ ANAHTAR (220V) (KLİPSLİ)	ILLUMINATED 1 G 1 W SWITCH WITH LABEL
2270 419 01XX	IŞIKLI ETİKETLİ ÇAĞIRMA (220V) (KLİPSLİ)	ILLUMINATED 1 G 1 W SWITCH WITH LABEL (PUSH Plate)
2270 422 01XX	IŞIKLI ZİL ÇAĞIRMA (12V) (KLİPSLİ)	ILLUMINATED ONE GANG ONE WAY SWITCH (PUSH Plate)
2270 426 01XX	IŞIKLI KOMÜTATÖR (KLİPSLİ)	ILLUMINATED TWO GANG ONE WAY SWITCH (220V)

MEKANİZMA + TUŞ ÜRÜN LİSTESİ • MECHANISM + PLATE PRODUCT LIST

Kod / Code	Ürün Tanımı	Description
DİMMER GRUBU		DIMMER GROUP
2270 440 02XX	IŞIKLI DİMMER (600 W)	RL ILLUMINATED DIMMER (600 W)
2270 443 02XX	IŞIKLI DİMMER CE'Lİ (600 W) FİLTRELİ	RL ILLUMINATED DIMMER (600 W CE)
2270 444 02XX	IŞIKLI DİMMER (1000 W)	RL ILLUMINATED DIMMER (1000 W)
2270 445 02XX	RLC DİMMER (10-300W)	RLC DIMMER (10-300W)
ELEKTRONİK GRUBU		ELECTRONIC GROUP
2270 450 02XX	ENERGY SAVER GECİKMESİZ IŞIKLI	ENERGY SAVER ILLUMINATED
2270 452 02XX	ENERGY SAVER GECİKMELİ IŞIKLI	ENERGY SAVER WITH DELAY
2270 470 02XX	MÜZİK YAYIN ANAHTARI	AUDIO SWITCH
2270 480 02XX	HOPARLÖR PRİZİ	SPEAKER SOCKET
2270 485 02XX	UYARI ZİLİ	WARNING SWITCH
2270 495 02XX	HAREKET SENSÖRÜ	MOVEMENT SENSOR
PRİZ GRUBU		SOCKET GROUP
2270 600 02XX	TOPRAKLI PRİZ	EARTHED SOCKET OUTLET
2270 601 02XX	TOPRAKSIZ PRİZ	SOCKET OUTLET NON- EARTHED
2270 605 02XX	TOPRAKLI PRİZ (ÇOCUK KORUMALI)	EARTHED SOCKET WITH CHILD PROTECTION
2270 606 02XX	TOPRAKSIZ PRİZ (ÇOCUK KORUMALI)	SOCKET OUTLET WITH CHILD PROTECTION NON EARTHED
2270 610 02XX	KAPAKLI TOPRAKLI PRİZ	EARTHED SOCKET WITH COVER
2270 611 02XX	KAPAKLI TOPRAKLI PRİZ (ÇOCUK KORUMALI)	EARTHED SOCKET WITH CHILD PROTECTION WITH COVER
2270 615 02XX	UPS (FRANSIZ) PRİZİ	UPS (FRENCH) SOCKET (EARTHED SOCKET WITH PIN)
2270 616 02XX	UPS (FRANSIZ) PRİZİ (ÇOCUK KORUMALI)	UPS (FRENCH) SOCKET (CHILD PROTECTION)
2270 617 02XX	UPS KAPAKLI(FRANSIZ) PRİZİ	UPS SOCKET (FRENCH) WITH COVER
2270 618 02XX	UPS (FRANSIZ)KAP. TOPRAKLI PRİZ (ÇOC.KRM)	UPS SOCKET (FRENCH) CHILD PROTECTION WITH COVER
2270 448 02XX	TEKLİ USB ŞARJ PRİZİ	USB CHARGE SOCKET
2270 449 02XX	İKİLİ USB ŞARJ PRİZİ	USB CHARGE TWO SOCKET
İLETİŞİM GRUBU		COMMUNICATIONS GROUP
2270 125 01XX	TELEFON PRİZİ 1*RJ12 (CAT 3)	TELEPHONE SOCKET 1*RJ12 (CAT 3)
2270 126 01XX	TELEFON PRİZİ 2*RJ12 (CAT 3)	TELEPHONE SOCKET 2*RJ12 (CAT 3)
2270 128 01XX	ETİKETLİ TELEFON DATA PRİZ (KON.SÜZ)	TELEPHONE DATA SOCKET WITH LABEL (WITHOUT CONNECTOR)
2270 135 01XX	DATA PRİZ 1*RJ45 (KONNEKTÖRSÜZ)	DATA SOCKET 1*RJ45 (WITHOUT CONNECTOR)
2270 136 01XX	DATA PRİZ 1*RJ45 (CAT 5E)	DATA SOCKET 1*RJ45 (CAT 5E)
2270 137 01XX	DATA PRİZ 2*RJ45 (KONNEKTÖRSÜZ)	DATA SOCKET 2*RJ45 (WITHOUT CONNECTOR)
2270 138 01XX	DATA PRİZ 2*RJ45 (CAT 5E)	DATA SOCKET 2*RJ45 (CAT 5E)
2270 139 01XX	DATA PRİZ (RJ12 CAT 3+CAT 5 E)	DATA SOCKET (RJ12 CAT 3+CAT 5 E)
2270 140 01XX	DATA PRİZ 1*RJ45 (CAT 6)	DATA SOCKET 1*RJ45 (CAT 6)
2270 141 01XX	DATA PRİZ 2*RJ45 (CAT 6)	DATA SOCKET 2*RJ45 (CAT 6)
2270 455 01XX	DATA PRİZ 1*USB	DATA SOCKET 1* USB
2270 456 01XX	DATA PRİZ 2*USB	DATA SOCKET 2* USB
2270 457 01XX	DATA PRİZ 1*HDMI	DATA SOCKET 1*HDMI
2270 458 01XX	DATA PRİZ 2*HDMI	DATA SOCKET 2*HDMI
459 01XX	DATA PRİZ 1*USB / 1*HDMI	DATA SOCKET 1*USB / 1*HDMI
2270 460 01XX	VGA PRİZ	VGA SOCKET
2270 121 02XX	KÖR KAPAK	BLIND COVER
TV / SAT GRUBU		TV / SAT GROUP
2270 156 02XX	TV / SAT PRİZİ (GEÇİŞLİ) 4DB/F KON.	TV / SAT SOCKET (THROUGH) 4DB/F CON.
2270 157 02XX	TV / SAT PRİZİ (SONLU)	TV / SAT SOCKET (DEAD-END)
2270 166 01XX	SAT PRİZİ (GEÇİŞLİ) 4DB/F KON.	SAT SOCKET (THROUGH)
2270 167 01XX	SAT PRİZİ (SONLU)	SAT SOCKET (DEAD-END)
2270 170 01XX	TV PRİZİ (GEÇİŞLİ) 11 DB	TV SOCKET (THROUGH) 11 DB
2270 171 01XX	TV PRİZİ (SONLU)	TV SOCKET (DEAD-END)
2270 172 01XX	TV PRİZİ F DIŞI	TV SOCKET F FEMALE
SIVA ÜSTÜ KASA		SURFACE BOX
2100 000 11XX	SIVA ÜSTÜ KASA	SURFACE MOUNTED BOX

Candela

SERİSİ
SERIES



Şık çözümler...

Zarif ve ince çizgileriyle konforunuzu artıran, şıklığınızı tamamlayan çözümler geliştirdik.



Metallic

METALİK • METALLIC



Elegant solutions ...

We have developed solutions that enhance comfort with elegant and subtle lines, complementing your elegance...



Candela

SERİSİ
SERIES



Mekanınızla uyumlu...

Dekorasyonunuzu bütünleyen şık görünümü tamamlayan ustaca dokunuşlar.

Compatible with your place...

The masterful touches that complement the elegant look that completes your decoration.



Will color your children's room

Shifting different from day to night...



Gece
Night

Gündüz
Day



Genç ve çocuk odalarını renklendirecek,

Gece farklı gündüz farklı değişen desenli...



2127 510 01 XX
TRAFFIC



2127 510 02 XX
TRAIN



2127 514 01 XX
CARETTA



2127 516 01 XX
BALLOON



2127 518 01 XX
DOLPHIN



2127 520 01 XX
SEA HORSE



2127 522 01 XX
LOVE



2127 524 01 XX
COW



2127 526 01 XX
CARUSEL



2127 528 01 XX
DIVER

Candelä

ÇERÇEVELER
FRAMES

ÇERÇEVELER

Tekliden altılıya kadar çoklu anahtar ihtiyaçlarınızın çözümü...

FRAMES

Multi-key solution for your needs from single up to six...



RENK SEÇENEKLERİ COLORS OPTIONS

NATUREL • NATURAL



XX : 01 Beyaz • White



XX : 02 Krem • Ivory

METALİK • METALLIC



XX : 80
Antik altın • Antique gold



XX : 82
İnoks • Inox



XX : 83
Titanyum • Titanium



XX : 84
Siyah • Black



XX : 95
Füme • Smoked

AHŞAP DESEN • WOOD PATTERN



XX : 56 Kiraz • Cherry



XX : 57 Ceviz • Walnuts



XX : 58 Meşe • Oak

CANDELA KIDS



XX : 01 Beyaz • White



XX : 11 Pembe • Pink



XX : 12 Mavi • Blue

YATAY ÇERÇEVELER • HORIZONTAL FRAMES

2125 800 11 XX
1'li Çerçeve • 1 Gang frame



2125 800 12 XX
2'li Çerçeve • 2 Gang frame



2125 800 13 XX
3'lü Çerçeve • 3 Gang frame

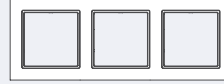

2125 800 14 XX
4'lü Çerçeve • 4 Gang frame



2125 800 15 XX
5'li Çerçeve • 5 Gang frame



2125 800 16 XX
6'li Çerçeve • 6 Gang frame

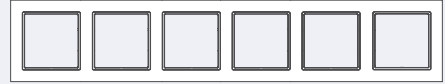

DİKEY ÇERÇEVELER • VERTICAL FRAMES

2125 800 22 XX
2'li Çerçeve
2 Gang frame



2125 800 23 XX
3'lü Çerçeve
3 Gang frame



2125 800 24 XX
4'lü Çerçeve
4 Gang frame

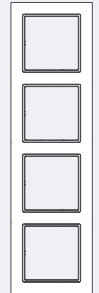

2125 800 25 XX
5'li Çerçeve
5 Gang frame



2125 800 26 XX
6'li Çerçeve
6 Gang frame



Bu ürün kodlarında XX çerçeve rengini belirtmektedir.
XX specify frame color for these products.

Candelä

TEKNİK BİLGİLER
TECHNICAL FEATURES

BOYUTLAR • DIMENSIONS

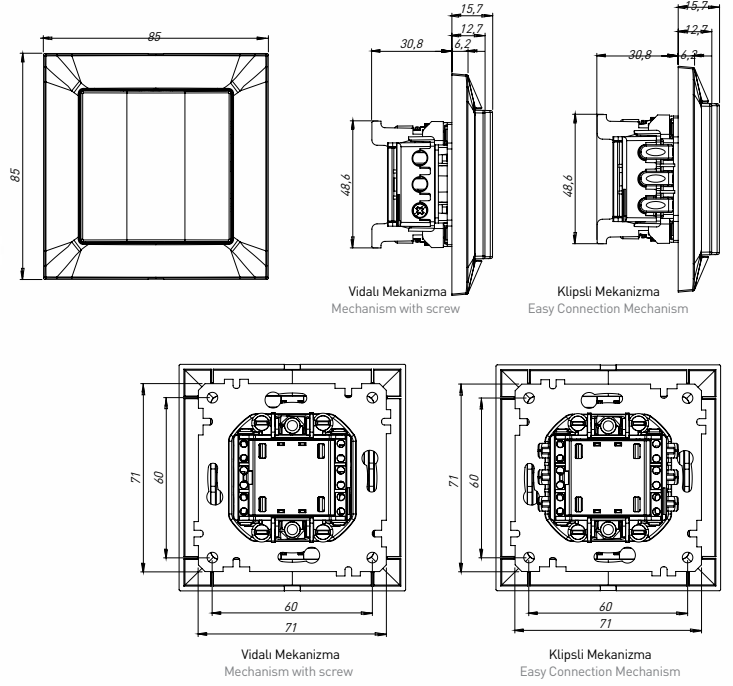

MEKANİZMA + TUŞ ÜRÜN LİSTESİ • MECHANISM + PLATE PRODUCT LIST

Kod / Code	Ürün Tanımı	Description
ANAHTAR GRUBU VİDALI		
SWITCH GROUP (WITH SCREW)		
2100 401 02XX	ANAHTAR (VİDALI)	ONE GANG ONE WAY SWITCH
2100 402 02XX	KOMÜTATÖR (VİDALI)	TWO GANG ONE WAY SWITCH
2100 403 02XX	VAVİEN(İKİ YOLLU ANAHTAR) (VİDALI)	ONE GANG TWO WAY SWITCH (VA-ET-VIENT)
2100 404 02XX	KOMÜTATÖR VAVİEN (VİDALI)	TWO GANG TWO WAY SWITCH (COMMUTATOR VEAVIEN)
2100 405 02XX	ÇİFT KUTUPLU ANAHTAR (VİDALI)	DOUBLE POLE SWITCH
2100 406 02XX	JALUZİ ANAHTARI-YAYLI (VİDALI)	BLIND SWITCH (CONTROL SWITCH)
2100 407 02XX	ÇAĞIRMA (LİGH) (VİDALI)	ONE GANG ONE WAY SWITCH (LIGHT) (PUSH Plate)
2100 407 02XXK	KAPI OTOMATIĞI ANAHTARI (VİDALI)	DOOR SWITCH
2100 407 02XXZ	ZİL ANAHTARI (VİDALI)	BELL SWITCH
2100 408 02XX	DEVIATÖR (ARA VAVİEN) (VİDALI)	ONE GANG INTERMEDIATE SWITCH
2100 409 02XX	ÜÇLÜ ANAHTAR (VİDALI)	THREE GANG ONE WAY SWITCH
2100 411 02XX	ŞOFBEN ANAHTARI (VİDALI)	HEATER SWITCH
2100 415 02XX	IŞIKLI ANAHTAR (220V) (VİDALI)	ILLUMINATED ONE (220V)GANG ONE WAY SWITCH
2100 416 02XX	IŞIKLI VAVİEN (220V) (VİDALI)	ILLUMINATED ONE GANG TWO WAY
2100 417 02XX	IŞIKLI ÇAĞIRMA(220V) (VİDALI)	ILLUMINATED ONE GANG ONE WAY (PUSH Plate) SWITCH)
2100 418 02XX	IŞIKLI ETİKETLİ ANAHTAR (220V) (VİDALI)	ILLUMINATED 1 G 1 W SWITCH WITH LABEL
2100 419 02XX	IŞIKLI ETİKETLİ ÇAĞIRMA (220V) (VİDALI)	ILLUMINATED 1 G 1 W SWITCH WITH LABEL (PUSH Plate)
2100 422 02XX	IŞIKLI ZİL ÇAĞIRMA (12V) (VİDALI)	ILLUMINATED ONE GANG ONE WAY SWITCH (PUSH Plate)
2100 426 02XX	IŞIKLI KOMÜTATÖR (VİDALI)	ILLUMINATED TWO GANG ONE WAY SWITCH (220V)
ANAHTAR GRUBU KLİPSLİ		
SWITCH GROUP EASY CONNECTION		
2100 401 01XX	ANAHTAR (KLİPSLİ)	ONE GANG ONE WAY SWITCH
2100 402 01XX	KOMÜTATÖR (KLİPSLİ)	TWO GANG ONE WAY SWITCH
2100 403 01XX	VAVİEN(İKİ YOLLU ANAHTAR) (KLİPSLİ)	ONE GANG TWO WAY SWITCH (VA-ET-VIENT)
2100 404 01XX	KOMÜTATÖR VAVİEN (KLİPSLİ)	TWO GANG TWO WAY SWITCH (COMMUTATOR VEAVIEN)
2100 405 01XX	ÇİFT KUTUPLU ANAHTAR (KLİPSLİ)	DOUBLE POLE SWITCH
2100 406 01XX	JALUZİ ANAHTARI-YAYLI (KLİPSLİ)	BLIND SWITCH (CONTROL SWITCH)
2100 407 01XX	ÇAĞIRMA (LİGH) (KLİPSLİ)	ONE GANG ONE WAY SWITCH (LIGHT) (PUSH Plate)
2100 407 01XXK	KAPI OTOMATIĞI ANAHTARI (KLİPSLİ)	DOOR SWITCH
2100 407 01XXZ	ZİL ANAHTARI (KLİPSLİ)	BELL SWITCH
2100 408 01XX	DEVIATÖR (ARA VAVİEN) (KLİPSLİ)	ONE GANG INTERMEDIATE SWITCH
2100 409 01XX	ÜÇLÜ ANAHTAR (KLİPSLİ)	THREE GANG ONE WAY SWITCH
2100 415 01XX	IŞIKLI ANAHTAR (220V) (KLİPSLİ)	ILLUMINATED ONE (220V)GANG ONE WAY SWITCH
2100 416 01XX	IŞIKLI VAVİEN (220V) (KLİPSLİ)	ILLUMINATED ONE GANG TWO WAY
2100 417 01XX	IŞIKLI ÇAĞIRMA(220V) (KLİPSLİ)	ILLUMINATED ONE GANG ONE WAY (PUSH Plate) SWITCH)
2100 418 01XX	IŞIKLI ETİKETLİ ANAHTAR (220V) (KLİPSLİ)	ILLUMINATED 1 G 1 W SWITCH WITH LABEL
2100 419 01XX	IŞIKLI ETİKETLİ ÇAĞIRMA (220V) (KLİPSLİ)	ILLUMINATED 1 G 1 W SWITCH WITH LABEL (PUSH Plate)
2100 422 01XX	IŞIKLI ZİL ÇAĞIRMA (12V) (KLİPSLİ)	ILLUMINATED ONE GANG ONE WAY SWITCH (PUSH Plate)
2100 426 01XX	IŞIKLI KOMÜTATÖR (KLİPSLİ)	ILLUMINATED TWO GANG ONE WAY SWITCH (220V)

MEKANİZMA + TUŞ ÜRÜN LİSTESİ • MECHANISM + PLATE PRODUCT LIST

Kod / Code	Ürün Tanımı	Description
DİMMER GRUBU		DIMMER GROUP
2100 440 02XX	İŞIKLI DİMMER (600 W)	RL ILLUMINATED DIMMER (600 W)
2100 443 02XX	İŞIKLI DİMMER CE'Li (600 W) FİLTRELİ	RL ILLUMINATED DIMMER (600 W CE)
2100 444 02XX	İŞIKLI DİMMER (1000 W)	RL ILLUMINATED DIMMER (1000 W)
2100 445 02XX	RLC DİMMER (10-300W)	RLC DIMMER (10-300W)
ELEKTRONİK GRUBU		ELECTRONIC GROUP
2100 450 02XX	ENERGY SAVER GECİKMESİZ İŞIKLI	ENERGY SAVER ILLUMINATED
2100 452 02XX	ENERGY SAVER GECİKMELİ İŞIKLI	ENERGY SAVER WITH DELAY
2100 470 02XX	MÜZİK YAYIN ANAHTARI	AUDIO SWITCH
2100 480 02XX	HOPARLÖR PRİZİ	SPEAKER SOCKET
2100 485 02XX	UYARI ZİLİ	WARNING SWITCH
2100 495 02XX	HAREKET SENSÖRÜ	MOVEMENT SENSOR
PRİZ GRUBU		SOCKET GROUP
2100 600 02XX	TOPRAKLI PRİZ	EARTHED SOCKET OUTLET
2100 601 02XX	TOPRAKSIZ PRİZ	SOCKET OUTLET NON- EARTHED
2100 605 02XX	TOPRAKLI PRİZ (ÇOCUK KORUMALI)	EARTHED SOCKET WITH CHILD PROTECTION
2100 606 02XX	TOPRAKSIZ PRİZ (ÇOCUK KORUMALI)	SOCKET OUTLET WITH CHILD PROTECTION NON EARTHED
2100 610 02XX	KAPAKLI TOPRAKLI PRİZ	EARTHED SOCKET WITH COVER
2100 611 02XX	KAPAKLI TOPRAKLI PRİZ (ÇOCUK KORUMALI)	EARTHED SOCKET WITH CHILD PROTECTION COVER
2100 615 02XX	UPS (FRANSIZ) PRİZİ	UPS (FRENCH) SOCKET (EARTHED SOCKET WITH PIN)
2100 616 02XX	UPS (FRANSIZ) PRİZİ (ÇOCUK KORUMALI)	UPS (FRENCH) SOCKET (CHILD PROTECTION)
2100 617 02XX	UPS KAPAKLI(FRANSIZ) PRİZİ	UPS SOCKET (FRENCH) WITH COVER
2100 618 02XX	UPS (FRANSIZ)KAP. TOPRAKLI PRİZ (ÇOC.KRM)	UPS SOCKET (FRENCH) WITH COVER (CHILD PROTECTION)
2100 200 02XX	İKİLİ TOPRAKLI PRİZ (PORSELEN)	DOUBLE SOCKET EARTHED PORCELAIN
2100 201 02XX	İKİLİ TOPRAKSIZ PRİZ (PORSELEN)	DOUBLE SOCKET (NON EARTHED) PORCELAIN
2100 202 02XX	İKİLİ TOPRAKLI PRİZ	DOUBLE SOCKET EARTHED
2100 203 02XX	İKİLİ TOPRAKSIZ PRİZ	DOUBLE SOCKET (NON EARTHED)
2100 215 02XX	İKİLİ UPS PRİZ	DOUBLE SOCKET WITH UPS (FRENCH)
2100 448 02XX	TEKLİ USB ŞARJ PRİZİ	USB CHARGE SOCKET
2100 449 02XX	İKİLİ USB ŞARJ PRİZİ	USB CHARGE TWO SOCKET
İLETİŞİM GRUBU		COMMUNICATIONS GROUP
2100 125 01XX	TELEFON PRİZİ 1*RJ12 (CAT 3)	TELEPHONE SOCKET 1*RJ12 (CAT 3)
2100 126 01XX	TELEFON PRİZİ 2*RJ12 (CAT 3)	TELEPHONE SOCKET 2*RJ12 (CAT 3)
2100 128 01XX	ETİKETLİ TELEFON DATA PRİZ (KON.SÜZ)	TELEPHONE DATA SOCKET WITH LABEL (WITHOUT CONNECTOR)
2100 135 01XX	DATA PRİZ 1*RJ45 (KONNEKTÖRSÜZ)	DATA SOCKET 1*RJ45 (WITHOUT CONNECTOR)
2100 136 01XX	DATA PRİZ 1*RJ45 (CAT 5E)	DATA SOCKET 1*RJ45 (CAT 5E)
2100 137 01XX	DATA PRİZ 2*RJ45 (KONNEKTÖRSÜZ)	DATA SOCKET 2*RJ45 (WITHOUT CONNECTOR)
2100 138 01XX	DATA PRİZ 2*RJ45 (CAT 5E)	DATA SOCKET 2*RJ45 (CAT 5E)
2100 139 01XX	DATA PRİZ (RJ12 CAT 3+CAT 5 E)	DATA SOCKET (RJ12 CAT 3+CAT 5 E)
2100 140 01XX	DATA PRİZ 1*RJ45 (CAT 6)	DATA SOCKET 1*RJ45 (CAT 6)
2100 141 01XX	DATA PRİZ 2*RJ45 (CAT 6)	DATA SOCKET 2*RJ45 (CAT 6)
2100 455 01XX	DATA PRİZ 1*USB	DATA SOCKET 1* USB
2100 456 01XX	DATA PRİZ 2*USB	DATA SOCKET 2* USB
2100 457 01XX	DATA PRİZ 1*HDMI	DATA SOCKET 1*HDMI
2100 458 01XX	DATA PRİZ 2*HDMI	DATA SOCKET 2*HDMI
2100 459 01XX	DATA PRİZ 1*USB / 1*HDMI	DATA SOCKET 1*USB / 1*HDMI
2100 460 01XX	VGA PRİZ	VGA SOCKET
2100 121 02XX	KÖR KAPAK	BLIND COVER
TV / SAT GRUBU		TV / SAT GROUP
2100 156 02XX	TV / SAT PRİZİ (GEÇİŞLİ) 4DB/F KON.	TV / SAT SOCKET (THROUGH) 4DB/F CON.
2100 157 02XX	TV / SAT PRİZİ (SONLU)	TV / SAT SOCKET (DEAD-END)
2100 166 01XX	SAT PRİZİ (GEÇİŞLİ) 4DB/F KON.	SAT SOCKET (THROUGH)
2100 167 01XX	SAT PRİZİ (SONLU)	SAT SOCKET (DEAD-END)
2100 170 01XX	TV PRİZİ (GEÇİŞLİ) 11 DB	TV SOCKET (THROUGH) 11 DB
2100 171 01XX	TV PRİZİ (SONLU)	TV SOCKET (DEAD-END)
2100 172 01XX	TV PRİZİ F DIŞI	TV SOCKET F FEMALE
2190 500 02XX	İNGİLİZ TİP ANAHTAR PRİZ	
SIVA ÜSTÜ KASA		SURFACE BOX
2100 000 11XX	SIVA ÜSTÜ KASA	SURFACE MOUNTED BOX

Darİa

SERİSİ
SERIES



Mutlu anlarınıza şahitlik edecek...

Kendi dünyanızı yaratın, bulunduğunuz mekandan keyif alın diye ürettik..



Metallic

METALİK • METALLIC



Witness to your happy moments ...

We create for you to create your own world,
to enjoy your places...



Daria
SERİSİ
SERIES



Doğallığı zarafetle harmanladık ...

Farklı tarzları harmanlayan bir tasarım anlayışı odanızda hayat bulsun...

We blended the naturalness and elegance ...

An understanding of design that blends different styles energise in your room...



ÇERÇEVELER FRAMES



RENK SEÇENEKLERİ COLORS OPTIONS

NATUREL • NATURAL



XX : 01 Beyaz • White



XX : 02 Krem • Ivory

METALİK • METALLIC



XX : 80
Antik altın • Antique gold



XX : 82
İnoks • Inox



XX : 83
Titanyum • Titanium



XX : 84
Siyah • Black



XX : 95
Füme • Smoked

AHŞAP DESEN • WOOD PATTERN



XX : 56 Kiraz • Cherry



XX : 57 Ceviz • Walnuts



XX : 58 Meşe • Oak



YATAY ÇERÇEVELER • HORIZONTAL FRAMES

2120 800 11 XX
1'li Çerçeve • 1 Gang frame



2120 800 12 XX
2'li Çerçeve • 2 Gang frame



2120 800 13 XX
3'lü Çerçeve • 3 Gang frame



2120 800 14 XX
4'lü Çerçeve • 4 Gang frame



2120 800 15 XX
5'li Çerçeve • 5 Gang frame



DİKEY ÇERÇEVELER • VERTICAL FRAMES

2120 800 22 XX
2'li Çerçeve
2 Gang frame



2120 800 23 XX
3'lü Çerçeve
3 Gang frame



2120 800 24 XX
4'lü Çerçeve
4 Gang frame



2120 800 25 XX
5'li Çerçeve
5 Gang frame

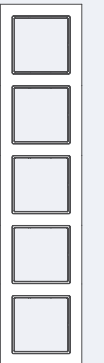

Bu ürün kodlarında XX çerçeve rengini belirtmektedir.
XX specify frame color for these products.

BOYUTLAR • DIMENSIONS

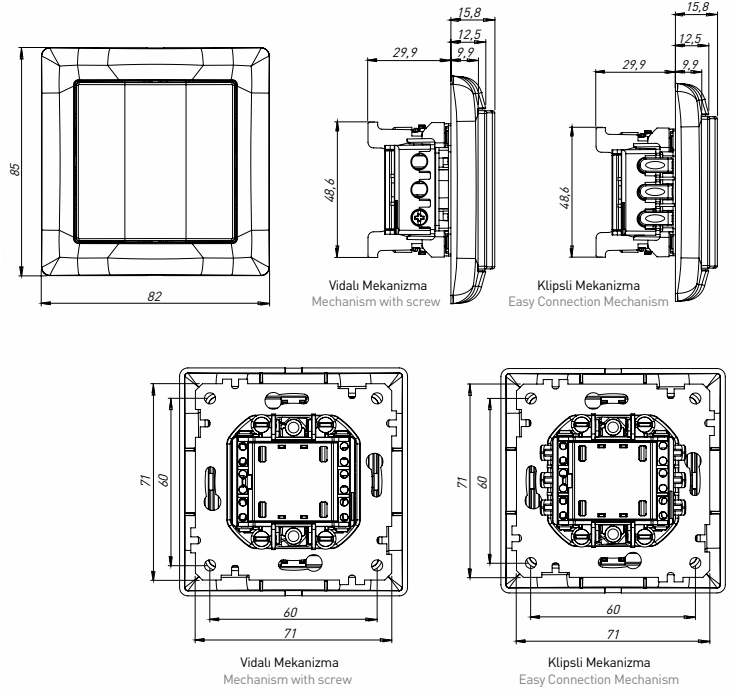

MEKANİZMA + TUŞ ÜRÜN LİSTESİ • MECHANISM + PLATE PRODUCT LIST

Kod / Code	Ürün Tanımı	Description
ANAHTAR GRUBU VİDALI		
SWITCH GROUP (WITH SCREW)		
2100 401 02XX	ANAHTAR (VİDALI)	ONE GANG ONE WAY SWITCH
2100 402 02XX	KOMÜTATÖR (VİDALI)	TWO GANG ONE WAY SWITCH
2100 403 02XX	VAVİEN (İKİ YOLLU ANAHTAR) (VİDALI)	ONE GANG TWO WAY SWITCH (VA-ET-VIENT)
2100 404 02XX	KOMÜTATÖR VAVİEN (VİDALI)	TWO GANG TWO WAY SWITCH (COMMUTATOR VEAVIEN)
2100 405 02XX	ÇİFT KUTUPLU ANAHTAR (VİDALI)	DOUBLE POLE SWITCH
2100 406 02XX	JALUZİ ANAHTARI-YAYLI (VİDALI)	BLIND SWITCH (CONTROL SWITCH)
2100 407 02XX	ÇAĞIRMA (LIGHT) (VİDALI)	ONE GANG ONE WAY SWITCH (LIGHT) (PUSH Plate)
2100 407 02XXK	KAPI OTOMATIĞI ANAHTARI (VİDALI)	DOOR SWITCH
2100 407 02XXZ	ZİL ANAHTARI (VİDALI)	BELL SWITCH
2100 408 02XX	DEVİATÖR (ARA VAVİEN) (VİDALI)	ONE GANG INTERMEDIATE SWITCH
2100 409 02XX	ÜÇLÜ ANAHTAR (VİDALI)	THREE GANG ONE WAY SWITCH
2100 411 02XX	ŞOFBEN ANAHTARI (VİDALI)	HEATER SWITCH
2100 415 02XX	IŞIKLI ANAHTAR (220V) (VİDALI)	ILLUMINATED ONE (220V)GANG ONE WAY SWITCH
2100 416 02XX	IŞIKLI VAVİEN (220V) (VİDALI)	ILLUMINATED ONE GANG TWO WAY
2100 417 02XX	IŞIKLI ÇAĞIRMA(220V) (VİDALI)	ILLUMINATED ONE GANG ONE WAY (PUSH Plate) SWITCH)
2100 418 02XX	IŞIKLI ETİKETLİ ANAHTAR (220V) (VİDALI)	ILLUMINATED 1 G 1 W SWITCH WITH LABEL
2100 419 02XX	IŞIKLI ETİKETLİ ÇAĞIRMA (220V) (VİDALI)	ILLUMINATED 1 G 1 W SWITCH WITH LABEL (PUSH Plate)
2100 422 02XX	IŞIKLI ZİL ÇAĞIRMA (12V) (VİDALI)	ILLUMINATED ONE GANG ONE WAY SWITCH (PUSH Plate)
2100 426 02XX	IŞIKLI KOMÜTATÖR (VİDALI)	ILLUMINATED TWO GANG ONE WAY SWITCH (220V)

ANAHTAR GRUBU KLİPSLİ		
SWITCH GROUP EASY CONNECTION		
2100 401 01XX	ANAHTAR (KLİPSLİ)	ONE GANG ONE WAY SWITCH
2100 402 01XX	KOMÜTATÖR (KLİPSLİ)	TWO GANG ONE WAY SWITCH
2100 403 01XX	VAVİEN (İKİ YOLLU ANAHTAR) (KLİPSLİ)	ONE GANG TWO WAY SWITCH (VA-ET-VIENT)
2100 404 01XX	KOMÜTATÖR VAVİEN (KLİPSLİ)	TWO GANG TWO WAY SWITCH (COMMUTATOR VEAVIEN)
2100 405 01XX	ÇİFT KUTUPLU ANAHTAR (KLİPSLİ)	DOUBLE POLE SWITCH
2100 406 01XX	JALUZİ ANAHTARI-YAYLI (KLİPSLİ)	BLIND SWITCH (CONTROL SWITCH)
2100 407 01XX	ÇAĞIRMA (LIGHT) (KLİPSLİ)	ONE GANG ONE WAY SWITCH (LIGHT) (PUSH Plate)
2100 407 01XXK	KAPI OTOMATIĞI ANAHTARI (KLİPSLİ)	DOOR SWITCH
2100 407 01XXZ	ZİL ANAHTARI (KLİPSLİ)	BELL SWITCH
2100 408 01XX	DEVİATÖR (ARA VAVİEN) (KLİPSLİ)	ONE GANG INTERMEDIATE SWITCH
2100 409 01XX	ÜÇLÜ ANAHTAR (KLİPSLİ)	THREE GANG ONE WAY SWITCH
2100 415 01XX	IŞIKLI ANAHTAR (220V) (KLİPSLİ)	ILLUMINATED ONE (220V)GANG ONE WAY SWITCH
2100 416 01XX	IŞIKLI VAVİEN (220V) (KLİPSLİ)	ILLUMINATED ONE GANG TWO WAY
2100 417 01XX	IŞIKLI ÇAĞIRMA(220V) (KLİPSLİ)	ILLUMINATED ONE GANG ONE WAY (PUSH Plate) SWITCH)
2100 418 01XX	IŞIKLI ETİKETLİ ANAHTAR (220V) (KLİPSLİ)	ILLUMINATED 1 G 1 W SWITCH WITH LABEL
2100 419 01XX	IŞIKLI ETİKETLİ ÇAĞIRMA (220V) (KLİPSLİ)	ILLUMINATED 1 G 1 W SWITCH WITH LABEL (PUSH Plate)
2100 422 01XX	IŞIKLI ZİL ÇAĞIRMA (12V) (KLİPSLİ)	ILLUMINATED ONE GANG ONE WAY SWITCH (PUSH Plate)
2100 426 01XX	IŞIKLI KOMÜTATÖR (KLİPSLİ)	ILLUMINATED TWO GANG ONE WAY SWITCH (220V)

MEKANİZMA + TUŞ ÜRÜN LİSTESİ • MECHANISM + PLATE PRODUCT LIST

Kod / Code	Ürün Tanımı	Description
DİMMER GRUBU		DIMMER GROUP
2100 440 02XX	IŞIKLI DİMMER (600 W)	RL ILLUMINATED DIMMER (600 W)
2100 443 02XX	IŞIKLI DİMMER CE'Lİ (600 W) FİLTRELİ	RL ILLUMINATED DIMMER (600 W CE)
2100 444 02XX	IŞIKLI DİMMER (1000 W)	RL ILLUMINATED DIMMER (1000 W)
2100 445 02XX	RLC DİMMER (10-300W)	RLC DIMMER (10-300W)
ELEKTRONİK GRUBU		ELECTRONIC GROUP
2100 450 02XX	ENERGY SAVER GECİKMESİZ IŞIKLI	ENERGY SAVER ILLUMINATED
2100 452 02XX	ENERGY SAVER GECİKMELİ IŞIKLI	ENERGY SAVER WITH DELAY
2100 470 02XX	MÜZİK YAYIN ANAHTARI	AUDIO SWITCH
2100 480 02XX	HOPARLÖR PRİZİ	SPEAKER SOCKET
2100 485 02XX	UYARI ZİLİ	WARNING SWITCH
2100 495 02XX	HAREKET SENSÖRÜ	MOVEMENT SENSOR
PRİZ GRUBU		SOCKET GROUP
2100 600 02XX	TOPRAKLI PRİZ	EARTHED SOCKET OUTLET
2100 601 02XX	TOPRAKSIZ PRİZ	SOCKET OUTLET NON- EARTHED
2100 605 02XX	TOPRAKLI PRİZ (ÇOCUK KORUMALI)	EARTHED SOCKET WITH CHILD PROTECTION
2100 606 02XX	TOPRAKSIZ PRİZ (ÇOCUK KORUMALI)	SOCKET OUTLET WITH CHILD PROTECTION NON EARTHED
2100 610 02XX	KAPAKLI TOPRAKLI PRİZ	EARTHED SOCKET WITH COVER
2100 611 02XX	KAPAKLI TOPRAKLI PRİZ (ÇOCUK KORUMALI)	EARTHED SOCKET WITH CHILD PROTECTION COVER
2100 615 02XX	UPS (FRANSIZ) PRİZİ	UPS (FRENCH) SOCKET (EARTHED SOCKET WITH PIN)
2100 616 02XX	UPS (FRANSIZ) PRİZİ (ÇOCUK KORUMALI)	UPS (FRENCH) SOCKET (CHILD PROTECTION)
2100 617 02XX	UPS KAPAKLI(FRANSIZ) PRİZİ	UPS SOCKET (FRENCH) WITH COVER
2100 618 02XX	UPS (FRANSIZ)KAP. TOPRAKLI PRİZ (ÇOC.KRM)	UPS SOCKET (FRENCH) WITH COVER (CHILD PROTECTION)
2100 200 02XX	İKİLİ TOPRAKLI PRİZ (PORSELEN)	DOUBLE SOCKET EARTHED PORCELAIN
2100 201 02XX	İKİLİ TOPRAKSIZ PRİZ (PORSELEN)	DOUBLE SOCKET (NON EARTHED) PORCELAIN
2100 202 02XX	İKİLİ TOPRAKLI PRİZ	DOUBLE SOCKET EARTHED
2100 203 02XX	İKİLİ TOPRAKSIZ PRİZ	DOUBLE SOCKET (NON EARTHED)
2100 215 02XX	İKİLİ UPS PRİZ	DOUBLE SOCKET WITH UPS (FRENCH)
2100 448 02XX	TEKLİ USB ŞARJ PRİZİ	USB CHARGE SOCKET
2100 449 02XX	İKİLİ USB ŞARJ PRİZİ	USB CHARGE TWO SOCKET
İLETİŞİM GRUBU		COMMUNICATIONS GROUP
2100 125 01XX	TELEFON PRİZİ 1*RJ12 (CAT 3)	TELEPHONE SOCKET 1*RJ12 (CAT 3)
2100 126 01XX	TELEFON PRİZİ 2*RJ12 (CAT 3)	TELEPHONE SOCKET 2*RJ12 (CAT 3)
2100 128 01XX	ETİKETLİ TELEFON DATA PRİZ (KON.SÜZ)	TELEPHONE DATA SOCKET WITH LABEL (WITHOUT CONNECTOR)
2100 135 01XX	DATA PRİZ 1*RJ45 (KONNEKTÖRSÜZ)	DATA SOCKET 1*RJ45 (WITHOUT CONNECTOR)
2100 136 01XX	DATA PRİZ 1*RJ45 (CAT 5E)	DATA SOCKET 1*RJ45 (CAT 5E)
2100 137 01XX	DATA PRİZ 2*RJ45 (KONNEKTÖRSÜZ)	DATA SOCKET 2*RJ45 (WITHOUT CONNECTOR)
2100 138 01XX	DATA PRİZ 2*RJ45 (CAT 5E)	DATA SOCKET 2*RJ45 (CAT 5E)
2100 139 01XX	DATA PRİZ (RJ12 CAT 3+CAT 5 E)	DATA SOCKET (RJ12 CAT 3+CAT 5 E)
2100 140 01XX	DATA PRİZ 1*RJ45 (CAT 6)	DATA SOCKET 1*RJ45 (CAT 6)
2100 141 01XX	DATA PRİZ 2*RJ45 (CAT 6)	DATA SOCKET 2*RJ45 (CAT 6)
2100 455 01XX	DATA PRİZ 1*USB	DATA SOCKET 1* USB
2100 456 01XX	DATA PRİZ 2*USB	DATA SOCKET 2* USB
2100 457 01XX	DATA PRİZ 1*HDMI	DATA SOCKET 1*HDMI
2100 458 01XX	DATA PRİZ 2*HDMI	DATA SOCKET 2*HDMI
2100 459 01XX	DATA PRİZ 1*USB / 1*HDMI	DATA SOCKET 1*USB / 1*HDMI
2100 460 01XX	VGA PRİZ	VGA SOCKET
2100 121 02XX	KÖR KAPAK	BLIND COVER
TV / SAT GRUBU		TV / SAT GROUP
2100 156 02XX	TV / SAT PRİZİ (GEÇİŞLİ) 4DB/F KON.	TV / SAT SOCKET (THROUGH) 4DB/F CON.
2100 157 02XX	TV / SAT PRİZİ (SONLU)	TV / SAT SOCKET (DEAD-END)
2100 166 01XX	SAT PRİZİ (GEÇİŞLİ) 4DB/F KON.	SAT SOCKET (THROUGH)
2100 167 01XX	SAT PRİZİ (SONLU)	SAT SOCKET (DEAD-END)
2100 170 01XX	TV PRİZİ (GEÇİŞLİ) 11 DB	TV SOCKET (THROUGH) 11 DB
2100 171 01XX	TV PRİZİ (SONLU)	TV SOCKET (DEAD-END)
2100 172 01XX	TV PRİZİ F DIŞI	TV SOCKET F FEMALE
SIVA ÜSTÜ KASA		SURFACE BOX
2100 000 11XX	SIVA ÜSTÜ KASA	SURFACE MOUNTED BOX

Nemliyer

SERİSİ
SERIES



Islak mekanlar için güvenliđi artırılmıř IP44 koruma sınıfında.
Naturel ve ahřap renk seenekleriyle sıva st anahtar
uygulamalarının vazgeilmez rnleri.



SIVA ÜSTÜ • SURFACE

For wet places
security-enhanced IP44
protection class.
Indispensable products
for surface switch appli-
cations with natural and
wood color choices...



Nemliyer

TEKNİK BİLGİLER
TECHNICAL FEATURES

IP44

BOYUTLAR • DIMENSIONS

Tuşlu ürün ölçüleri • Plate product dimensions

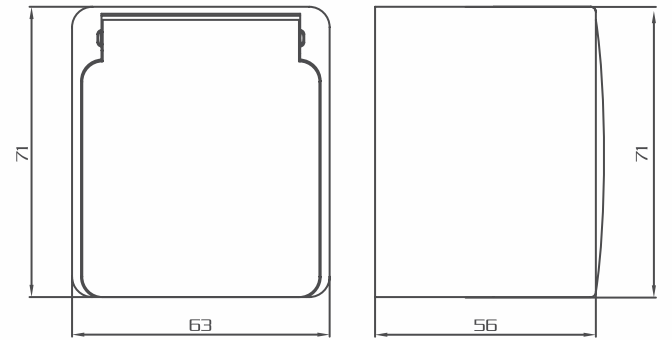
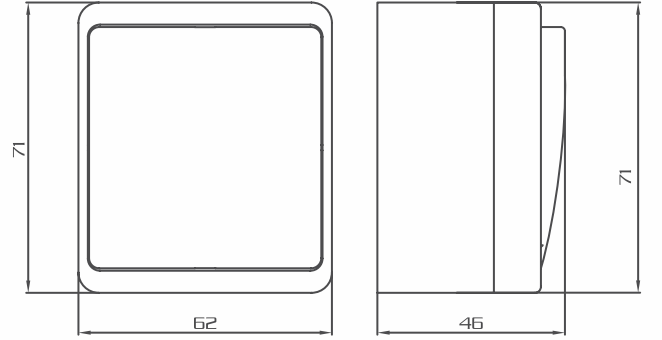

Soketli ürün ölçüleri • Socket product dimensions

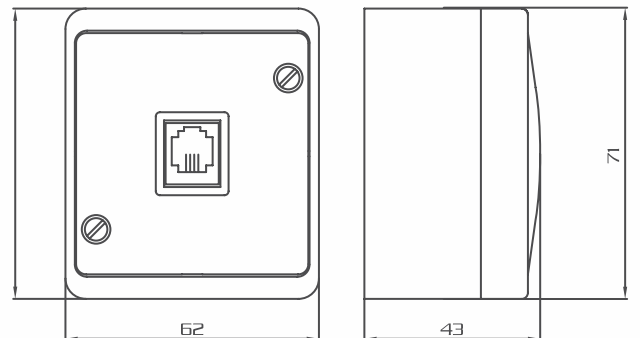

ÜRÜN LİSTESİ • PRODUCT LIST

Kod / Code	Ürün Tanımı	Description
2150 001 01XX	ANAHTAR	ONE GANG ONE WAY SWITCH
2150 002 01XX	KOMİTATÖR	TWO GANG ONE WAY SWITCH
2150 003 01XX	VAVİEN	ONE GANG TWO WAY SWITCH (VEAVIEN)
2150 005 01XX	ÇİFT KUTUPLU ANAHTAR	DOUBLE POLE SWITCH
2150 007 01XX	LİGH (ÇAĞIRMA)	ONE GANG ONE WAY CONTROL SWITCH
2150 008 01XX	DEVİATÖR (ARA VAVİEN)	ONE GANG INTERMEDIATE SWITCH
2150 110 02XX	KAPAKLI TOPRAKLI PRİZ	EARTHED SOCKET WITH COVER
2150 115 02XX	KAPAKLI UPS (FRANSIZ) PRİZ	UPS (FRENCH) SOCKET WITH COVER
2150 125 02XX	TELEFON PRİZİ 1*RJ12 (Cat3)	TELEPHONE SOCKET 1*RJ12 (Cat3)
2150 136 01XX	DATA PRİZİ 1*RJ45 (Cat5e)	DATA SOCKET 1*RJ45 (Cat5e)
2150 166 02XX	SAT PRİZİ (GEÇİŞLİ)	SAT SOCKET (THROUGH)
2150 167 02XX	SAT PRİZİ (SONLU)	SAT SOCKET (DEAD-END)
2150 170 02XX	TV PRİZİ (GEÇİŞLİ)	TV SOCKET (THROUGH)
2150 171 02XX	TV PRİZİ (SONLU)	TV SOCKET (DEAD-END)

RENK SEÇENEKLERİ • COLOR OPTIONS



XX : 01 Beyaz • White

XX : 03 Gri • Grey



XX : 40 Açık Kayın • Light Beech

XX : 41 Koyu Ceviz • Dark Walnuts

XX : 43 Merbau

XX : 44 Maun • Mahogany

XX : 44 Armut • Pear

Bron

SERİSİ
SERIES



Sıva üstü uygulamalarda sorunsuz işlevsel çözümler...

Duvarlarda zarif dokunuşların izini sürün.
Hem şık hem işlevsel ürünlerin hazzını yaşayın.

Hassle-free functional solutions in surface switch applications...

Follow the elegant touches on the walls. Enjoy the pleasures of both stylish and functional products.



Bron

TEKNİK BİLGİLER
TECHNICAL FEATURES

BOYUTLAR • DIMENSIONS

Tuşlu ürün ölçüleri • Plate product dimensions

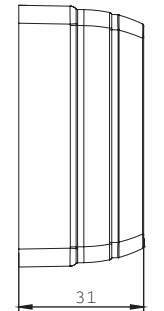
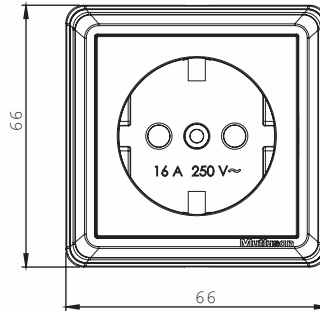
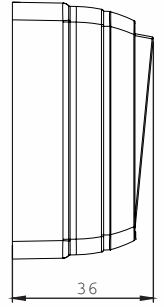
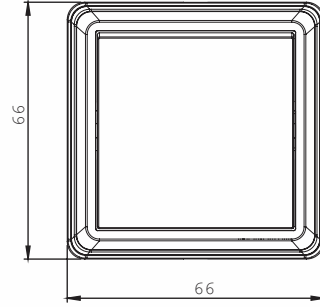

Soketli ürün ölçüleri • Socket product dimensions

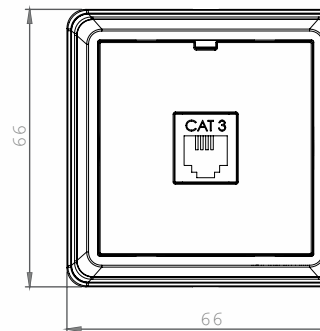

ÜRÜN LİSTESİ • PRODUCT LIST

Kod / Code	Ürün Tanımı	Description
2160 301 02XX	ANAHTAR	ONE GANG ONE WAY SWITCH
2160 302 02XX	KOMİTATÖR	TWO GANG ONE WAY SWITCH
2160 303 02XX	VAVIEN	ONE GANG TWO WAY SWITCH (VEAVIEN)
2160 307 02XX	LIGHT (ÇAĞIRMA)	ONE GANG ONE WAY CONTROL SWITCH
2160 315 02XX	IŞIKLI ANAHTAR (220V)	ILLUMINATED ONE GANG ONE WAY SWITCH (220V)
2160 316 02XX	IŞIKLI VAVIEN (220V)	ILLUMINATED ONE GANG TWO WAY SWITCH (220V) (VEAVIEN)
2160 317 02XX	IŞIKLI LIGHT (ÇAĞIRMA) (220V)	ILLUMINATED ONE GANG ONE WAY CONTROL SWITCH (220V)
2160 326 02XX	IŞIKLI KOMİTATÖR	ILLUMINATED TWO GANG ONE WAY SWITCH (220V)
2160 100 02XX	TOPRAKLI PRİZ	SOCKET OUTLET WITH EARTHED CONTACT (EARTHED SOCKET)
2160 101 02XX	TOPRAKSIZ PRİZ	SOCKET OUTLET
2160 103 02XX	TOPRAKLI PRİZ PORSELEN	SOCKET OUTLET WITH EARTHED CONTACT (EARTHED SOCKET) PORCELAIN
2160 104 02XX	TOPRAKSIZ PRİZ PORSELEN	SOCKET OUTLET PORCELAIN
2160 110 02XX	KAPAKLI TOPRAKLI PRİZ	EARTHED SOCKET WITH COVER
2160 113 02XX	KAPAKLI TOPRAKLI PRİZ PORSELEN	EARTHED SOCKET WITH COVER PORCELAIN
2160 115 02XX	UPS (FRANSIZ) PRİZ	UPS (FRENCH) SOCKET (EARTHED SOCKET WITH PIN)
2160 125 02XX	TELEFON PRİZİ 1*RJ12	TELEPHONE SOCKET 1*RJ12 (CAT3)
2160 136 02XX	DATA PRİZİ 1*RJ45 (CAT5)	DATA SOCKET 1*RJ45 (CAT5)
2160 166 02XX	SAT PRİZİ (GEÇİŞLİ) 4DB/F KONNEKTÖR	SAT SOCKET (THROUGH) 4DB/F CONNECTOR
2160 167 02XX	SAT PRİZİ (SONLU)	SAT SOCKET (DEAD-END)
2160 170 02XX	TV PRİZİ (GEÇİŞLİ)	TV SOCKET (THROUGH)
2160 171 02XX	TV PRİZİ (SONLU)	TV SOCKET (DEAD-END)
2160 200 02XX	İKİLİ TOPRAKLI PRİZ PORSELEN	TWO SOCKET OUTLET WITH EARTHED CONTACT (EARTHED SOCKET) PORCELAIN
2160 201 02XX	İKİLİ TOPRAKSIZ PRİZ PORSELEN	TWO SOCKET OUTLET PORCELAIN
2160 202 02XX	İKİLİ TOPRAKLI PRİZ	TWO SOCKET OUTLET WITH EARTHED CONTACT (EARTHED SOCKET)
2160 203 02XX	İKİLİ TOPRAKSIZ PRİZ	TWO SOCKET OUTLET
2160 215 02XX	İKİLİ UPS (FRANSIZ) PRİZ	UPS DOUBLE (FRENCH) OUTLET

RENK SEÇENEKLERİ • COLOR OPTIONS



XX : 01 Beyaz • White



XX : 02 Krem • Ivory



XX : 57 Ceviz • Walnuts



XX : 58 Meşe • Oak



Ri-tech

Olimpia

Aksesuarlar • Accessories



GRUP PRİZLER
GROUP SOCKETS

Ri-tech
Grup Priz / Group Socket

**Yeni
New**

**Askı Aparatı
Hanging Kit**

**USB Şarj Priz
USB Socket
(5V 2.1A)**

**Kolay Bağlantı
Easy Connection**

ANAHTARLI ÇOCUK KORUMALI KOLAY BAĞLANTILI GRUP PRİZLER

Sadece kolay bağlantı kapağını açarak, kablo bağlantıları yapılabilen (priz kontak modülü kısmı açılmayan), herhangi bir yüzeye sabitlenebilme yada asılabilirerek kullanılabilme özellikleri ile evde , ofiste vb. yerlerde çocuk koruma özelliği ile güvenlik ve konforu bir arada sunuyor. Anahtarın içinde ki mavi ışıkla estetikliğini süslüyor.



Group Sockets

GRUP PRİZLER • GROUP SOCKETS

KEY PROTECTION WITH SWITCH EASY CONNECTED GROUP SOCKETS

Cable connections simply by opening the easy connection cover can be mounted (socket contact module part can not be opened), can be fixed to any surface or can be used with the ability to hang at home, office, etc. offers a combination of safety and comfort with child protection. It embellishes its aesthetics with the blue light inside the key.



Olimpia

GRUP PRİZLER
GROUP SOCKETS



Anahtarlı, anahtarsız, UPS, kablolu, klemensli, ikili, üçlü, dördlü, altılı seçenekleriyle taşınabilir enerji ihtiyaçlarınızı karşılayacak.

Group Sockets

GRUP PRİZLER • GROUP SOCKETS

It will meet your portable energy needs with key / keyless switch, UPS, wired, terminal, two gang, three gang, four gang, six gang options.



Ürün Listesi

Product List

Kod / Code	Ürün Tanımı	Description
001 175 210001 00 00	İKİLİ TOP.LI GRUP PRİZ(Ç.K.)(KLEMENSLİ)	2 GANG EARTHED GROUP SOCKET(CHILD PROTEC.)(W/OUT CABLE)
001 175 210002 02 00	İKİLİ TOP.LI GRUP PRİZ(Ç.K.)(2 MT)	2 GANG EARTHED GROUP SOCKET(CHILD PROTEC.)(2 MT)
001 175 210002 03 00	İKİLİ TOP.LI GRUP PRİZ(Ç.K.)(3 MT)	2 GANG EARTHED GROUP SOCKET(CHILD PROTEC.)(3 MT)
001 175 210002 05 00	İKİLİ TOP.LI GRUP PRİZ(Ç.K.)(5 MT)	2 GANG EARTHED GROUP SOCKET(CHILD PROTEC.)(5 MT)
001 175 220001 00 00	İKİLİ ANAHT. TOP.LI GRUP PRİZ(Ç.K.)(KLEMENSLİ)	2 GANG EARTHED GROUP SOCKET(CHILD PROTEC.)(W/OUT CABLE+SWITCH)
001 175 220002 02 00	İKİLİ ANAHT. TOP.LI GRUP PRİZ(Ç.K.)(2 MT)	2 GANG EARTHED GROUP SOCKET(CHILD PROTEC.)(WITH SWITCH)(2 MT)
001 175 220002 03 00	İKİLİ ANAHT. TOP.LI GRUP PRİZ(Ç.K.)(3 MT)	2 GANG EARTHED GROUP SOCKET(CHILD PROTEC.)(WITH SWITCH)(3 MT)
001 175 220002 05 00	İKİLİ ANAHT. TOP.LI GRUP PRİZ(Ç.K.)(5 MT)	2 GANG EARTHED GROUP SOCKET(CHILD PROTEC.)(WITH SWITCH)(5 MT)
001 175 310001 00 00	ÜÇLÜ TOP.LI GRUP PRİZ(Ç.K.)(KLEMENSLİ)	3 GANG EARTHED GROUP SOCKET(CHILD PROTEC.)(W/OUT CABLE)
001 175 310002 02 00	ÜÇLÜ TOP.LI GRUP PRİZ(Ç.K.)(2 MT)	3 GANG EARTHED GROUP SOCKET(CHILD PROTEC.)(2 MT)
001 175 310002 03 00	ÜÇLÜ TOP.LI GRUP PRİZ(Ç.K.)(3 MT)	3 GANG EARTHED GROUP SOCKET(CHILD PROTEC.)(3 MT)
001 175 310002 05 00	ÜÇLÜ TOP.LI GRUP PRİZ(Ç.K.)(5 MT)	3 GANG EARTHED GROUP SOCKET(CHILD PROTEC.)(5 MT)
001 175 320001 00 00	ÜÇLÜ ANAHT. TOP.LI GRUP PRİZ(Ç.K.)(KLEMENSLİ)	3 GANG EARTHED GROUP SOCKET(CHILD PROTEC.)(W/OUT CABLE+ SWITCH)
001 175 320002 02 00	ÜÇLÜ ANAHT. TOP.LI GRUP PRİZ(Ç.K.)(2 MT)	3 GANG EARTHED GROUP SOCKET(CHILD PROTEC.)(WITH SWITCH)(2 MT)
001 175 320002 03 00	ÜÇLÜ ANAHT. TOP.LI GRUP PRİZ(Ç.K.)(3 MT)	3 GANG EARTHED GROUP SOCKET(CHILD PROTEC.)(WITH SWITCH)(3 MT)
001 175 320002 05 00	ÜÇLÜ ANAHT. TOP.LI GRUP PRİZ(Ç.K.)(5 MT)	3 GANG EARTHED GROUP SOCKET(CHILD PROTEC.)(WITH SWITCH)(5 MT)
001 175 330001 00 00	ÜÇLÜ UPS GRUP PRİZ(Ç.K.)(KLEMENSLİ)	3 GANG UPS GROUP SOCKET(CHILD PROTEC.)(W/OUT CABLE)
001 175 330002 02 00	ÜÇLÜ UPS GRUP PRİZ(Ç.K.)(2 MT)	3 GANG UPS GROUP SOCKET(CHILD PROTEC.)(2 MT)
001 175 330002 03 00	ÜÇLÜ UPS GRUP PRİZ(Ç.K.)(3 MT)	3 GANG UPS GROUP SOCKET(CHILD PROTEC.)(3 MT)
001 175 330002 05 00	ÜÇLÜ UPS GRUP PRİZ(Ç.K.)(5 MT)	3 GANG UPS GROUP SOCKET(CHILD PROTEC.)(5 MT)
001 175 340001 00 00	ÜÇLÜ ANAHT. UPS GRUP PRİZ(Ç.K.)(KLEMENSLİ)	3 GANG UPS GROUP SOCKET(CHILD PROTEC.)(W/OUT CABLE+ SWITCH)
001 175 340002 02 00	ÜÇLÜ ANAHT. UPS GRUP PRİZ(Ç.K.)(2 MT)	3 GANG UPS GROUP SOCKET(CHILD PROTEC.)(WITH SWITCH)(2 MT)
001 175 340002 03 00	ÜÇLÜ ANAHT. UPS GRUP PRİZ(Ç.K.)(3 MT)	3 GANG UPS GROUP SOCKET(CHILD PROTEC.)(WITH SWITCH)(3 MT)
001 175 340002 05 00	ÜÇLÜ ANAHT. UPS GRUP PRİZ(Ç.K.)(5 MT)	3 GANG UPS GROUP SOCKET(CHILD PROTEC.)(WITH SWITCH)(5 MT)
001 175 350001 00 00	ÜÇLÜ USB ANAHT. TOP.LI GRUP PRİZ(Ç.K.)(KLEMENSLİ)	3 GANG UPS EARTHED GROUP SOCKET(CHILD PROTEC.)(W/OUT CABLE- +SWITCH)
001 175 350002 02 00	ÜÇLÜ USB ANAHT. TOP.LI GRUP PRİZ(Ç.K.)(2 MT)	3 GANG UPS EARTHED GROUP SOCKET(CHILD PROTEC.)(WITH SWITCH)(2 MT)
001 175 350002 03 00	ÜÇLÜ USB ANAHT. TOP.LI GRUP PRİZ(Ç.K.)(3 MT)	3 GANG UPS EARTHED GROUP SOCKET(CHILD PROTEC.)(WITH SWITCH)(3 MT)
001 175 350002 05 00	ÜÇLÜ USB ANAHT. TOP.LI GRUP PRİZ(Ç.K.)(5 MT)	3 GANG UPS EARTHED GROUP SOCKET(CHILD PROTEC.)(WITH SWITCH)(5 MT)
001 175 410001 00 00	DÖRTLÜ TOP.LI GRUP PRİZ(Ç.K.)(KLEMENSLİ)	4 GANG EARTHED GROUP SOCKET(CHILD PROTEC.)(W/OUT CABLE)
001 175 410002 02 00	DÖRTLÜ TOP.LI GRUP PRİZ(Ç.K.)(2 MT)	4 GANG EARTHED GROUP SOCKET(CHILD PROTEC.)(2 MT)
001 175 410002 03 00	DÖRTLÜ TOP.LI GRUP PRİZ(Ç.K.)(3 MT)	4 GANG EARTHED GROUP SOCKET(CHILD PROTEC.)(3 MT)
001 175 410002 05 00	DÖRTLÜ TOP.LI GRUP PRİZ(Ç.K.)(5 MT)	4 GANG EARTHED GROUP SOCKET(CHILD PROTEC.)(5 MT)
001 175 420001 00 00	DÖRTLÜ ANAHT. TOP.LI GRUP PRİZ(Ç.K.)(KLEMENSLİ)	4 GANG EARTHED GROUP SOCKET(CHILD PROTEC.)(W/OUT CABLE+ SWITCH)
001 175 420002 02 00	DÖRTLÜ ANAHT. TOP.LI GRUP PRİZ(Ç.K.)(2 MT)	4 GANG EARTHED GROUP SOCKET(CHILD PROTEC.)(WITH SWITCH)(2 MT)
001 175 420002 03 00	DÖRTLÜ ANAHT. TOP.LI GRUP PRİZ(Ç.K.)(3 MT)	4 GANG EARTHED GROUP SOCKET(CHILD PROTEC.)(WITH SWITCH)(3 MT)
001 175 420002 05 00	DÖRTLÜ ANAHT. TOP.LI GRUP PRİZ(Ç.K.)(5 MT)	4 GANG EARTHED GROUP SOCKET(CHILD PROTEC.)(WITH SWITCH)(5 MT)
001 175 430001 00 00	DÖRTLÜ UPS GRUP PRİZ(Ç.K.)(KLEMENSLİ)	4 GANG UPS GROUP SOCKET(CHILD PROTEC.)(W/OUT CABLE)
001 175 430002 02 00	DÖRTLÜ UPS GRUP PRİZ(Ç.K.)(2 MT)	4 GANG UPS GROUP SOCKET(CHILD PROTEC.)(2 MT)
001 175 430002 03 00	DÖRTLÜ UPS GRUP PRİZ(Ç.K.)(3 MT)	4 GANG UPS GROUP SOCKET(CHILD PROTEC.)(3 MT)
001 175 430002 05 00	DÖRTLÜ UPS GRUP PRİZ(Ç.K.)(5 MT)	4 GANG UPS GROUP SOCKET(CHILD PROTEC.)(5 MT)
001 175 440001 00 00	DÖRTLÜ ANAHT. UPS GRUP PRİZ(Ç.K.)(KLEMENSLİ)	4 GANG UPS GROUP SOCKET(CHILD PROTEC.)(W/OUT CABLE+ SWITCH)
001 175 440002 02 00	DÖRTLÜ ANAHT. UPS GRUP PRİZ(Ç.K.)(2 MT)	4 GANG UPS GROUP SOCKET(CHILD PROTEC.)(WITH SWITCH)(2 MT)
001 175 440002 03 00	DÖRTLÜ ANAHT. UPS GRUP PRİZ(Ç.K.)(3 MT)	4 GANG UPS GROUP SOCKET(CHILD PROTEC.)(WITH SWITCH)(3 MT)
001 175 440002 05 00	DÖRTLÜ ANAHT. UPS GRUP PRİZ(Ç.K.)(5 MT)	4 GANG UPS GROUP SOCKET(CHILD PROTEC.)(WITH SWITCH)(5 MT)
001 175 610001 00 00	ALTILI TOP.LI GRUP PRİZ(Ç.K.)(KLEMENSLİ)	6 GANG EARTHED GROUP SOCKET(CHILD PROTEC.)(W/OUT CABLE)
001 175 610002 02 00	ALTILI TOP.LI GRUP PRİZ(Ç.K.)(2 MT)	6 GANG EARTHED GROUP SOCKET(CHILD PROTEC.)(2 MT)
001 175 610002 03 00	ALTILI TOP.LI GRUP PRİZ(Ç.K.)(3 MT)	6 GANG EARTHED GROUP SOCKET(CHILD PROTEC.)(3 MT)
001 175 610002 05 00	ALTILI TOP.LI GRUP PRİZ(Ç.K.)(5 MT)	6 GANG EARTHED GROUP SOCKET(CHILD PROTEC.)(5 MT)
001 175 620001 00 00	ALTILI ANAHT. TOP.LI GRUP PRİZ(Ç.K.)(KLEMENSLİ)	6 GANG EARTHED GROUP SOCKET(CHILD PROTEC.)(W/OUT CABLE+ SWITCH)
001 175 620002 02 00	ALTILI ANAHT. TOP.LI GRUP PRİZ(Ç.K.)(2 MT)	6 GANG EARTHED GROUP SOCKET(CHILD PROTEC.)(WITH SWITCH)(2 MT)
001 175 620002 03 00	ALTILI ANAHT. TOP.LI GRUP PRİZ(Ç.K.)(3 MT)	6 GANG EARTHED GROUP SOCKET(CHILD PROTEC.)(WITH SWITCH)(3 MT)
001 175 620002 05 00	ALTILI ANAHT. TOP.LI GRUP PRİZ(Ç.K.)(5 MT)	6 GANG EARTHED GROUP SOCKET(CHILD PROTEC.)(WITH SWITCH)(5 MT)
001 175 630001 00 00	ALTILI UPS GRUP PRİZ(Ç.K.)(KLEMENSLİ)	6 GANG UPS GROUP SOCKET(CHILD PROTEC.)(W/OUT CABLE)
001 175 630002 02 00	ALTILI UPS GRUP PRİZ(Ç.K.)(2 MT)	6 GANG UPS GROUP SOCKET(CHILD PROTEC.)(2 MT)
001 175 630002 03 00	ALTILI UPS GRUP PRİZ(Ç.K.)(3 MT)	6 GANG UPS GROUP SOCKET(CHILD PROTEC.)(3 MT)
001 175 630002 05 00	ALTILI UPS GRUP PRİZ(Ç.K.)(5 MT)	6 GANG UPS GROUP SOCKET(CHILD PROTEC.)(5 MT)
001 175 640001 00 00	ALTILI ANAHT. UPS GRUP PRİZ(Ç.K.)(KLEMENSLİ)	6 GANG UPS GROUP SOCKET(CHILD PROTEC.)(W/OUT CABLE+ SWITCH)
001 175 640002 02 00	ALTILI ANAHT. UPS GRUP PRİZ(Ç.K.)(2 MT)	6 GANG UPS GROUP SOCKET(CHILD PROTEC.)(WITH SWITCH)(2 MT)
001 175 640002 03 00	ALTILI ANAHT. UPS GRUP PRİZ(Ç.K.)(3 MT)	6 GANG UPS GROUP SOCKET(CHILD PROTEC.)(WITH SWITCH)(3 MT)
001 175 640002 05 00	ALTILI ANAHT. UPS GRUP PRİZ(Ç.K.)(5 MT)	6 GANG UPS GROUP SOCKET(CHILD PROTEC.)(WITH SWITCH)(5 MT)
001 175 650001 00 00	ALTILI USB ANAHT. TOP.LI GRUP PRİZ(Ç.K.)(KLEMENSLİ)	6 GANG UPS EARTHED GROUP SOCKET(CHILD PROTEC.)(W/OUT CABLE+ SWITCH)
001 175 650002 02 00	ALTILI USB ANAHT. TOP.LI GRUP PRİZ(Ç.K.)(2 MT)	6 GANG UPS EARTHED GROUP SOCKET(CHILD PROTEC.)(WITH SWITCH)(2 MT)
001 175 650002 03 00	ALTILI USB ANAHT. TOP.LI GRUP PRİZ(Ç.K.)(3 MT)	6 GANG UPS EARTHED GROUP SOCKET(CHILD PROTEC.)(WITH SWITCH)(3 MT)
001 175 650002 05 00	ALTILI USB ANAHT. TOP.LI GRUP PRİZ(Ç.K.)(5 MT)	6 GANG UPS EARTHED GROUP SOCKET(CHILD PROTEC.)(WITH SWITCH)(5 MT)
001 175 660001 00 00	ALTILI AKIM.KOR. USB ANAHT. TOP.LI GRUP PRİZ(Ç.K.)(KL.)	6 GANG EARTHED GROUP SOCKET WITH CURRENT PROT. 2XUSB CHARGER (CHILD P.+ W. SWITCH) W/OUT CABLE
001 175 660002 02 00	ALTILI AKIM.KOR. USB ANAHT. TOP.LI GRUP PRİZ(Ç.K.)(2 MT)	6 GANG EARTHED GROUP SOCKET WITH CURRENT PROT. 2XUSB CHARGER (CHILD P.+ W. SWITCH) 2MT
001 175 660002 03 00	ALTILI AKIM.KOR. USB ANAHT. TOP.LI GRUP PRİZ(Ç.K.)(3 MT)	6 GANG EARTHED GROUP SOCKET WITH CURRENT PROT. 2XUSB CHARGER (CHILD P.+ W. SWITCH) 3 MT
001 175 660002 05 00	ALTILI AKIM.KOR. USB ANAHT. TOP.LI GRUP PRİZ(Ç.K.)(5 MT)	6 GANG EARTHED GROUP SOCKET WITH CURRENT PROT 2XUSB CHARGER (CHILD P.+ W. SWITCH) 5 MT

Ürün Listesi

Product List

Kod / Code	Ürün Tanımı	Description
001 171 210001 00 00	İKİLİ TOPRAKLI GRUP PRİZ(KLEMENSLİ)	2 GANG EARTHED SOCKET (WITH TERMINAL)
001 171 210002 02 00	İKİLİ TOPRAKLI GRUP PRİZ(2 MT)	2 GANG EARTHED SOCKET OUTLET (2 mt cord)
001 171 210002 03 00	İKİLİ TOPRAKLI GRUP PRİZ(3 MT)	2 GANG EARTHED SOCKET OUTLET (3 mt cord)
001 171 210002 05 00	İKİLİ TOPRAKLI GRUP PRİZ(5 MT)	2 GANG EARTHED SOCKET OUTLET (5 mt cord)
001 171 290001 00 00	İKİLİ TOPRAKSIZ GRUP PRİZ(KLEMENSLİ)	2 GANG GROUP SOCKET OUTLET CORDLESS
001 171 290002 02 00	İKİLİ TOPRAKSIZ GRUP PRİZ(2 MT)	2 GANG GROUP SOCKET (2 mt)
001 171 290002 03 00	İKİLİ TOPRAKSIZ GRUP PRİZ(3 MT)	2 GANG GROUP SOCKET (3 mt)
001 171 290002 05 00	İKİLİ TOPRAKSIZ GRUP PRİZ(5 MT)	2 GANG GROUP SOCKET (5 mt)
001 171 390001 00 00	ÜÇLÜ TOPRAKSIZ GRUP PRİZ(KLEMENSLİ)	3 GANG GROUP SOCKET (WITH TERMINAL)
001 171 390002 02 00	ÜÇLÜ TOPRAKSIZ GRUP PRİZ(2MT)	3 GANG SOCKET SOCKET OUTLET (2 mt cord)
001 171 390002 03 00	ÜÇLÜ TOPRAKSIZ GRUP PRİZ(3MT)	3 GANG SOCKET SOCKET OUTLET (3 mt cord)
001 171 390002 05 00	ÜÇLÜ TOPRAKSIZ GRUP PRİZ(5MT)	3 GANG SOCKET SOCKET OUTLET (5 mt cord)
001 171 310001 00 00	ÜÇLÜ TOPRAKLI GRUP PRİZ(KLEMENSLİ)	3 GANG EARTHED SOCKET (WITH TERMINAL)
001 171 310002 02 00	ÜÇLÜ TOPRAKLI GRUP PRİZ(2MT)	3 GANG EARTHED SOCKET (2 mt)
001 171 310002 03 00	ÜÇLÜ TOPRAKLI GRUP PRİZ(3MT)	3 GANG EARTHED SOCKET (3 mt)
001 171 310002 05 00	ÜÇLÜ TOPRAKLI GRUP PRİZ(5MT)	3 GANG EARTHED SOCKET (5 mt)
001 171 320001 00 00	ÜÇLÜ TOPRAKLI GRUP PRİZ(KLEMENSLİ-ANAHTARLI)	3 GANG EARTHED SOCKET (WITH TERMINAL AND SWITCH)
001 171 320002 02 00	ÜÇLÜ TOPRAKLI GRUP PRİZ(ANAHTARLI 2 MT)	3 GANG EARTHED SOCKET (WITH SWITCH 2 mt)
001 171 320002 03 00	ÜÇLÜ TOPRAKLI GRUP PRİZ(ANAHTARLI 3 MT)	3 GANG EARTHED SOCKET (WITH SWITCH 3 mt)
001 171 320002 05 00	ÜÇLÜ TOPRAKLI GRUP PRİZ(ANAHTARLI 5 MT)	3 GANG EARTHED SOCKET (WITH SWITCH 5 mt)
001 171 340001 00 00	ÜÇLÜ UPS GRUP PRİZ(KLEMENSLİ)	EARTHED 3 GANG UPS SOCKET (WITH TERMINAL)
001 171 330001 02 00	ÜÇLÜ UPS GRUP PRİZ(2MT)	3 GANG UPS EARTHED (2 mt)
001 171 330001 03 00	ÜÇLÜ UPS GRUP PRİZ(3MT)	3 GANG UPS EARTHED (3 mt)
001 171 330001 05 00	ÜÇLÜ UPS GRUP PRİZ(5MT)	3 GANG UPS EARTHED (5 mt)
001 171 410001 00 00	DÖRTLÜ TOPRAKLI GRUP PRİZ(KLEMENSLİ)	4 GANG EARTHED SOCKET (WITH TERMINAL)
001 171 410001 02 00	DÖRTLÜ TOPRAKLI GRUP PRİZ(2MT)	4 GANG EARTHED SOCKET (2 mt)
001 171 410001 03 00	DÖRTLÜ TOPRAKLI GRUP PRİZ(3MT)	4 GANG EARTHED SOCKET (3 mt)
001 171 410001 05 00	DÖRTLÜ TOPRAKLI GRUP PRİZ(5MT)	4 GANG EARTHED SOCKET (5 mt)
001 171 410002 00 00	DÖRTLÜ TOPRAKLI GRUP PRİZ(KLEMENSLİ-ANAHTARLI)	4 GANG EARTHED SOCKET (WITH TERMINAL AND SWITCH)
001 171 410002 02 00	DÖRTLÜ TOPRAKLI GRUP PRİZ(ANAHTARLI 2 MT)	4 GANG EARTHED SOCKET(WITH SWITCH 2 mt)
001 171 410002 03 00	DÖRTLÜ TOPRAKLI GRUP PRİZ(ANAHTARLI 3 MT)	4 GANG EARTHED SOCKET(WITH SWITCH 3 mt)
001 171 410002 05 00	DÖRTLÜ TOPRAKLI GRUP PRİZ(ANAHTARLI 5 MT)	4 GANG EARTHED SOCKET(WITH SWITCH 5 mt)
001 171 610001 00 00	ALTILI TOPRAKLI GRUP PRİZ(KLEMENSLİ)	6 GANG EARTHED SOCKET (WITH TERMINAL)
001 171 610001 02 00	ALTILI TOPRAKLI GRUP PRİZ(2 MT)	6 GANG EARTHED SOCKET (2 mt)
001 171 610001 03 00	ALTILI TOPRAKLI GRUP PRİZ(3 MT)	6 GANG EARTHED SOCKET (3 mt)
001 171 610001 05 00	ALTILI TOPRAKLI GRUP PRİZ(5 MT)	6 GANG EARTHED SOCKET (5 mt)
001 171 610002 00 00	ALTILI TOPRAKLI GRUP PRİZ(KLEMENSLİ-ANAHTARLI)	6 GANG EARTHED SOCKET (WITH TERMINAL AND SWITCH)
001 171 610002 02 00	ALTILI TOPRAKLI GRUP PRİZ(ANAHTARLI 2 MT)	6 GANG EARTHED SOCKET(WITH SWITCH 2 mt)
001 171 610002 03 00	ALTILI TOPRAKLI GRUP PRİZ(ANAHTARLI 3 MT)	6 GANG EARTHED SOCKET(WITH SWITCH 3 mt)
001 171 610002 05 00	ALTILI TOPRAKLI GRUP PRİZ(ANAHTARLI 5 MT)	6 GANG EARTHED SOCKET(WITH SWITCH 5 mt)

Aksesuarlar

ACCESSORIES



AKSESUARLAR • ACCESSORIES

Accessories



ÜRÜN LİSTESİ • PRODUCT LIST

Kod • Code	Ürün Tanımı		Description
001 170 011001 00 00	TOPRAKLI ERKEK FİŞ	CE	EARTHED MALE PLUG
001 170 011002 00 00	KULPLU TOPRAKLI ERKEK FİŞ	CE	EARTHED MALE PLUG WITH HANDLE
001 170 013001 00 00	TOPRAKLI ERKEK FİŞ - UPS (KUYRUKLU)	CE	EARTHED MALE PLUG USB (TAILED)
001 170 012001 00 00	TOPRAKLI ERKEK FİŞ (KUYRUKLU)	CE	EARTHED MALE PLUG (TAILED)
001 170 021001 00 00	TOPRAKLI DIŞI FİŞ	CE	EARTHED FEMALE PLUG
001 170 010001 00 00	ERKEK FİŞ		MALE SOCKET
001 170 020001 00 00	DIŞI FİŞ		FEMALE SOCKET
001 170 033001 00 00	TOPRAKLI ÜÇLÜ FİŞ-PRİZ (YONCA TİP) (SIVAALTI)	CE	TRIPLE EARTHED SOCKET - SWITCH (YONCA TYPE) (RECESSED MOUNTED)
001 170 033002 00 00	TOPRAKLI ÜÇLÜ FİŞ-PRİZ (YONCA TİP) (SIVAÜSTÜ)	CE	TRIPLE EARTHED SOCKET - SWITCH (YONCA TYPE) (SURFACE MOUNTED)
001 170 030002 00 00	ADAPTÖR FİŞ - PRİZ (İNGİLİZ TİP)	CE	ADAPTER - SOCKET (BRITISH TYPE)
001 170 030001 00 00	ARAPUAR ANAHTAR	CE	BAKALITE HAND SWITCH
001 170 033003 00 00	İKİLİ TOPRAKLI FİŞ - PRİZ (DÜZ TİP)	CE	EARTHED 2 GANG SOCKET
001 170 033005 00 00	ÜÇLÜ TOPRAKLI FİŞ - PRİZ (DÜZ TİP)	CE	EARTHED 3 GANG SOCKET
001 170 033004 00 00	ÜÇLÜ TOPRAKLI FİŞ - PRİZ (DÜZ TİP ANAHTARLI)	CE	EARTHED 3 GANG SOCKET (WITH SWITCH)

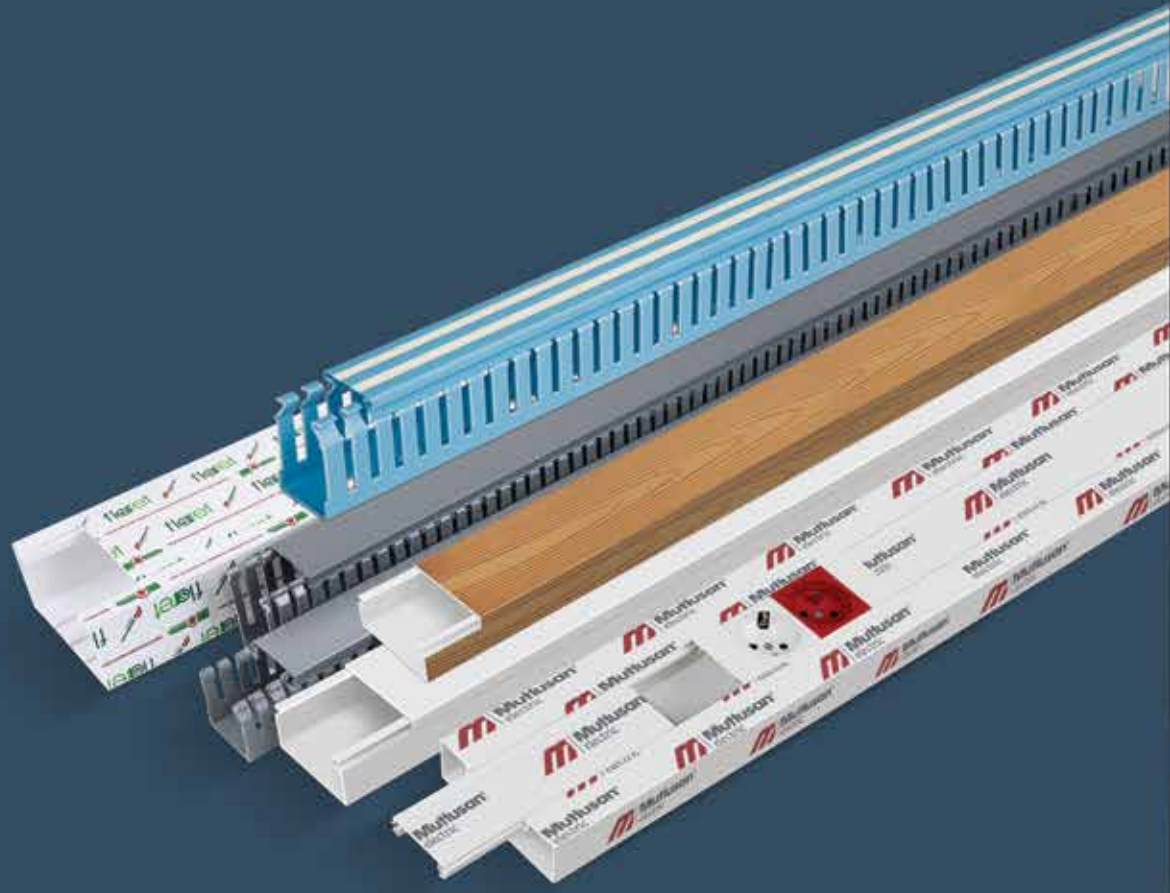

Kablo Kanalları • Cable Trunking

Renkli Kablo Kanalları • Colored Cable Trunking

Zemin Kablo Kanalları • Floor Cable Trunking

Delikli Kablo Kanalları • Slotted Cable Trunking



KABLO KANALLARI
CABLE TRUNKING

Neden Mutlusan kablo kanallarını kullanmalıyız?

Why we use should Mutlusan cable trunking?



1 Ürünlerimiz hafif ve dayanıklıdır,
Our products are light-weighted and durable,

2 Ürünlerimizin büyük çoğunluğunun aynı ebatlarda aksesuarları mevcuttur
Availability of cable trunking accessories with identical sizes for majority of our products,

3 İstenilen ölçülerde kesilebilir ve istenen renkte boyanabilir olma özelliği,
Our products can be tailor-cut to the desired dimensions and can be painted to desired color,

4 Zengin renk ve desenleriyle yapılarınızın dekorasyonu estetik bir uyum içerisinde oluşu,
Our products are in aesthetic harmony with the decoration of your buildings by virtue of rich color and pattern options,

5 Tadilatlı uygulamalar duvarda sıva hatalarına neden olurken, kablo kanalları uygulaması duvarlarınızın kırılıp dökülerek deforme olmasını önler,
While modification practices cause plaster errors on your walls, cable trunking applications prevent deformation of your walls due to demolition,

6 Kanal içindeki ray sistemiyle kabloların birbirinden bağımsız bir şekilde taşınabilmesi, aynı kanaldan birden fazla kablo geçirilebilir olması özelliği,
The rail system within the trunking enables installation of cables independently and multiple cables can be laid inside the same trunking,

7 Kablo kanallarındaki geçmeli sistemin montaj kolaylığı sağlar,
Ease of assembly through click-fit system at cable trunking,

8 Mükemmel kalıp tasarımı sayesinde üstün yüzey düzgünlüğü,
Superior surface smoothness by virtue of excellent die design,

9 Pano içi delikli kablo kanallarının endüstriyel uygulamalardaki esnek kablo döşemelerinde kullanılabilir
Perforated cable trunking can be used at flexible cable installations for industrial practices,

10 Priz ve anahtar montajında geçmeli montaj özelliği sayesinde pratik ve kolay sabitleme özelliği, kolay montaj,
Practical and easy fixation and easy assembly by virtue of click-fit assembly feature of power outlets and switches'

11 Kanal gövdesindeki delikler sayesinde hızlı montaj olanağı, sabitleme ayakları sayesinde kolay anahtar ve priz montajı yapılabilmesi
Quick assembly by virtue of pre-drilled perforations on the trunking body and easy switch and socket assembly by virtue of fixing tool,

12 Elektrik kablolarının ve bilgisayar sistemlerinin düzenlenmesinde, asansör ve doğalgaz boru kapatmalarında, prefabrik yapılar ve güvenlik sistemlerinde yaygın kullanım.
Extensive usage for arrangement of electrical wiring and computer systems, elevator and natural gas piping enclosures and prefabricated structures and security systems

Teknik özellikler

Technical specifications



Ultraviyole ışınlarına karşı dayanıklıdır.
Resistance to UV light.



Asit buharına dayanıklıdır.
Resistance to acidic vapor.



Darbelere dayanıklıdır.
Shock resistance.



Elektiriksel yalıtım özelliğine sahiptir.
Electrically insulated



Tüm kanallarımız çift taraflı yapışkanlı bant ile kullanılabilir.
Adhesive models are easy to install.



İstenilen renkte boyanabilir.
Can be painted to desired color.



Aşırı soğuğa ve ısıca karşı dayanıklı.
Resistant to extreme cold and heat.

IP4X

Katı yabancı maddelerin girişine karşı koruma.
Protection against ingress of solid foreign substances.

**Halogen Free
kablo kanalı**
Halogen free
cable trunking

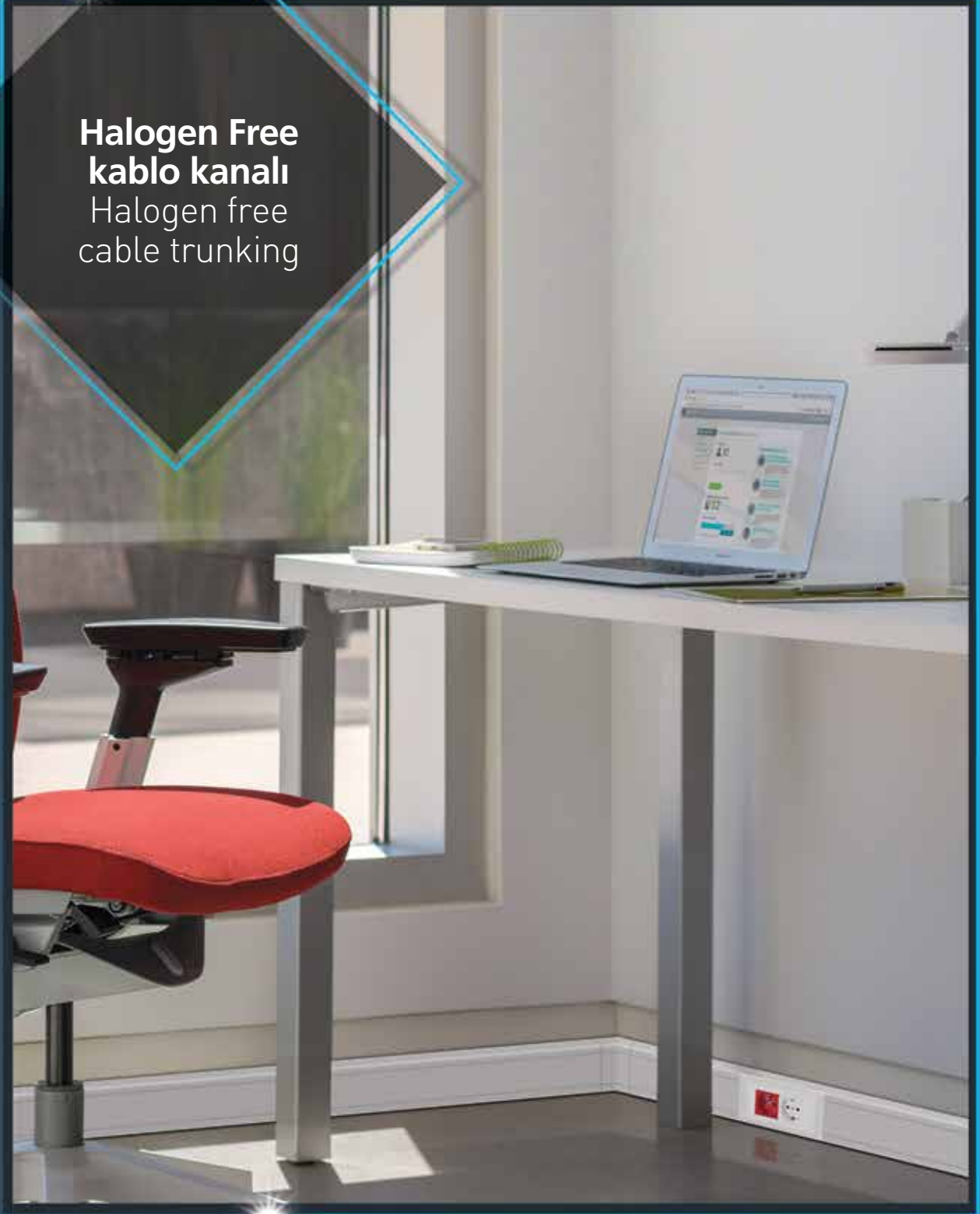

flaret

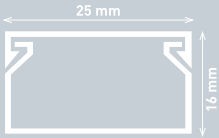

Flame Retardant
Alev Yaymayan

**25x16**

Ürün Kodu	Product Code	001 060 025016 20 00
Ambalaj Şekli	Packing Type	Kutu - Box
Adet / m	Quantity / m	150 m
Ağırlık	Weight	17,325 kg
m ³ /	Volume	0.07636

AKSESUARLAR - ACCESSORIES

Kod Code	Ürün Product	Adet Quantity	Ağırlık Weight	m ³ Volume
 001 039 025016 11 00	İç Köşe Internal Corner	40	0,390 kg	0,00293
 001 040 025016 11 00	Dış Köşe External Corner	40	0,484 kg	0,00293
 001 041 025016 11 00	T Köşe T Corner	30	0,395 kg	0,00293
 001 042 025016 11 00	90° L Köşe 90° L Corner	50	0,490 kg	0,00293
 001 043 025016 11 00	Ek Parça Connector	100	0,260 kg	0,00139
 001 044 025016 11 00	Uç Tapa Blind Cap	100	0,240 kg	0,00139
 001 047 017421 11 00	PM Kasası 1'li Socket Assembly Frame Single	12	1,290 kg	0,00600

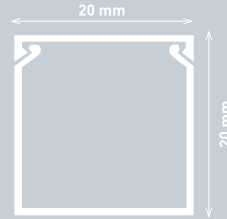
**25x25**

Ürün Kodu	Product Code	001 060 025025 20 00
Ambalaj Şekli	Packing Type	Kutu - Box
Adet / m	Quantity / m	100 m
Ağırlık	Weight	15,500 kg
m ³ /	Volume	0.07636

AKSESUARLAR - ACCESSORIES

Kod Code	Ürün Product	Adet Quantity	Ağırlık Weight	m ³ Volume
 001 039 025025 11 00	İç Köşe Internal Corner	40	0,424 kg	0,00293
 001 040 025025 11 00	Dış Köşe External Corner	40	0,516 kg	0,00293
 001 041 025025 11 00	T Köşe T Corner	30	0,405 kg	0,00293
 001 042 025025 11 00	90° L Köşe 90° L Corner	50	0,516 kg	0,00293
 001 043 025025 11 00	Ek Parça Connector	100	0,184 kg	0,00139
 001 044 025025 11 00	Uç Tapa Blind Cap	100	0,310 kg	0,00139
 001 047 017421 11 00	PM Kasası 1'li Socket Assembly Frame Single	12	1,290 kg	0,00600





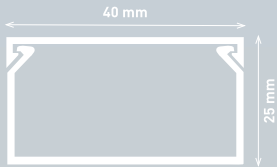



40x25



Ürün Kodu	Product Code	001 060 04025 20 00
Ambalaj Şekli	Packing Type	Kutu - Box
Adet / m	Quantity / m	80 m
Ağırlık	Weight	17,200 kg
m ³ /	Volume	0,09272

AKSESUARLAR - ACCESSORIES

Kod Code	Ürün Product	Adet Quantity	Ağırlık Weight	m ³ Volume
 001 039 040025 11 00	İç Köşe Internal Corner	24	0,449 kg	0,00293
 001 040 040025 11 00	Dış Köşe External Corner	30	0,711 kg	0,00293
 001 041 040025 11 00	T Köşe T Corner	18	0,407 kg	0,00293
 001 042 040025 11 00	90° L Köşe 90° L Corner	24	0,432 kg	0,00293
 001 043 040025 11 00	Ek Parça Connector	70	0,353 kg	0,00293
 001 044 040025 11 00	Uç Tapa Blind Cap	25	0,158 kg	0,00139



40x40

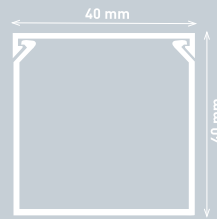

Ürün Kodu	Product Code	001 060 04040 20 00
Ambalaj Şekli	Packing Type	Kutu - Box
Adet / m	Quantity / m	50 m
Ağırlık	Weight	13,900 kg
m ³ /	Volume	0,08500

AKSESUARLAR - ACCESSORIES

Kod Code	Ürün Product	Adet Quantity	Ağırlık Weight	m ³ Volume
 001 039 040040 11 00	İç Köşe Internal Corner	18	0,504 kg	0,00282
 001 040 040040 11 00	Dış Köşe External Corner	10	0,320 kg	0,00282
 001 041 040040 11 00	T Köşe T Corner	48	1,415 kg	0,01011
 001 042 040040 11 00	90° L Köşe 90° L Corner	60	1,488 kg	0,01011
 001 043 040040 11 00	Ek Parça Connector	100	0,722 kg	0,01011
 001 044 040040 11 00	Uç Tapa Blind Cap	25	0,210 kg	0,00139



40x60

Aksesuarsız
Without Accessories







Ürün Kodu	Product Code	001 060 040060 20 00
Ambalaj Şekli	Packing Type	Kutu - Box
Adet / m	Quantity / m	30 m
Ağırlık	Weight	15,138 kg
m ³ /	Volume	0,07491



100x50

Aksesuarlar - Accessories

Ürün Kodu	Product Code	001 060 100050 20 00
Ambalaj Şekli	Packing Type	Kutu - Box
Adet / m	Quantity / m	20 m
Ağırlık	Weight	16,600 kg
m ³ /	Volume	0,12600

AKSESUARLAR - ACCESSORIES					
Kod Code	Ürün Product	Adet Quantity	Ağırlık Weight	m ³ Volume	
 001 061 100050 20 00	Ara Bölme Partition	150 m	74,250 kg	0,37455	
 001 039 100050 11 00	İç Köşe Hareketli Internal Corner Live	12	1,020 kg	0,00960	
 001 040 100050 11 00	Dış Köşe Hareketli External Corner Live	10	1,140 kg	0,01000	
 001 041 100050 11 00	T Köşe T Corner	10	1,000 kg	0,01364	
 001 042 100050 11 00	90° L Köşe 90° L Corner	10	1,000 kg	0,01364	
 001 043 100050 11 00	Ek Parça Connector	100	1,650 kg	0,01000	
 001 44 100050 11 00	Uç Tapa Blind Cap	40	0,735 kg	0,00400	

100x50

Kendinden kapaklı kanallar
Cable trunking with
internal cover

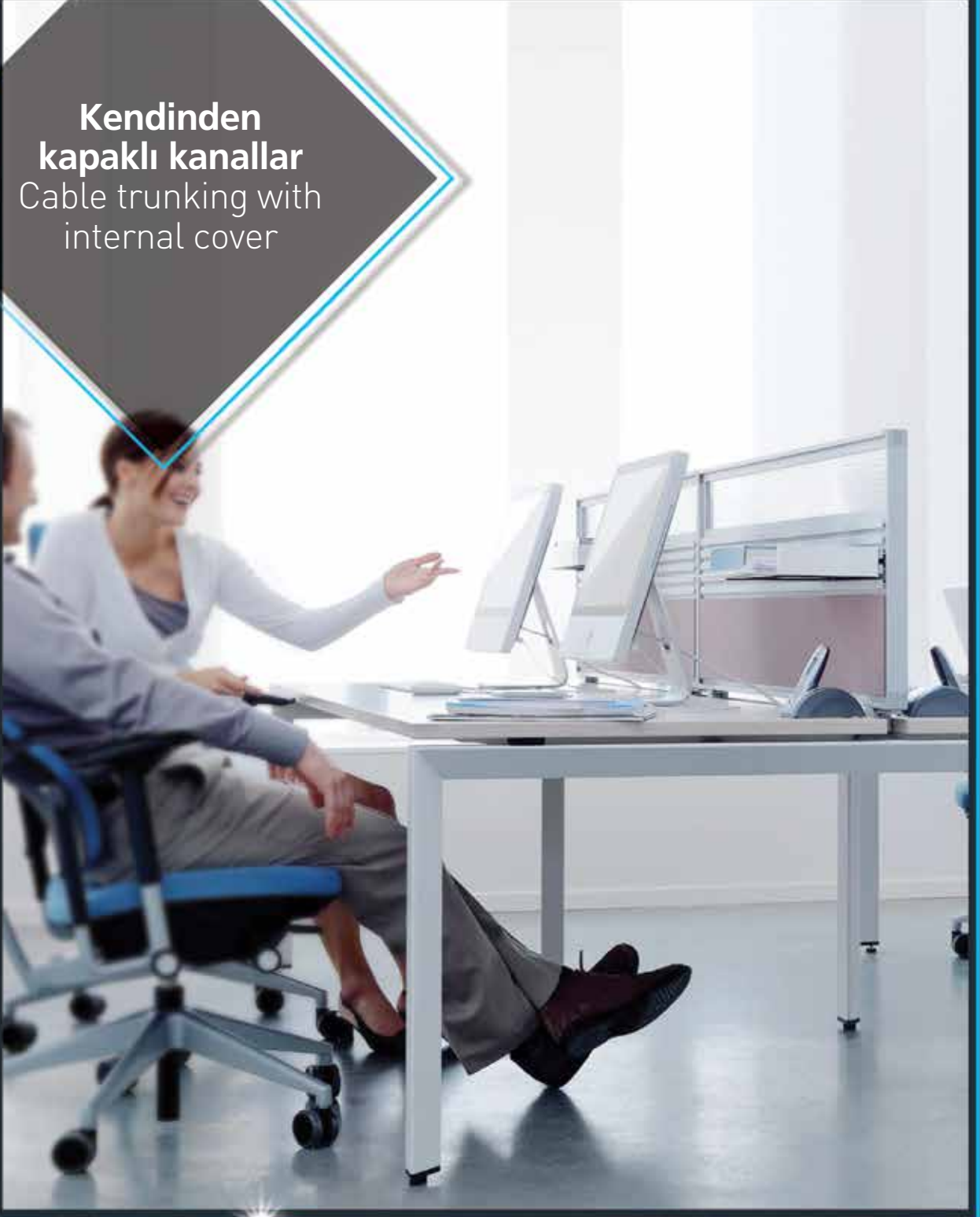

Kendinden Yapışkanlı
Self-Adhesive



Kendinden Kapaklı
Intrincis Cover

**9x5****Aksesuarsız**
Without Accessories

Ürün Kodu	Product Code	001 004 009005 20 00
Ambalaj Şekli	Packing Type	Kutu - Box
Adet / m	Quantity / m	500 m
Ağırlık	Weight	18,400 kg
m ³ /	Volume	0,04350

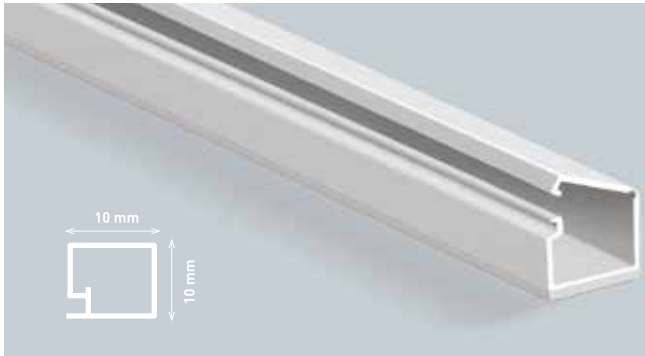
**10x10****Aksesuarsız**
Without Accessories

Ürün Kodu	Product Code	001 004 010010 20 00
Ambalaj Şekli	Packing Type	Kutu - Box
Adet / m	Quantity / m	320 m
Ağırlık	Weight	18,176 kg
m ³ /	Volume	0,04000

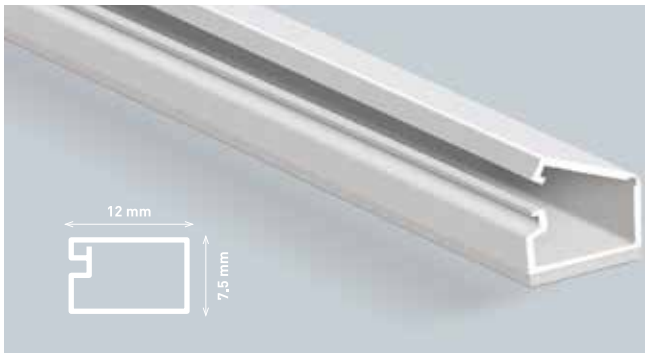
**12x7.5****Aksesuarsız**
Without Accessories

Ürün Kodu	Product Code	001 004 012007 20 00
Ambalaj Şekli	Packing Type	Kutu - Box
Adet / m	Quantity / m	350 m
Ağırlık	Weight	18,340 kg
m ³ /	Volume	0,05110

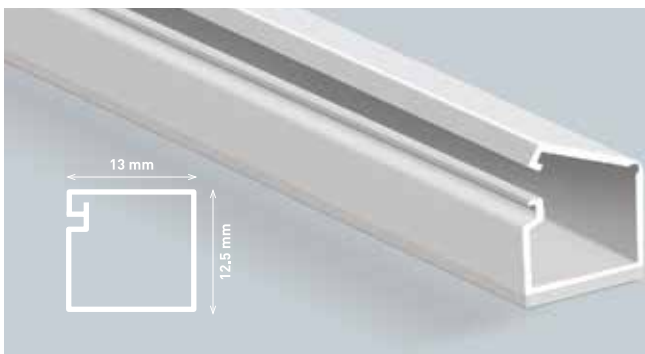
**13x12.5****Aksesuarsız**
Without Accessories

Ürün Kodu	Product Code	001 004 013012 20 00
Ambalaj Şekli	Packing Type	Kutu - Box
Adet / m	Quantity / m	300 m
Ağırlık	Weight	24,090 kg
m ³ /	Volume	0,05040

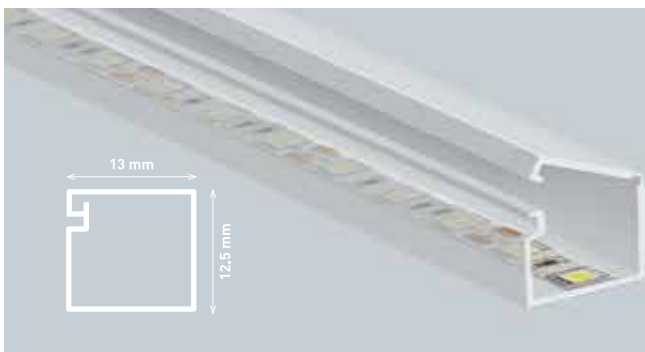
LED
için özel**13x12.5****Şeffaf Kanal**
Transparent Cable Trunking

Ürün Kodu	Product Code	001 004 013012 20 44
Ambalaj Şekli	Packing Type	Kutu - Box
Adet / m	Quantity / m	300 m
Ağırlık	Weight	18,210 kg
m ³ /	Volume	0,05040

**Dıştan kapaklı
kanallar**
Cable trunking with
external cover

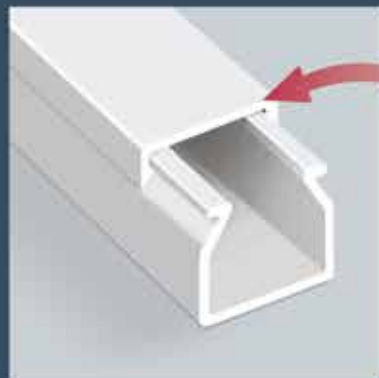

Dıştan Kapaklı
External Cover

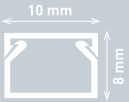

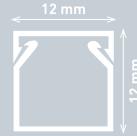

**10x8****Aksesuarsız**
Without Accessories

		EKO Serisi Series	MEKS Serisi Series
Ürün Kodu	Product Code	001 014 010008 20 00	001 002 010008 20 00
Ambalaj Şekli	Packing Type	Kutu - Box	Kutu - Box
Adet / m	Quantity / m	330 m	330 m
Ağırlık	Weight	17,500	17,500
m ³ /	Volume	0,04257	0,03300

**12x12**

		EKO Serisi Series	MEKS Serisi Series	CANALEX Serisi Series
Ürün Kodu	Product Code	001 014 012012 20 00	001 002 012012 20 00	001 156 012012 20 00
Ambalaj Şekli	Packing Type	Kutu - Box	Kutu - Box	Kutu - Box
Adet / m	Quantity / m	250 m	250 m	250 m
Ağırlık	Weight	17,050 kg	17,050 kg	14,800 kg
m ³ /	Volume	0,05000	0,05000	0,05000

**AKSESUARLAR - ACCESSORIES**

	Kod Code	Ürün Product	Adet Quantity	Ağırlık Weight	m ³ Volume
	001 039 012012 00 00	İç Köşe Internal Corner	60	0,175 kg	0,00139
	001 040 012012 00 00	Dış Köşe External Corner	60	0,215 kg	0,00139
	001 041 012012 00 00	T Köşe T Corner	60	0,195 kg	0,00139
	001 042 012012 00 00	90° L Köşe 90° L Corner	60	0,225 kg	0,00139
	001 043 012012 00 00	Ek Parça Connector	100	0,165 kg	0,00139
	001 044 012012 00 00	Uç Tapa Blind Cap	100	0,145 kg	0,00139

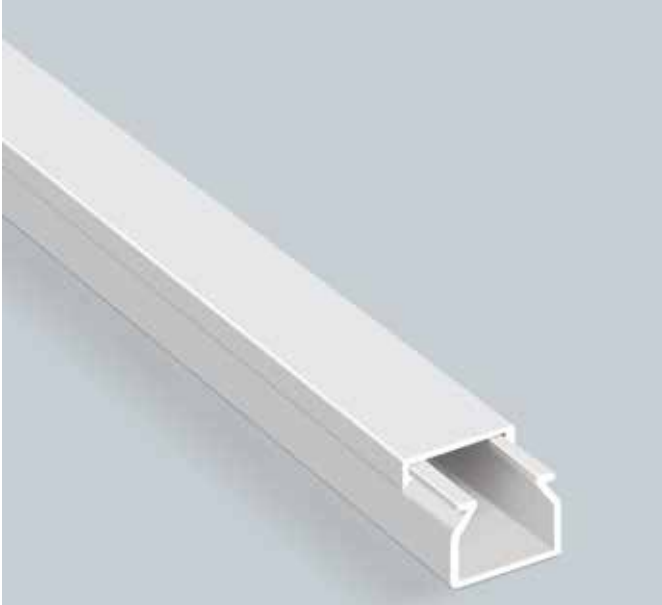

15x10

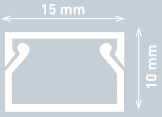

		EKO Serisi Series	MEKS Serisi Series	CANALEX Serisi Series
Ürün Kodu	Product Code	001 014 015010 20 00	001 002 015010 20 00	001 156 015010 20 00
Ambalaj Şekli	Packing Type	Kutu - Box	Kutu - Box	Kutu - Box
Adet / m	Quantity / m	250 m	250 m	250 m
Ağırlık	Weight	19,800 kg	19,800 kg	14,800 kg
m ³ /	Volume	0,05050	0,05050	0,05050

AKSESUARLAR - ACCESSORIES

	Kod Code	Ürün Product	Adet Quantity	Ağırlık Weight	m ³ Volume
	001 039 015010 00 00	İç Köşe Internal Corner	60	0,195 kg	0,00139
	001 040 015010 00 00	Dış Köşe External Corner	60	0,220 kg	0,00139
	001 041 015010 00 00	T Köşe T Corner	60	0,240 kg	0,00139
	001 042 015010 00 00	90° L Köşe 90° L Corner	60	0,190 kg	0,00139
	001 043 015010 00 00	Ek Parça Connector	100	0,250 kg	0,00139
	001 044 015010 00 00	Uç Tapa Blind Cap	100	0,150 kg	0,00139

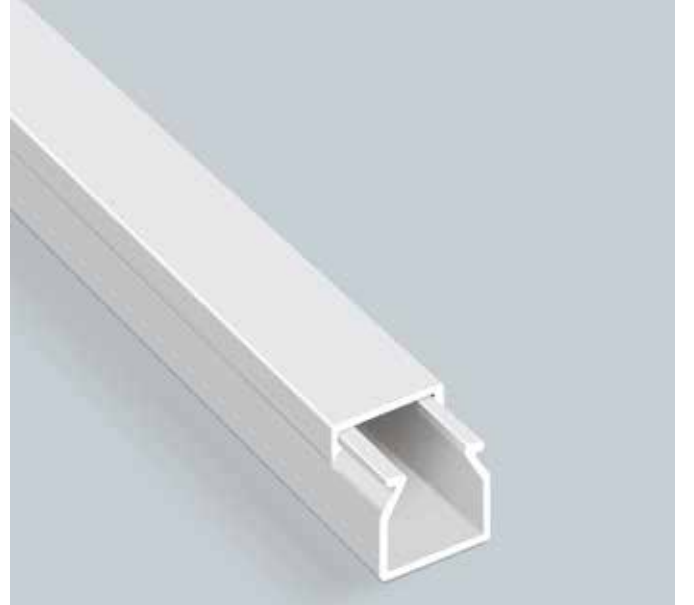

15x15

Aksesuarsız
Without Accessories

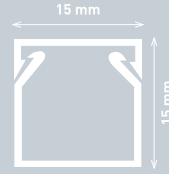

		EKO Serisi Series	MEKS Serisi Series
Ürün Kodu	Product Code	001 014 015015 20 00	001 002 015015 20 00
Ambalaj Şekli	Packing Type	Kutu - Box	Kutu - Box
Adet / m	Quantity / m	250 m	250 m
Ağırlık	Weight	23 kg	23 kg
m ³ /	Volume	0,08483	0,08483





16x16

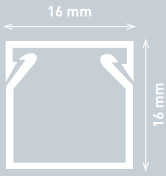

		EKO Serisi Series	MEKS Serisi Series	CANALEX Serisi Series
Ürün Kodu	Product Code	001 014 016016 20 00	001 002 016016 20 00	001 156 016016 20 00
Ambalaj Şekli	Packing Type	Kutu - Box	Kutu - Box	Kutu - Box
Adet / m	Quantity / m	250 m	250 m	250 m
Ağırlık	Weight	26,900 kg	27,390 kg	20,650 kg
m ³ /	Volume	0,07500	0,07500	0,07500

AKSESUARLAR - ACCESSORIES

	Kod Code	Ürün Product	Adet Quantity	Ağırlık Weight	m ³ Volume
	001 039 016016 00 00	İç Köşe Internal Corner	60	0,240 kg	0,00293
	001 040 016016 00 00	Dış Köşe External Corner	60	0,265 kg	0,00293
	001 041 016016 00 00	T Köşe T Corner	60	0,400 kg	0,00293
	001 042 016016 00 00	90° L Köşe 90° L Corner	60	0,330 kg	0,00293
	001 043 016016 00 00	Ek Parça Connector	100	0,250 kg	0,00139
	001 044 016016 00 00	Uç Tapa Blind Cap	100	0,190 kg	0,00139



20x10



		EKO Serisi Series	MEKS Serisi Series	CANALEX Serisi Series
Ürün Kodu	Product Code	001 014 020010 20 00	001 002 020010 20 00	001 156 020010 20 00
Ambalaj Şekli	Packing Type	Kutu - Box	Kutu - Box	Kutu - Box
Adet / m	Quantity / m	200 m	200 m	200 m
Ağırlık	Weight	17,050 kg	17,050 kg	15,060 kg
m ³ /	Volume	0,05040	0,05040	0,05040

AKSESUARLAR - ACCESSORIES

	Kod Code	Ürün Product	Adet Quantity	Ağırlık Weight	m ³ Volume
	001 039 020010 00 00	İç Köşe Internal Corner	60	0,200 kg	0,00139
	001 040 020010 00 00	Dış Köşe External Corner	60	0,245 kg	0,00139
	001 041 020010 00 00	T Köşe T Corner	30	0,170 kg	0,00139
	001 042 020010 00 00	90° L Köşe 90° L Corner	50	0,240 kg	0,00293
	001 043 020010 00 00	Ek Parça Connector	100	0,210 kg	0,00139
	001 044 020010 00 00	Uç Tapa Blind Cap	100	0,200 kg	0,00139



20x15



		EKO Serisi Series	MEKS Serisi Series
Ürün Kodu	Product Code	001 014 020015 20 00	001 002 020015 20 00
Ambalaj Şekli	Packing Type	Kutu - Box	Kutu - Box
Adet / m	Quantity / m	144 m	144 m
Ağırlık	Weight	15,120 kg	15,120 kg
m ³ /	Volume	0,07644	0,10995



20x20 | Aksesuarsız
Without Accessories



		EKO Serisi Series	MEKS Serisi Series
Ürün Kodu	Product Code	001 014 020020 20 00	001 002 020020 20 00
Ambalaj Şekli	Packing Type	Kutu - Box	Kutu - Box
Adet / m	Quantity / m	156 m	156 m
Ağırlık	Weight	19,695 kg	19,695 kg
m ³ /	Volume	0,07644	0,06240

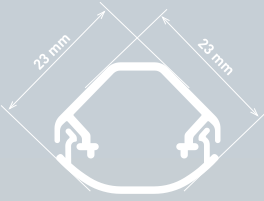

**23x23****Tavan Köşe Kanalı**
Ceiling Corner Trunking**MEKS** Serisi Series

Ürün Kodu	Product Code	001 002 023023 20 00
Ambalaj Şekli	Packing Type	Kutu - Box
Adet / m	Quantity / m	120 m
Ağırlık	Weight	23,940 kg
m ³ /	Volume	0,07536

AKSESUARLAR - ACCESSORIES

Kod Code	Ürün Product	Adet Quantity	Ağırlık Weight	m ³ Volume
 001 041 023023 00 00	T Köşe T Corner	60	0,258 kg	0,00293
 001 042 023023 00 00	90° L Köşe 90° L Corner	60	0,252 kg	0,00293
 001 043 023023 00 00	Ek Parça Connector	100	0,150 kg	0,00131
 001 044 023023 00 00	Uç Tapa Blind Cap	100	0,180 kg	0,00139

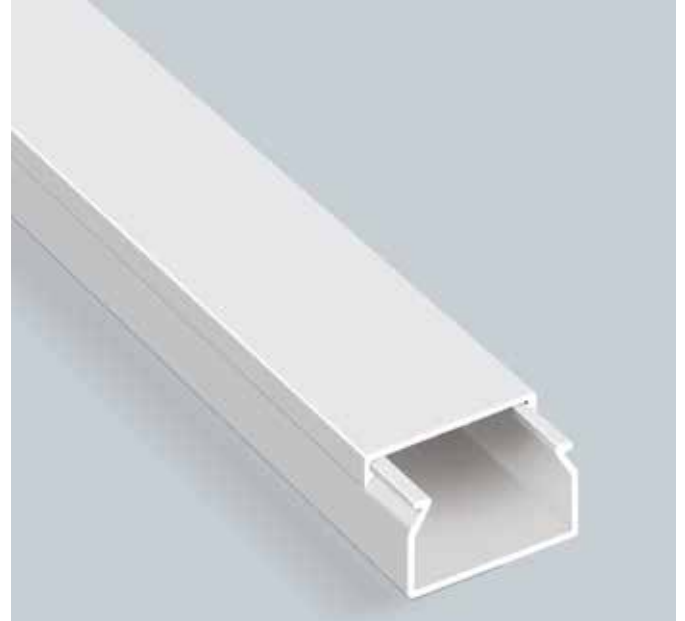
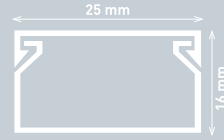
**25x16****EKO** Serisi Series**MEKS** Serisi Series**CANALEX** Serisi Series

Ürün Kodu	Product Code	001 014 025016 20 00	001 002 025016 20 00	001 156 025016 20 00
Ambalaj Şekli	Packing Type	Kutu - Box	Kutu - Box	Kutu - Box
Adet / m	Quantity / m	150 m	150 m	150 m
Ağırlık	Weight	20,505 kg	20,660 kg	18,110 kg
m ³ /	Volume	0,08235	0,08235	0,08235

AKSESUARLAR - ACCESSORIES

Kod Code	Ürün Product	Adet Quantity	Ağırlık Weight	m ³ Volume
 001 039 025016 00 00	İç Köşe Internal Corner	40	0,390 kg	0,00293
 001 040 025016 00 00	Dış Köşe External Corner	40	0,484 kg	0,00293
 001 041 025016 00 00	T Köşe T Corner	30	0,395 kg	0,00293
 001 042 025016 00 00	90° L Köşe 90° L Corner	50	0,490 kg	0,00293
 001 043 025016 00 00	Ek Parça Connector	100	0,260 kg	0,00139
 001 044 025016 00 00	Uç Tapa Blind Cap	100	0,240 kg	0,00139
 001 047 017421 00 00	PM Kasası 1 li Socket Assembly Frame Single	12	1,290 kg	0,00600



25x25

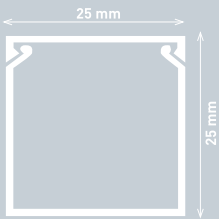

		EKO Serisi Series	MEKS Serisi Series	CANALEX Serisi Series
Ürün Kodu	Product Code	001 014 025025 20 00	001 002 025025 20 00	001 156 025025 20 00
Ambalaj Şekli	Packing Type	Kutu - Box	Kutu - Box	Kutu - Box
Adet / m	Quantity / m	100 m	100 m	100 m
Ağırlık	Weight	18,760 kg	18,760 kg	17,360 kg
m ³ /	Volume	0,08000	0,08000	0,07816

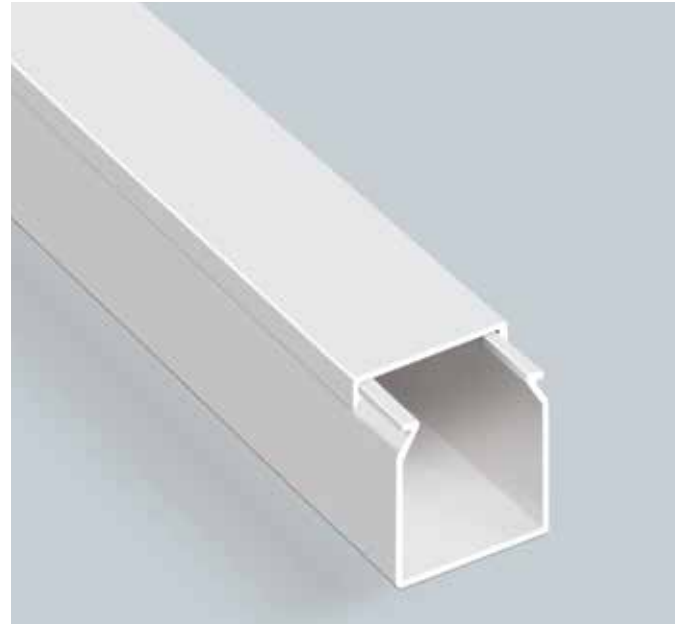

25x40

Aksesuarsız
Without Accessories

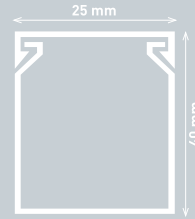

		EKO Serisi Series	MEKS Serisi Series
Ürün Kodu	Product Code	001 014 025040 20 00	001 002 025040 20 00
Ambalaj Şekli	Packing Type	Kutu - Box	Kutu - Box
Adet / m	Quantity / m	80 m	80 m
Ağırlık	Weight	24,843 kg	24,840 kg
m ³ /	Volume	0,09664	0,09664

AKSESUARLAR - ACCESSORIES

	Kod Code	Ürün Product	Adet Quantity	Ağırlık Weight	m ³ Volume
	001 039 025025 00 00	İç Köşe Internal Corner	40	0,424 kg	0,00293
	001 040 025025 00 00	Dış Köşe External Corner	40	0,516 kg	0,00293
	001 041 025025 00 00	T Köşe T Corner	24	0,405 kg	0,00293
	001 042 025025 00 00	90° L Köşe 90° L Corner	40	0,516 kg	0,00293
	001 043 025025 00 00	Ek Parça Connector	50	0,184 kg	0,00139
	001 044 025025 00 00	Uç Tapa Blind Cap	100	0,310 kg	0,00139
	001 047 017421 00 00	PM Kasası 1'li Socket Assembly Frame Single	12	1,290 kg	0,00600



**30x10****Bölmeli**
Partitioned

		EKO Serisi Series	MEKS Serisi Series
Ürün Kodu	Product Code	001 014 930010 20 00	001 002 930010 20 00
Ambalaj Şekli	Packing Type	Kutu - Box	Kutu - Box
Adet / m	Quantity / m	140 m	140 m
Ağırlık	Weight	18,410 kg	18,410 kg
m ³ /	Volume	0,05040	0,05040

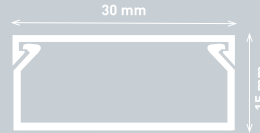
**30x15****Aksesuarsız**
Without Accessories

		EKO Serisi Series	MEKS Serisi Series
Ürün Kodu	Product Code	001 014 030015 20 00	001 002 030015 20 00
Ambalaj Şekli	Packing Type	Kutu - Box	Kutu - Box
Adet / m	Quantity / m	140 m	140 m
Ağırlık	Weight	21,000 kg	21,000 kg
m ³ /	Volume	0,08862	0,08862

AKSESUARLAR - ACCESSORIES

	Kod Code	Ürün Product	Adet Quantity	Ağırlık Weight	m ³ Volume
	001 039 030010 00 00	İç Köşe Internal Corner	50	0,425 kg	0,00293
	001 040 030010 00 00	Dış Köşe External Corner	50	0,490 kg	0,00293
	001 041 030010 00 00	T Köşe T Corner	50	0,595 kg	0,00293
	001 042 030010 00 00	90° L Köşe 90° L Corner	50	0,441 kg	0,00295
	001 043 030025 00 00	Ek Parça Connector	100	0,340 kg	0,00293
	001 044 030025 00 00	Uç Tapa Blind Cap	100	0,405 kg	0,00140





30x16



		EKO Serisi Series	MEKS Serisi Series	CANALEX Serisi Series
Ürün Kodu	Product Code	001 014 030016 20 00	001 002 030016 20 00	001 156 030016 20 00
Ambalaj Şekli	Packing Type	Kutu - Box	Kutu - Box	Kutu - Box
Adet / m	Quantity / m	140 m	140 m	140 m
Ağırlık	Weight	23,282 kg	22,862 kg	20,720 kg
m ³ /	Volume	0,07532	0,07532	0,07532

AKSESUARLAR - ACCESSORIES

Kod Code	Ürün Product	Adet Quantity	Ağırlık Weight	m ³ Volume
001 039 030016 00 00	İç Köşe Internal Corner	35	0,380 kg	0,00293
001 040 030016 00 00	Dış Köşe External Corner	48	0,605 kg	0,00293
001 041 030016 00 00	T Köşe T Corner	40	0,565 kg	0,00293
001 042 030016 00 00	90° L Köşe 90° L Corner	50	0,535 kg	0,00293
001 043 030025 00 00	Ek Parça Connector	100	0,340 kg	0,00293
001 044 030025 00 00	Uç Tapa Blind Cap	100	0,405 kg	0,00140
001 047 017421 00 00	PM Kasası 1'li Socket Assembly Frame Single	12	1,290 kg	0,00600



30x16

Bölmeli
Partitioned

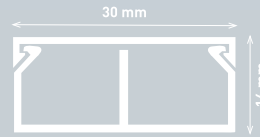

		EKO Serisi Series	MEKS Serisi Series
Ürün Kodu	Product Code	001 014 930016 20 00	001 002 930016 20 00
Ambalaj Şekli	Packing Type	Kutu - Box	Kutu - Box
Adet / m	Quantity / m	140 m	140 m
Ağırlık	Weight	22,860 kg	22,860 kg
m ³ /	Volume	0,08400	0,08400

AKSESUARLAR - ACCESSORIES

Kod Code	Ürün Product	Adet Quantity	Ağırlık Weight	m ³ Volume
001 039 030016 00 00	İç Köşe Internal Corner	35	0,380 kg	0,00293
001 040 030016 00 00	Dış Köşe External Corner	48	0,605 kg	0,00293
001 041 030016 00 00	T Köşe T Corner	40	0,565 kg	0,00293
001 042 030016 00 00	90° L Köşe 90° L Corner	50	0,535 kg	0,00293
001 043 030025 00 00	Ek Parça Connector	100	0,340 kg	0,00293
001 044 030025 00 00	Uç Tapa Blind Cap	100	0,405 kg	0,00140
001 047 017421 00 00	PM Kasası 1'li Socket Assembly Frame Single	12	1,290 kg	0,00600



30x25



		EKO Serisi Series	MEKS Serisi Series
Ürün Kodu	Product Code	001 014 030025 20 00	001 002 030025 20 00
Ambalaj Şekli	Packing Type	Kutu - Box	Kutu - Box
Adet / m	Quantity / m	80 m	80 m
Ağırlık	Weight	15,860 kg	15,860 kg
m ³ /	Volume	0,07256	0,07256

AKSESUARLAR - ACCESSORIES

	Kod Code	Ürün Product	Adet Quantity	Ağırlık Weight	m ³ Volume
	001 039 030025 00 00	İç Köşe Internal Corner	32	0,470 kg	0,00293
	001 040 030025 00 00	Dış Köşe External Corner	30	0,530 kg	0,00293
	001 041 030025 00 00	T Köşe T Corner	24	0,445 kg	0,00293
	001 042 030025 00 00	90° L Köşe 90° L Corner	30	0,430 kg	0,00293
	001 043 030025 00 00	Ek Parça Connector	100	0,340 kg	0,00293
	001 044 030025 00 00	Uç Tapa Blind Cap	100	0,405 kg	0,00140
	001 047 017421 00 00	PM Kasası 1'li Socket Assembly Frame Single	12	1,290 kg	0,00600

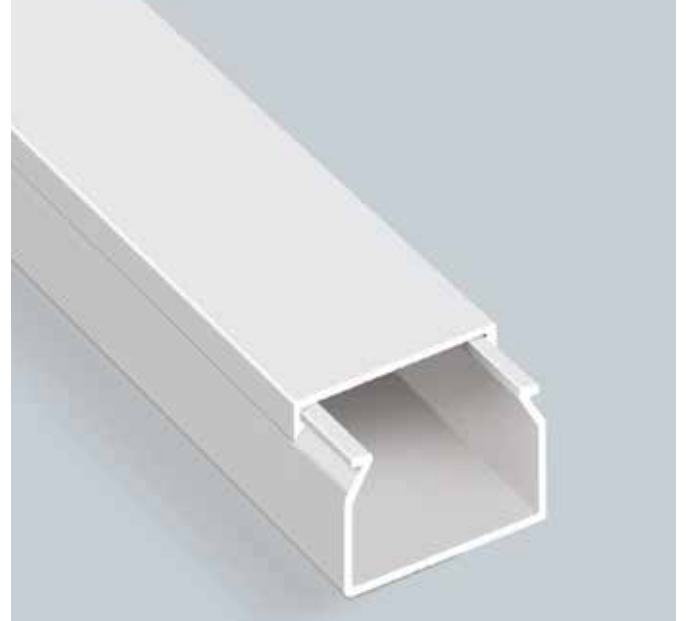

30x30

Aksesuarsız
Without Accessories

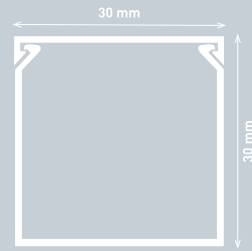

		EKO Serisi Series	MEKS Serisi Series
Ürün Kodu	Product Code	001 014 030030 20 00	001 002 030030 20 00
Ambalaj Şekli	Packing Type	Kutu - Box	Kutu - Box
Adet / m	Quantity / m	80 m	80 m
Ağırlık	Weight	16,480 kg	16,480 kg
m ³ /	Volume	0,09272	0,09272





40x16



		EKO Serisi Series	MEKS Serisi Series	CANALEX Serisi Series
Ürün Kodu	Product Code	001 014 040016 20 00	001 002 040016 20 00	001 156 040016 20 00
Ambalaj Şekli	Packing Type	Kutu - Box	Kutu - Box	Kutu - Box
Adet / m	Quantity / m	100 m	100 m	100 m
Ağırlık	Weight	18,900 kg	18,900 kg	17,660 kg
m ³ /	Volume	0,08095	0,08095	0,08095

AKSESUARLAR - ACCESSORIES

Kod Code	Ürün Product	Adet Quantity	Ağırlık Weight	m ³ Volume
001 039 040016 00 00	İç Köşe Internal Corner	32	0,432 kg	0,00293
001 040 040016 00 00	Dış Köşe External Corner	30	0,519 kg	0,00293
001 041 040016 00 00	T Köşe T Corner	24	0,461 kg	0,00293
001 042 040016 00 00	90° L Köşe 90° L Corner	34	0,524 kg	0,00293
001 043 040040 00 00	Ek Parça Connector	100	0,722 kg	0,01011
001 044 040040 00 00	Uç Tapa Blind Cap	25	0,210 kg	0,00139
001 047 017421 00 00	PM Kasası 1'li Socket Assembly Frame Single	12	1,290 kg	0,00600

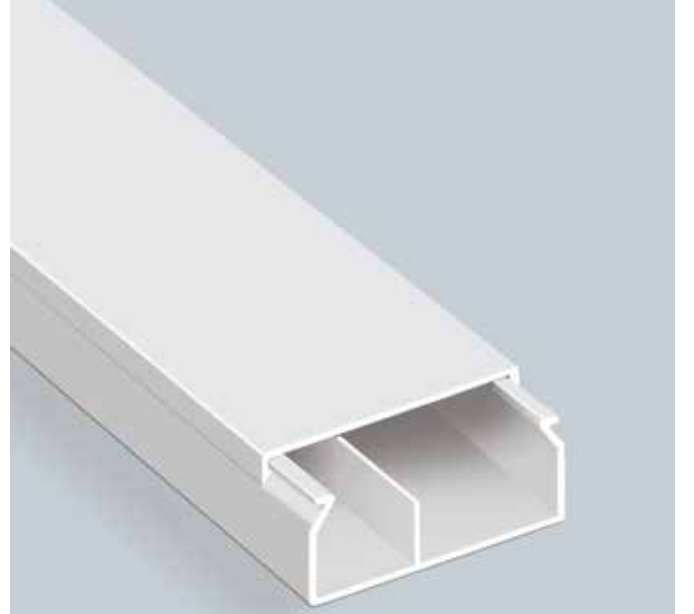

40x16

Bölmeli
Partitioned

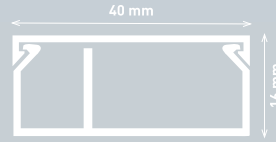

		EKO Serisi Series	MEKS Serisi Series
Ürün Kodu	Product Code	001 014 940016 20 00	001 002 940016 20 00
Ambalaj Şekli	Packing Type	Kutu - Box	Kutu - Box
Adet / m	Quantity / m	100 m	100 m
Ağırlık	Weight	23,160 kg	23,160 kg
m ³ /	Volume	0,08000	0,08000

AKSESUARLAR - ACCESSORIES

Kod Code	Ürün Product	Adet Quantity	Ağırlık Weight	m ³ Volume
001 039 040016 00 00	İç Köşe Internal Corner	32	0,432 kg	0,00293
001 040 040016 00 00	Dış Köşe External Corner	30	0,519 kg	0,00293
001 041 040016 00 00	T Köşe T Corner	24	0,461 kg	0,00293
001 042 040016 00 00	90° L Köşe 90° L Corner	34	0,524 kg	0,00293
001 043 040040 00 00	Ek Parça Connector	100	0,722 kg	0,01011
001 044 040040 00 00	Uç Tapa Blind Cap	25	0,210 kg	0,00139
001 047 017421 00 00	PM Kasası 1'li Socket Assembly Frame Single	12	1,290 kg	0,00600

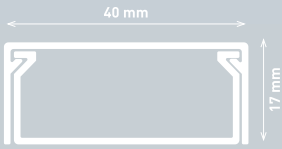
**40x17****Tam Kapaklı - Full Cover**
Aksesuarsız - Without Accessories**MEKS** Serisi

Ürün Kodu	Product Code	001 002 040017 20 00
Ambalaj Şekli	Packing Type	Kutu - Box
Adet / m	Quantity / m	100 m
Ağırlık	Weight	26,160 kg
m ³ /	Volume	0,08090

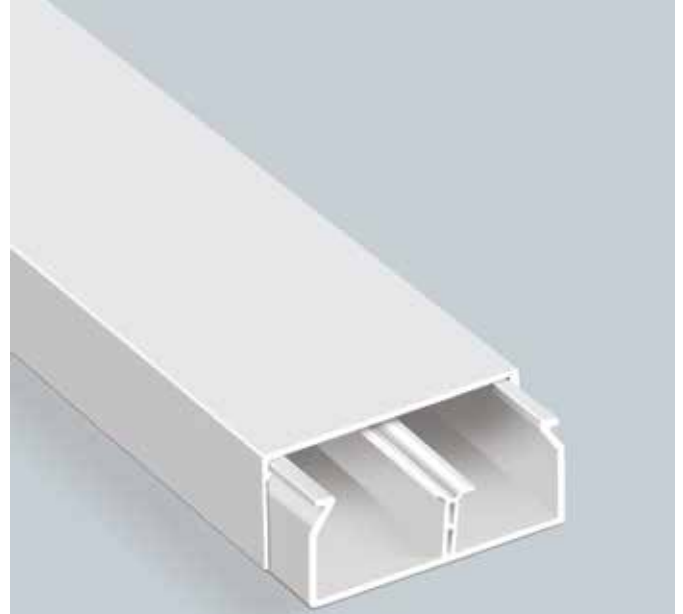
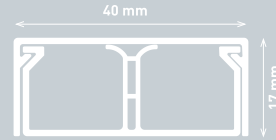
**40x17****Tam Kapaklı Bölmeli**
Full Cover and Partitioned
Aksesuarsız
Without Accessories**MEKS** Serisi

Ürün Kodu	Product Code	001 002 940017 20 00
Ambalaj Şekli	Packing Type	Kutu - Box
Adet / m	Quantity / m	100 m
Ağırlık	Weight	28,300 kg
m ³ /	Volume	0,08090



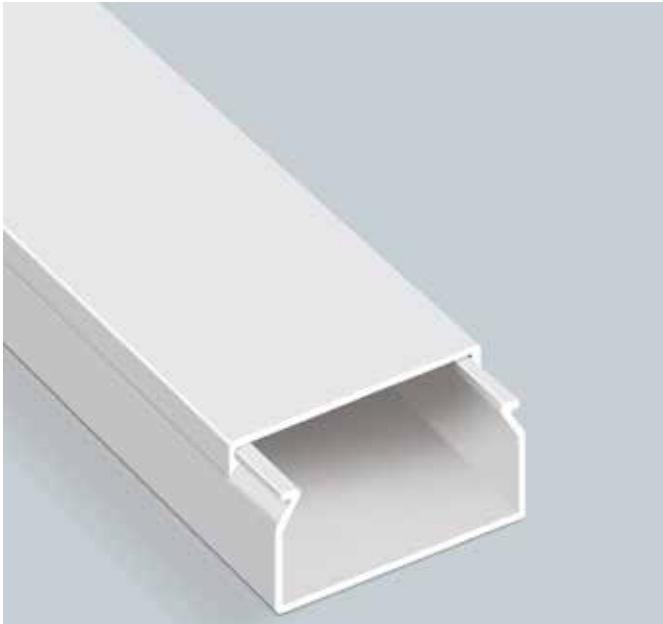

40x25

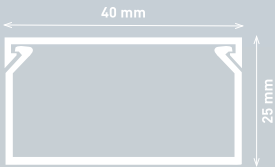

		EKO Serisi Series	MEKS Serisi Series	CANALEX Serisi Series
Ürün Kodu	Product Code	001 014 040025 20 00	001 002 040025 20 00	001 156 040025 20 00
Ambalaj Şekli	Packing Type	Kutu - Box	Kutu - Box	Kutu - Box
Adet / m	Quantity / m	80 m	80 m	80 m
Ağırlık	Weight	19,640 kg	18,840 kg	17,200 kg
m ³ /	Volume	0,09600	0,09600	0,09600

AKSESUARLAR - ACCESSORIES

	Kod Code	Ürün Product	Adet Quantity	Ağırlık Weight	m ³ Volume
	001 039 040025 00 00	İç Köşe Internal Corner	24	0,449 kg	0,00293
	001 040 040025 00 00	Dış Köşe External Corner	30	0,711 kg	0,00293
	001 041 040025 00 00	T Köşe T Corner	18	0,407 kg	0,00293
	001 042 040025 00 00	90° L Köşe 90° L Corner	24	0,432 kg	0,00293
	001 043 040040 00 00	Ek Parça Connector	100	0,722 kg	0,01011
	001 044 040040 00 00	Uç Tapa Blind Cap	25	0,210 kg	0,00139
	001 047 017421 00 00	PM Kasası 1'li Socket Assembly Frame Single	12	1,290 kg	0,00600

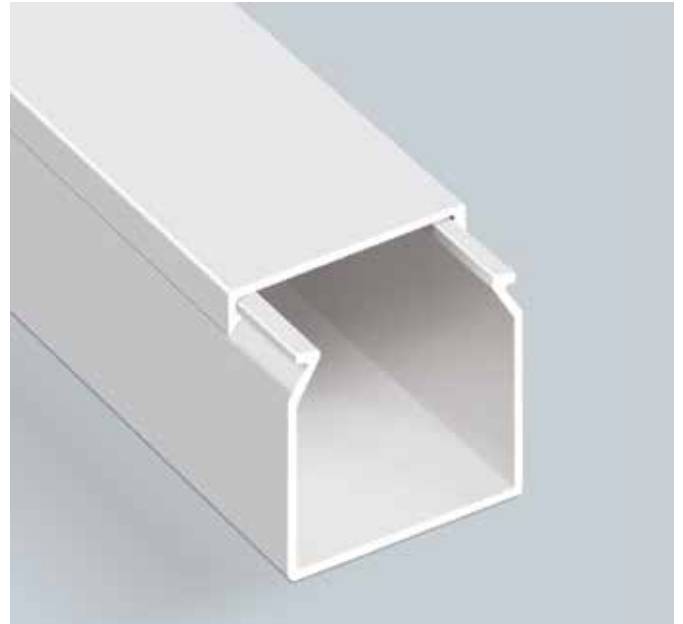

40x40

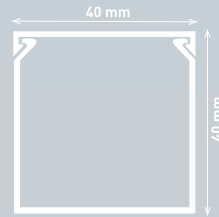

		EKO Serisi Series	MEKS Serisi Series	CANALEX Serisi Series
Ürün Kodu	Product Code	001 014 040040 20 00	001 002 040040 20 00	001 156 040040 20 00
Ambalaj Şekli	Packing Type	Kutu - Box	Kutu - Box	Kutu - Box
Adet / m	Quantity / m	50 m	50 m	50 m
Ağırlık	Weight	15,500 kg	15,500 kg	14,150 kg
m ³ /	Volume	0,10230	0,10230	0,10230

AKSESUARLAR - ACCESSORIES

	Kod Code	Ürün Product	Adet Quantity	Ağırlık Weight	m ³ Volume
	001 039 040040 00 00	İç Köşe Internal Corner	18	0,504 kg	0,00282
	001 040 040040 00 00	Dış Köşe External Corner	10	0,320 kg	0,00282
	001 041 040040 00 00	T Köşe T Corner	48	1,415 kg	0,01011
	001 042 040040 00 00	90° L Köşe 90° L Corner	60	1,488 kg	0,01011
	001 043 040040 00 00	Ek Parça Connector	100	0,722 kg	0,01011
	001 044 040040 00 00	Uç Tapa Blind Cap	25	0,210 kg	0,00139

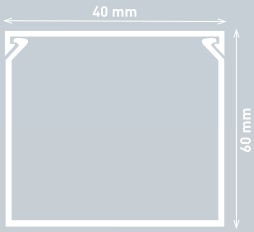
**40x60****Aksesuarsız**
Without Accessories**EKO** Serisi Series**MEKS** Serisi Series

Ürün Kodu	Product Code	001 014 040060 20 00	001 002 040060 20 00
Ambalaj Şekli	Packing Type	Kutu - Box	Kutu - Box
Adet / m	Quantity / m	40 m	40 m
Ağırlık	Weight	21,518 kg	21,520 kg
m ³ /	Volume	0,11216	0,11216

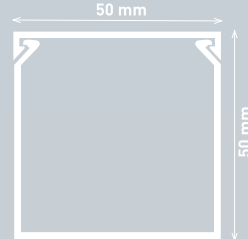
**50x50****Aksesuarsız**
Without Accessories**EKO** Serisi Series

Ürün Kodu	Product Code	001 014 050050 20 00
Ambalaj Şekli	Packing Type	Kutu - Box
Adet / m	Quantity / m	30 m
Ağırlık	Weight	14,052 kg
m ³ /	Volume	0,09663



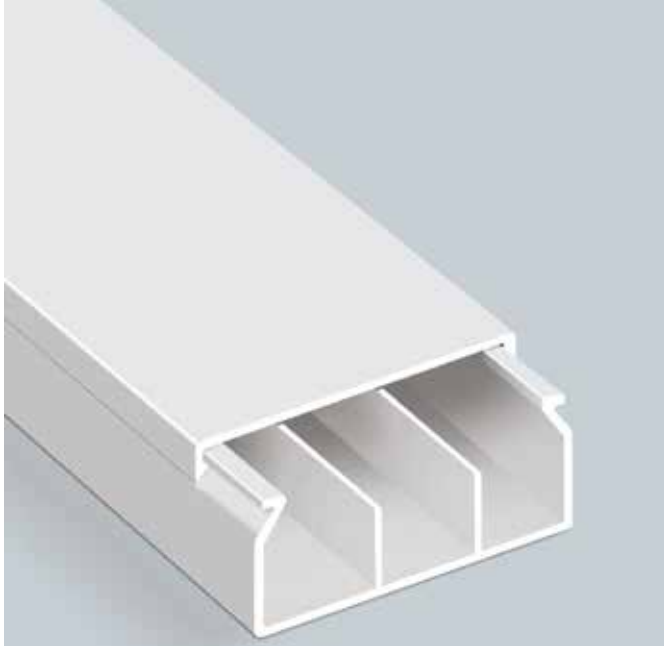

60x25

Bölmeli
Partitioned

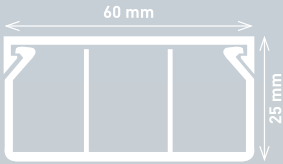

EKO Serisi Series

MEKS Serisi Series

Ürün Kodu	Product Code	001 014 690025 20 00	001 002 690025 20 00
Ambalaj Şekli	Packing Type	Kutu - Box	Kutu - Box
Adet / m	Quantity / m	40 m	40 m
Ağırlık	Weight	17,140 kg	17,140 kg
m ³ /	Volume	0,07264	0,07264

AKSESUARLAR - ACCESSORIES

Kod Code	Ürün Product	Adet Quantity	Ağırlık Weight	m ³ Volume
001 039 060025 00 00	İç Köşe Internal Corner	48	1,192 kg	0,01011
001 040 060025 00 00	Dış Köşe External Corner	72	1,781 kg	0,01011
001 041 060025 00 00	T Köşe T Corner	40	1,250 kg	0,01011
001 042 060025 00 00	90° L Köşe 90° L Corner	60	2,190 kg	0,01008
001 043 060060 00 00	Ek Parça Connector	25	0,372 kg	0,00293
001 044 060025 00 00	Uç Tapa Blind Cap	50	0,510 kg	0,00293
001 047 017421 00 00	PM Kasası 1'li Socket Assembly Frame Single	12	1,290 kg	0,00600



60x40

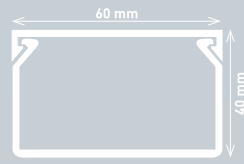

EKO Serisi Series

MEKS Serisi Series

CANALEX Serisi Series

Ürün Kodu	Product Code	001 014 060040 20 00	001 002 060040 20 00	001 156 060040 20 00
Ambalaj Şekli	Packing Type	Kutu - Box	Kutu - Box	Kutu - Box
Adet / m	Quantity / m	40 m	40 m	40 m
Ağırlık	Weight	16,400 kg	16,400 kg	15,518 kg
m ³ /	Volume	0,11200	0,11200	0,11200

AKSESUARLAR - ACCESSORIES

Kod Code	Ürün Product	Adet Quantity	Ağırlık Weight	m ³ Volume
001 039 060040 00 00	İç Köşe Internal Corner	26	1,160 kg	0,01011
001 040 060040 00 00	Dış Köşe External Corner	32	1,225 kg	0,01011
001 041 060040 00 00	T Köşe T Corner	32	1,180 kg	0,01011
001 042 060040 00 00	90° L Köşe 90° L Corner	40	1,375 kg	0,01011
001 043 060060 00 00	Ek Parça Connector	25	0,372 kg	0,00293
001 044 060040 00 00	Uç Tapa Blind Cap	30	0,975 kg	0,00294

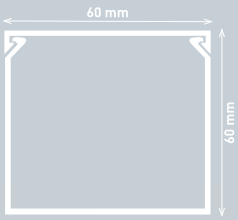
**60x60**

EKO Serisi Series	MEKS Serisi Series	CANALEX Serisi Series
-----------------------------	------------------------------	---------------------------------

Ürün Kodu	Product Code	001 014 060060 20 00	001 002 060060 20 00	001 156 060060 20 00
Ambalaj Şekli	Packing Type	Kutu - Box	Kutu - Box	Kutu - Box
Adet / m	Quantity / m	32 m	32 m	32 m
Ağırlık	Weight	20,445 kg	20,445 kg	18,717 kg
m ³ /	Volume	0,13591	0,13591	0,13591

AKSESUARLAR - ACCESSORIES

	Kod Code	Ürün Product	Adet Quantity	Ağırlık Weight	m ³ Volume
	001 039 060060 01 00	Hareketli İç Köşe Internal Corner Live	16	1,123 kg	0,01011
	001 040 060060 01 00	Hareketli Dış Köşe External Corner Live	16	1,361 kg	0,01011
	001 041 060060 00 00	T Köşe T Corner	20	1,406 kg	0,01011
	001 042 060060 00 00	90° L Köşe 90° L Corner	24	1,691 kg	0,01011
	001 043 060060 00 00	Ek Parça Connector	25	0,372 kg	0,00293
	001 044 060060 00 00	Uç Tapa Blind Cap	30	0,975 kg	0,00294

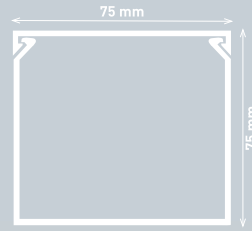
**75x75****Aksesuarsız**
Without Accessories**EKO**
Serisi Series

Ürün Kodu	Product Code	001 014 075075 20 00
Ambalaj Şekli	Packing Type	Kutu - Box
Adet / m	Quantity / m	28 m
Ağırlık	Weight	25,153 kg
m ³ /	Volume	0,17357



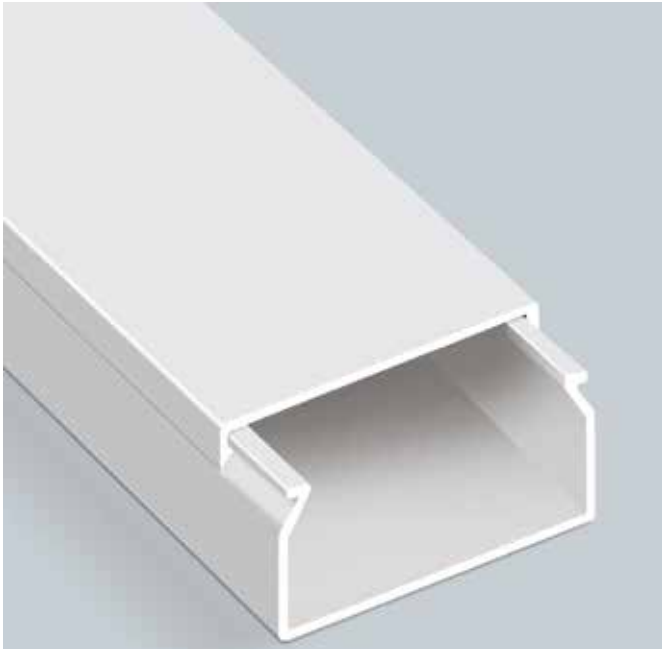

80x40

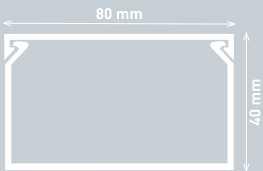

		EKO Serisi Series	MEKS Serisi Series	CANALEX Serisi Series
Ürün Kodu	Product Code	001 014 080040 20 00	001 002 080040 20 00	001 156 080040 20 00
Ambalaj Şekli	Packing Type	Kutu - Box	Kutu - Box	Kutu - Box
Adet / m	Quantity / m	30 m	30 m	30 m
Ağırlık	Weight	19,518 kg	19,518 kg	17,118 kg
m ³ /	Volume	0,11217	0,11217	0,11217

AKSESUARLAR - ACCESSORIES

	Kod Code	Ürün Product	Adet Quantity	Ağırlık Weight	m ³ Volume
	001 039 080040 00 00	İç Köşe Internal Corner	18	1,107 kg	0,01011
	001 040 080040 00 00	Dış Köşe External Corner	8	0,839 kg	0,00653
	001 041 080040 00 00	T Köşe T Corner	12	1,194 kg	0,01011
	001 042 080040 00 00	90° L Köşe 90° L Corner	16	1,386 kg	0,01011
	001 043 080040 00 00	Ek Parça Connector	100	1,183 kg	0,00970
	001 044 080040 00 00	Uç Tapa Blind Cap	60	0,887 kg	0,00293

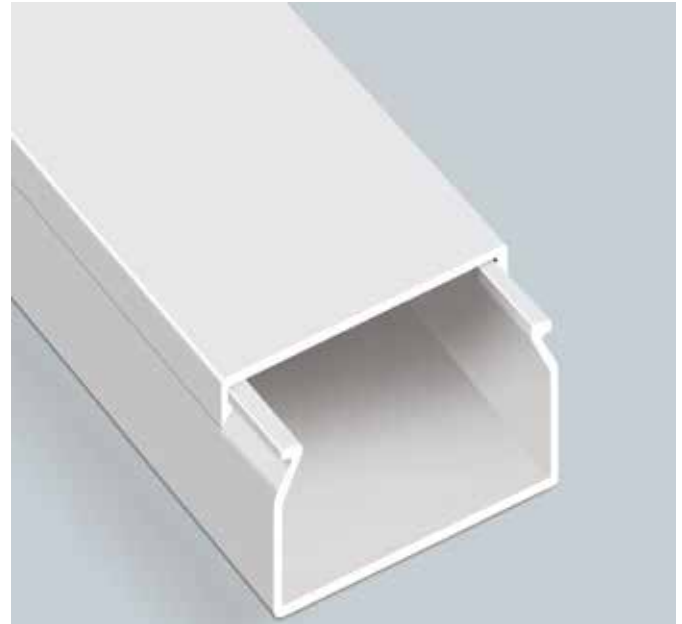

80x60

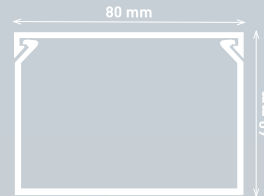

		EKO Serisi Series	MEKS Serisi Series	CANALEX Serisi Series
Ürün Kodu	Product Code	001 014 080060 20 00	001 002 080060 20 00	001 156 080060 20 00
Ambalaj Şekli	Packing Type	Kutu - Box	Kutu - Box	Kutu - Box
Adet / m	Quantity / m	24 m	24 m	24 m
Ağırlık	Weight	17,232 kg	17,232 kg	16,157 kg
m ³ /	Volume	0,13591	0,13591	0,13591

AKSESUARLAR - ACCESSORIES

	Kod Code	Ürün Product	Adet Quantity	Ağırlık Weight	m ³ Volume
	001 039 080060 00 00	İç Köşe Internal Corner	12	0,980 kg	0,01011
	001 040 080060 00 00	Dış Köşe External Corner	8	0,898 kg	0,00653
	001 041 080060 00 00	T Köşe T Corner	10	1,237 kg	0,01011
	001 042 080060 00 00	90° L Köşe 90° L Corner	12	1,287 kg	0,01010
	001 043 080060 00 00	Ek Parça Connector	80	1,131 kg	0,00976
	001 044 080060 00 00	Uç Tapa Blind Cap	48	0,944 kg	0,00293

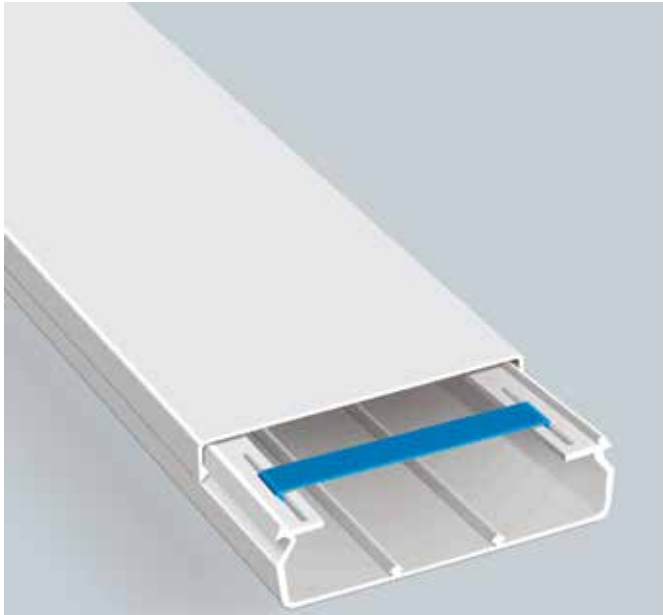
**100x36****Kilitleme Aparatlı**
With Locking Apparatus**MEKS** Serisi Series

Ürün Kodu	Product Code	001 002 100036 20 00
Ambalaj Şekli	Packing Type	Kutu - Box
Adet / m	Quantity / m	30 m
Ağırlık	Weight	29,897 kg
m ³ /	Volume	0,13722

AKSESUARLAR - ACCESSORIES

Kod Code	Ürün Product	Adet Quantity	Ağırlık Weight	m ³ Volume
 001 013 100036 20 00	Ara Bölme Partition	200 m	20,400 kg	0,05040
 001 039 100036 00 00	İç Köşe Internal Corner	8	0,733 kg	0,01011
 001 039 100040 01 00	İç Köşe Hareketli Internal Corner Live	16	1,152 kg	0,01376
 001 040 100040 00 00	Dış Köşe External Corner	8	0,905 kg	0,00653
 001 040 100036 01 00	Dış Köşe Hareketli External Corner Live	10	0,959 kg	0,00817
 001 041 100036 00 00	T Köşe T Corner	12	1,252 kg	0,01011
 001 042 100036 00 00	90° L Köşe 90° L Corner	12	1,191 kg	0,01011
 001 043 100060 00 00	Ek Parça Connector	100	0,966 kg	0,01011
 001 044 100060 00 00	Uç Tapa Blind Cap	20	0,529 kg	0,00293
 001 050 030004 00 00	Kilitleme Aparatı Locking Apparatus	100	0,280 kg	0,00100

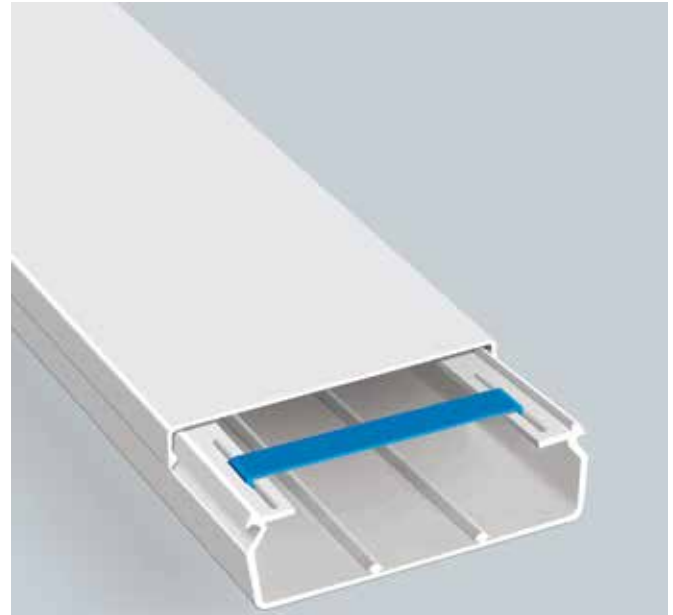
**100x40****Kilitleme Aparatlı**
With Locking Apparatus**EKO** Serisi Series**MEKS** Serisi Series**CANALEX** Serisi Series

Ürün Kodu	Product Code	001 014 100040 20 00	001 002 100040 20 00	001 156 100040 20 00
Ambalaj Şekli	Packing Type	Kutu - Box	Kutu - Box	Kutu - Box
Adet / m	Quantity / m	24 m	24 m	24 m
Ağırlık	Weight	18,648 kg	21,918 kg	16,380 kg
m ³ /	Volume	0,11347	0,11347	0,11347

AKSESUARLAR - ACCESSORIES

Kod Code	Ürün Product	Adet Quantity	Ağırlık Weight	m ³ Volume
 001 013 100040 20 00	Ara Bölme Partition	200 m	21,050 kg	0,05040
 001 039 100040 00 00	İç Köşe Internal Corner	8	0,795 kg	0,01011
 001 039 100040 01 00	İç Köşe Hareketli Internal Corner Live	16	1,152 kg	0,01376
 001 040 100040 00 00	Dış Köşe External Corner	8	0,905 kg	0,00653
 001 040 100040 01 00	Dış Köşe Hareketli External Corner Live	10	0,959 kg	0,00817
 001 041 100040 00 00	T Köşe T Corner	12	1,344 kg	0,01010
 001 042 100040 00 00	90° L Köşe 90° L Corner	12	1,233 kg	0,01011
 001 043 100060 00 00	Ek Parça Connector	100	0,966 kg	0,01011
 001 044 100060 00 00	Uç Tapa Blind Cap	20	0,529 kg	0,00293
 001 050 030004 00 00	Kilitleme Aparatı Locking Apparatus	100	0,280 kg	0,00100

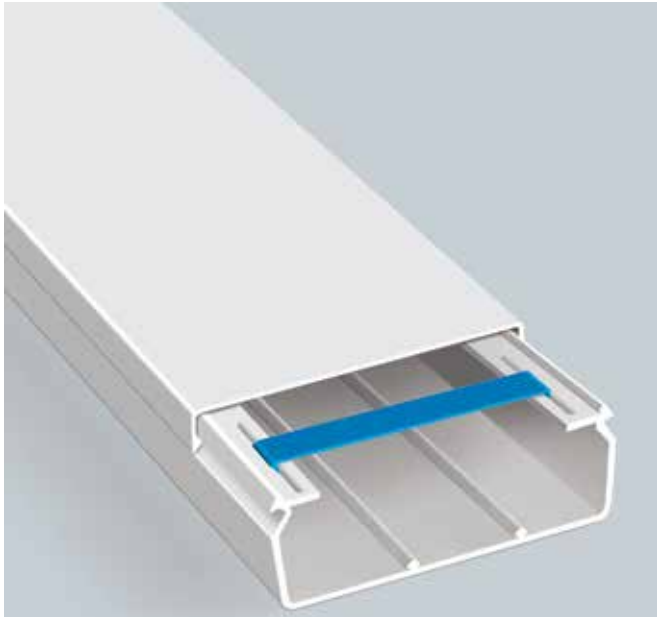

100x48

Kilitleme Aparatlı
With Locking Apparatus

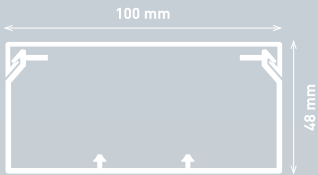

MEKS Serisi Series

Ürün Kodu	Product Code	001 002 100048 20 00
Ambalaj Şekli	Packing Type	Kutu - Box
Adet / m	Quantity / m	24 m
Ağırlık	Weight	25,757 kg
m ² /	Volume	0,13591

AKSESUARLAR - ACCESSORIES

Kod Code	Ürün Product	Adet Quantity	Ağırlık Weight	m ³ Volume
001 013 100048 20 00	Ara Bölme Partition	150 m	19,605 kg	0,07500
001 039 100048 00 00	İç Köşe Internal Corner	8	0,915 kg	0,01011
001 039 100060 01 00	İç Köşe Hareketli Internal Corner Live	10	1,190 kg	0,01364
001 040 100048 00 00	Dış Köşe External Corner	8	0,918 kg	0,00653
001 040 100060 01 00	Dış Köşe Hareketli External Corner Live	10	1,120 kg	0,01011
001 041 100048 00 00	T Köşe T Corner	8	1,008 kg	0,01011
001 042 100048 00 00	90° L Köşe 90° L Corner	8	0,936 kg	0,01011
001 043 100060 00 00	Ek Parça Connector	100	0,966 kg	0,01011
001 044 100060 00 00	Uç Tapa Blind Cap	20	0,529 kg	0,00293
001 050 030004 00 00	Kilitleme Aparatı Locking Apparatus	100	0,280 kg	0,00100

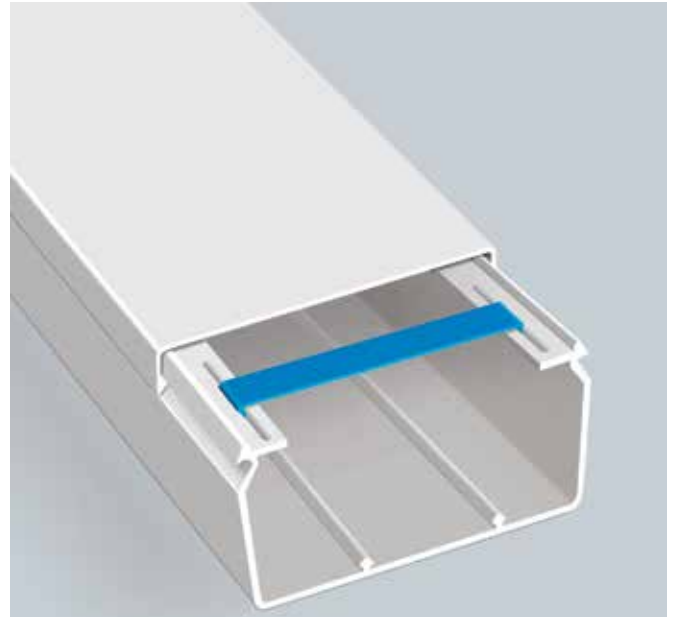

100x60

Kilitleme Aparatlı
With Locking Apparatus

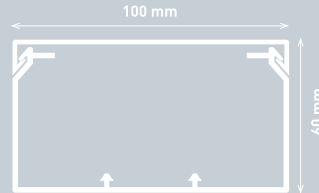

EKO Serisi Series

MEKS Serisi Series

CANALEX Serisi Series

Ürün Kodu	Product Code	001 014 100060 20 00	001 002 100060 20 00	001 156 100060 20 00
Ambalaj Şekli	Packing Type	Kutu - Box	Kutu - Box	Kutu - Box
Adet / m	Quantity / m	20 m	20 m	20 m
Ağırlık	Weight	19,700 kg	22,757 kg	18,557 kg
m ³ /	Volume	0,13591	0,13591	0,13591

AKSESUARLAR - ACCESSORIES

Kod Code	Ürün Product	Adet Quantity	Ağırlık Weight	m ³ Volume
001 013 100060 20 00	Ara Bölme Partition	130 m	19,360 kg	0,07956
001 039 100060 00 00	İç Köşe Internal Corner	8	0,969 kg	0,01011
001 039 100060 01 00	İç Köşe Hareketli Internal Corner Live	10	1,190 kg	0,01364
001 040 100060 00 00	Dış Köşe External Corner	8	0,988 kg	0,00653
001 040 100060 01 00	Dış Köşe Hareketli External Corner Live	10	1,120 kg	0,01011
001 041 100060 00 00	T Köşe T Corner	8	1,067 kg	0,01011
001 042 100060 00 00	90° L Köşe 90° L Corner	8	1,080 kg	0,01011
001 043 100060 00 00	Ek Parça Connector	100	0,966 kg	0,01011
001 044 100060 00 00	Uç Tapa Blind Cap	20	0,529 kg	0,00293
001 050 030004 00 00	Kilitleme Aparatı Locking Apparatus	100	0,280 kg	0,00100

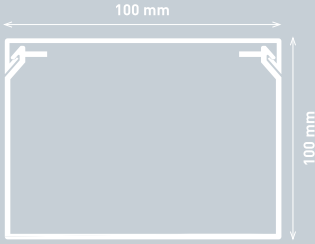
**100x100****Aksesuarsız**
Without Accessories**EKO** Serisi Series

Ürün Kodu	Product Code	001 014 100100 20 00
Ambalaj Şekli	Packing Type	Kutu - Box
Adet / m	Quantity / m	20 m
Ağırlık	Weight	29,017 kg
m ³ /	Volume	0,13590

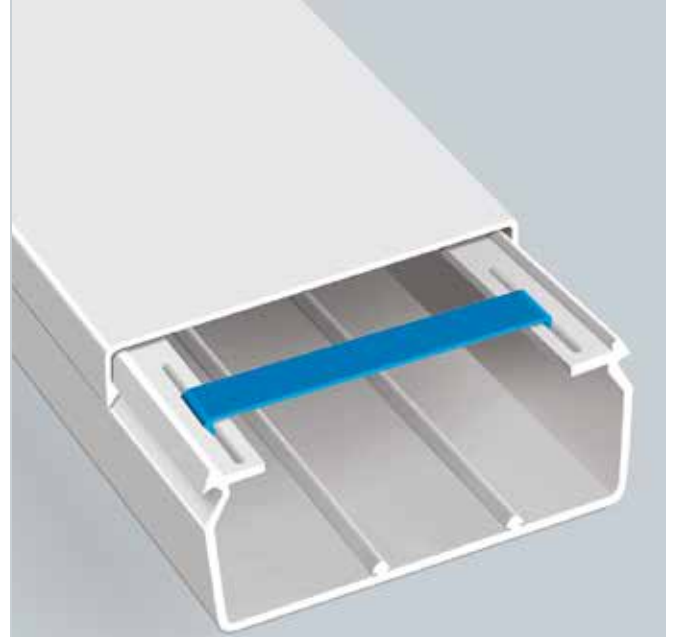
**120x60****Kilitleme Aparatlı**
With Locking Apparatus

		EKO Serisi Series	MEKS Serisi Series
Ürün Kodu	Product Code	001 014 120060 20 00	001 002 120060 20 00
Ambalaj Şekli	Packing Type	Kutu - Box	Kutu - Box
Adet / m	Quantity / m	16 m	16 m
Ağırlık	Weight	21,949 kg	21,949 kg
m ³ /	Volume	0,13590	0,13590

**AKSESUARLAR - ACCESSORIES**

	Kod Code	Ürün Product	Adet Quantity	Ağırlık Weight	m ³ Volume
	001 013 120060 20 00	Ara Bölme Partition	130 m	20,010 kg	0,07956
	001 039 120060 00 00	İç Köşe Internal Corner	8	0,939 kg	0,01011
	001 040 120060 00 00	Dış Köşe External Corner	8	0,860 kg	0,00653
	001 041 120060 00 00	T Köşe T Corner	8	1,050 kg	0,01011
	001 042 120060 00 00	90° L Köşe 90° L Corner	8	1,116 kg	0,01011
	001 043 120060 00 00	Ek Parça Connector	50	1,229 kg	0,01011
	001 044 120060 00 00	Uç Tapa Blind Cap	20	0,612 kg	0,00293
	001 050 030004 00 00	Kilitleme Aparatı Locking Apparatus			

DIŐTAN KAPAKLI 100'LÜK SERİ PRİZ MONTAJ SETLERİ

External Cover 100 Series Plug Socket Assembly Sets

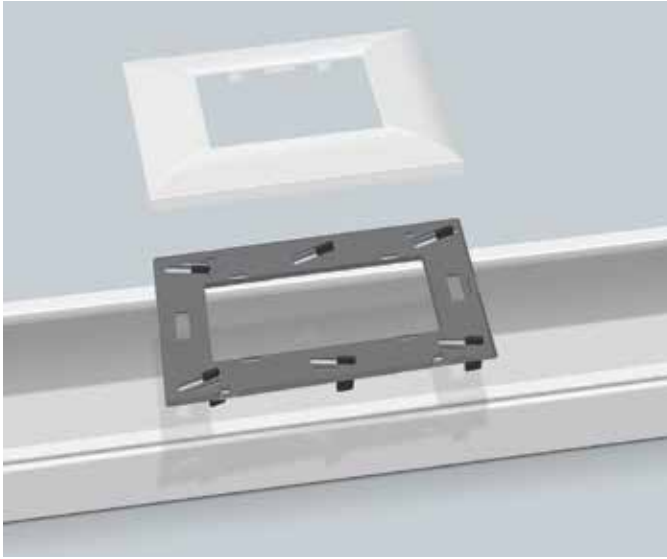

45x45 Tekli Çerçeve Single Frame



Ürün Kodu	Product Code	001 047 040001 00 00
Ambalaj Şekli	Packing Type	Kutu - Box
Adet / m	Quantity / m	20 ad.
Ağırlık	Weight	1,319 kg
m ³ /	Volume	0,00628

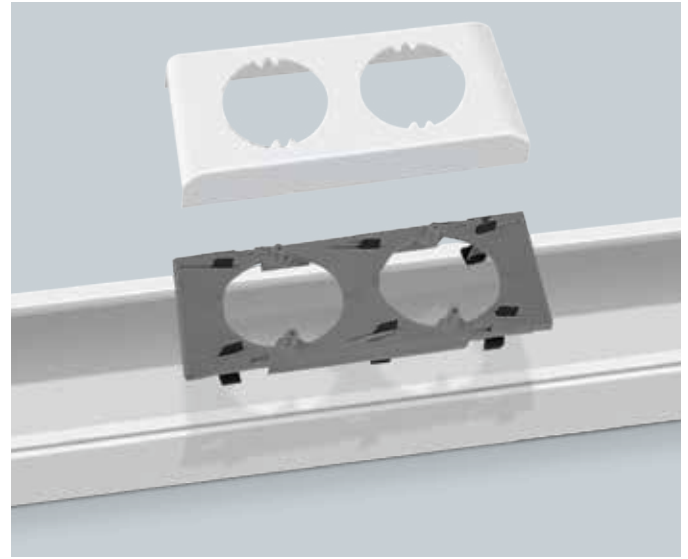

55x55 Tekli Çerçeve Single Frame



Ürün Kodu	Product Code	001 047 020001 00 00
Ambalaj Şekli	Packing Type	Kutu - Box
Adet / m	Quantity / m	20 ad.
Ağırlık	Weight	1,400 kg
m ³ /	Volume	0,00816

45x45 İkili Çerçeve Double Frame



Ürün Kodu	Product Code	001 047 040002 00 00
Ambalaj Şekli	Packing Type	Kutu - Box
Adet / m	Quantity / m	14 ad.
Ağırlık	Weight	1,260 kg
m ³ /	Volume	0,00627

55x55 İkili Çerçeve Double Frame



Ürün Kodu	Product Code	001 047 020002 00 00
Ambalaj Şekli	Packing Type	Kutu - Box
Adet / m	Quantity / m	14 ad.
Ağırlık	Weight	1,723 kg
m ³ /	Volume	0,00816

45x45 Üçlü Çerçeve Triple Frame



Ürün Kodu	Product Code	001 047 040003 00 00
Ambalaj Şekli	Packing Type	Kutu - Box
Adet / m	Quantity / m	12 ad.
Ağırlık	Weight	1,366 kg
m ³ /	Volume	0,00721

55x55 Üçlü Çerçeve Triple Frame



Ürün Kodu	Product Code	001 047 020003 00 00
Ambalaj Şekli	Packing Type	Kutu - Box
Adet / m	Quantity / m	10 ad.
Ağırlık	Weight	1,750 kg
m ³ /	Volume	0,00800

45x45 Dörtlü Çerçeve Quartet Frame



Ürün Kodu	Product Code	001 047 040004 00 00
Ambalaj Şekli	Packing Type	Kutu - Box
Adet / m	Quantity / m	10 ad.
Ağırlık	Weight	1,300 kg
m ³ /	Volume	0,00658



45x22.5 Data Priz Kapağı

45x22.5 Data Socket Frame

888 049 050012



Data Konnektörü 1x8 CAT6

Data Connector 1x8 CAT 6

888 049 050032



Kanal Kilitleme Aparatı

It prevents stretching which could occur in time

001 050 030004 00 00

Kanalda zamanla oluşabilecek esnemelerin önüne geçer.

Prevents back last that could occur in the trunking.

İNGİLİZ NORMU PRİZ MONTAJ SETLERİ

BRITISH NORM PLUG SOCKET ASSEMBLY SETS



İngiliz Normu Tekli Priz Tabanı

British Norm Single
Socket Base

Ürün Kodu	Product Code	001 047 980001 00 00
Ambalaj Şekli	Packing Type	Kutu - Box
Adet / m	Quantity / m	200 ad.
Ağırlık m ³ /	Weight Volume	3,850 kg 0,04000



İngiliz Normu İkili Priz Tabanı

British Norm Double
Socket Base

Ürün Kodu	Product Code	001 047 980002 00 00
Ambalaj Şekli	Packing Type	Kutu - Box
Adet / m	Quantity / m	100 ad.
Ağırlık m ³ /	Weight Volume	2,480 kg 0,04000



İngiliz Normu İkili Yüksek Tip Priz Tabanı

British Norm
Double High Type
Socket Base

Ürün Kodu	Product Code	001 047 990002 00 00
Ambalaj Şekli	Packing Type	Kutu - Box
Adet / m	Quantity / m	94 ad.
Ağırlık m ³ /	Weight Volume	5,076 kg 0,03196



Sıvaaltı Anahtar Kasası (Kare Buat)

Flush Mounted
Switch Casing
(Square Junction Box)

Ürün Kodu	Product Code	001 166 000001 00 00
Ambalaj Şekli	Packing Type	Kutu - Box
Adet / m	Quantity / m	28 ad.
Ağırlık m ³ /	Weight Volume	1,176 kg 0,01120

Meksplus serisi içten kapaklı kanallar

Meksplus Series
Internal Cover
Cable Trunking

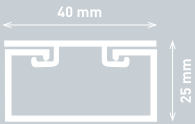

İçten Kapaklı
Intrinsic Cover

**40x25****Aksesuarsız**
Without Accessories**MEKPLUS** Serisi Series

Ürün Kodu	Product Code	001 003 040025 20 00
Ambalaj Şekli	Packing Type	Kutu - Box
Adet / m	Quantity / m	80 m
Ağırlık	Weight	26,843 kg
m ³ /	Volume	0,09592

**Koruma Bantlı**
Protecting Foil**100x37****EKO** Serisi - Series**MEKS** Serisi - Series**MEKPLUS** Serisi - Series

Ürün Kodu	Product Code	001 014 100037 20 00	001 002 100037 20 00	001 003 100037 20 00
Ambalaj Şekli	Packing Type	Kutu - Box	Kutu - Box	Kutu - Box
Adet / m	Quantity / m	30 m	30 m	30 m
Ağırlık	Weight	28,017 kg	29,067 kg	29,067 kg
m ³ /	Volume	0,13722	0,13722	0,13722

AKSESUARLAR - ACCESSORIES

	Kod Code	Ürün Product	Adet Quantity	Ağırlık Weight	m ³ Volume
	001 013 100037 20 00	Ara Bölme Partition	200 m	19,650 kg	0,05040
	001 039 100037 00 00	İç Köşe Internal Corner	12	0,807 kg	0,01011
	001 039 100050 01 00	İç Köşe Hareketli Internal Corner Live	12	1,020 kg	0,00960
	001 040 100037 00 00	Dış Köşe External Corner	8	0,723 kg	0,00653
	001 040 100050 01 00	Dış Köşe Hareketli External Corner Live	8	0,880 kg	0,00653
	001 041 100037 00 00	T Köşe T Corner	14	1,418 kg	0,01365
	001 042 100037 00 00	90° L Köşe 90° L Corner	14	1,400 kg	0,01365
	001 043 100050 00 00	Ek Parça Connector	100	1,590 kg	0,01000
	001 044 100037 00 00	Uç Tapa Blind Cap	50	0,790 kg	0,00293

Koruma Bantlı
Protecting Foil

Koruma Bantlı
Protecting Foil

100x41



100x50

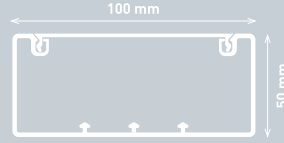

Kanal İçi Küp Buat
Duct Junction Cube



		MEKS Seri - Series	MEKSPLUS Seri - Series
Ürün Kodu	Product Code	001 002 100041 20 00	001 003 100041 20 00
Ambalaj Şekli	Packing Type	Kutu - Box	Kutu - Box
Adet / m	Quantity / m	24 m	24 m
Ağırlık	Weight	21,678 kg	21,678 kg
m ³ /	Volume	0,12221	0,12221

		CANALEX Seri - Series	EKO Seri - Series	MEKS Seri - Series	MEKSPLUS Seri - Series
Ürün Kodu	Product Code	001 156 100050 20 00	001 014 100050 20 00	001 002 100050 20 00	001 003 100050 20 00
Ambalaj Şekli	Packing Type	Kutu Box	Kutu Box	Kutu Box	Kutu Box
Adet / m	Quantity / m	20 m	20 m	20 m	20 m
Ağırlık	Weight	17,400 kg	17,880 kg	21,000 kg	21,000 kg
m ³ /	Volume	0,12600	0,12600	0,12600	0,12600

AKSESUARLAR - ACCESSORIES

Kod Code	Ürün Product	Adet Quantity	Ağırlık Weight	m ³ Volume
001 013 100040 20 00	Ara Bölme Partition	200 m	21,050 kg	0,05040
001 039 100050 00 00	İç Köşe Internal Corner	8	0,600 kg	0,01011
001 039 100050 01 00	İç Köşe Hareketli Internal Corner Live	12	1,020 kg	0,00960
001 040 100050 00 00	Dış Köşe External Corner	8	0,880 kg	0,00653
001 040 100050 01 00	Dış Köşe Hareketli External Corner Live	10	1,140 kg	0,01000
001 041 100050 00 00	T Köşe T Corner	10	1,000 kg	0,01364
001 042 100050 00 00	90° L Köşe 90° L Corner	10	1,012 kg	0,01364
001 043 100050 00 00	Ek Parça Connector	100	1,590 kg	0,01000
001 044 100050 00 00	Uç Tapa Blind Cap	40	0,736 kg	0,00400

AKSESUARLAR - ACCESSORIES

Kod Code	Ürün Product	Adet Quantity	Ağırlık Weight	m ³ Volume
001 013 100048 20 00	Ara Bölme Partition	150 m	19,605 kg	0,07500
001 039 100050 00 00	İç Köşe Internal Corner	8	0,600 kg	0,01011
001 039 100050 01 00	İç Köşe Hareketli Internal Corner Live	12	1,020 kg	0,00960
001 040 100050 00 00	Dış Köşe External Corner	8	0,880 kg	0,00653
001 040 100050 01 00	Dış Köşe Hareketli External Corner Live	10	1,140 kg	0,01000
001 041 100050 00 00	T Köşe T Corner	10	1,000 kg	0,01364
001 042 100050 00 00	90° L Köşe 90° L Corner	10	1,012 kg	0,01364
001 043 100050 00 00	Ek Parça Connector	100	1,590 kg	0,01000
001 044 100050 00 00	Uç Tapa Blind Cap	40	0,736 kg	0,00400
001 043 100050 01 00	Ek parça (3'lü Set) Connector (3 set)	100	1,380 kg	0,01000
001 046 195100 00 00	Kanal İçi Küp Buat Duct Junction Cube	25	1,408 kg	0,00828



Koruma Bantlı
Protecting Foil

100x50



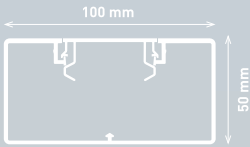



Kaidesiz
Compatible With Mounting
Without Base



MEKPLUS Serisi Series

Ürün Kodu	Product Code	001 006 100050 20 00
Ambalaj Şekli	Packing Type	Kutu - Box
Adet / m	Quantity / m	20 m
Ağırlık	Weight	20,168 kg
m ³ /	Volume	0,12000

AKSESUARLAR - ACCESSORIES

Kod Code	Ürün Product	Adet Quantity	Ağırlık Weight	m ³ Volume
 001 013 100048 20 00	Ara Bölme Partition	150 m	19,605 kg	0,07500
 001 039 100051 00 00	İç Köşe Internal Corner	8	0,600 kg	0,01011
 001 040 100051 00 00	Dış Köşe External Corner	8	0,880 kg	0,00653
 001 041 100051 00 00	T Köşe T Corner	10	1,150 kg	0,01364
 001 042 100051 00 00	90° L Köşe 90° L Corner	10	1,080 kg	0,01364
 001 043 100051 00 00	Ek Parça Connector	100	1,585 kg	0,01000
 001 044 100051 00 00	Uç Tapa Blind Cap	40	0,735 kg	0,00400
 001 888 100050 00 00	Kilitleme Aparatı Locking Apparatus	50	0,385 kg	0,00282



120x70

Aksesuarsız
Without Accessories



MEKPLUS Serisi Series

Ürün Kodu	Product Code	001 003 120070 20 00
Ambalaj Şekli	Packing Type	Kutu - Box
Adet / m	Quantity / m	16 m
Ağırlık	Weight	25,673 kg
m ³ /	Volume	0,18189

AKSESUARLAR - ACCESSORIES

Kod Code	Ürün Product	Adet Quantity	Ağırlık Weight	m ³ Volume
 001 013 120070 20 00	Ara Bölme Partition	60 m	10,160	0,07956

100x50

Kaidesiz
Compatible With Mounting
Without Base





Koruma Bantlı
Protecting Foil



170x50



MEKSPLUS Serisi Series

Ürün Kodu	Product Code	001 003 170050 20 00
Ambalaj Şekli	Packing Type	Kutu - Box
Adet / m	Quantity / m	12 m
Ağırlık	Weight	25,560 kg
m ³ /	Volume	0,12120

AKSESUARLAR - ACCESSORIES

Kod Code	Ürün Product	Adet Quantity	Ağırlık Weight	m ³ Volume
001 039 170050 00 00	İç Köşe Internal Corner	32	2,848 kg	0,07500
001 040 170050 00 00	Dış Köşe External Corner	8	0,704 kg	0,01011
001 041 170050 00 00	T Köşe T Corner	16	3,749 kg	0,00653
001 042 170050 00 00	90° L Köşe 90° L Corner	16	2,997 kg	0,01364
001 043 170050 00 00	Ek Parça Connector	125	19,000 kg	0,01364
001 044 170050 00 00	Uç Tapa Blind Cap	125	4,250 kg	0,01000



170x70

Aksesuarsız
Without Accessories

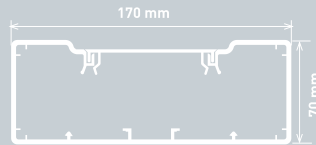

MEKSPLUS Serisi Series

Ürün Kodu	Product Code	001 003 170070 20 00
Ambalaj Şekli	Packing Type	Kutu - Box
Adet / m	Quantity / m	12 m
Ağırlık	Weight	29,365 kg
m ³ /	Volume	0,17357

AKSESUARLAR - ACCESSORIES

Kod Code	Ürün Product	Adet Quantity	Ağırlık Weight	m ³ Volume
001 013 120070 20 00	Ara Bölme Partition	60 m	10,160	0,07956

**250x70****Aksesuarsız**
Without Accessories**MEKSPLUS** Serisi Series

Ürün Kodu	Product Code	001 003 250070 20 00
Ambalaj Şekli	Packing Type	Kutu - Box
Adet / m	Quantity / m	8 m
Ağırlık	Weight	22,952 kg
m ³ /	Volume	0,17360

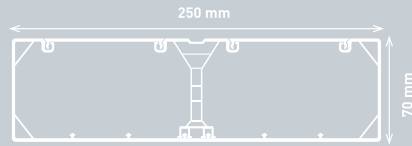
Priz Montaj Setsiz
Without Plug Socket Assembly Set**250x70****Bölmeli - Partitioned**
Aksesuarsız - Without Accessories**MEKSPLUS** Serisi Series

Ürün Kodu	Product Code	001 003 250970 20 00
Ambalaj Şekli	Packing Type	Kutu - Box
Adet / m	Quantity / m	8 m
Ağırlık	Weight	25,848 kg
m ³ /	Volume	0,17360

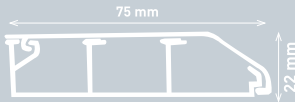
75x22

MEKS Serisi Series

Ürün Kodu	Product Code	001 002 975022 20 00
Ambalaj Şekli	Packing Type	Kutu - Box
Adet / m	Quantity / m	50 m
Ağırlık	Weight	33,743 kg
m ³ /	Volume	0,09685

AKSESUARLAR - ACCESSORIES

Kod Code	Ürün Product	Adet Quantity	Ağırlık Weight	m ³ Volume
001 039 075022 00 00	İç Köşe Internal Corner	20	0,446 kg	0,01010
001 040 075022 00 00	Dış Köşe External Corner	20	0,471 kg	0,01010
001 043 075022 00 00	Ek Parça Connector	100	0,500 kg	0,00290
001 044 075022 01 00	Sağ Uç Tapa Blind Cap Right	30	0,195 kg	0,00138
001 044 075022 02 00	Sol Uç Tapa Blind Cap Left	20	0,130 kg	0,00092

74x20

Tam Kapaklı Bölmeli
Full Cover And Partitioned

EKO Serisi Series

MEKS Serisi Series

Ürün Kodu	Product Code	001 014 974020 20 00	001 002 974020 20 00
Ambalaj Şekli	Packing Type	Kutu - Box	Kutu - Box
Adet / m	Quantity / m	50 m	50 m
Ağırlık	Weight	29,295 kg	29,295 kg
m ³ /	Volume	0,09500	0,09500

AKSESUARLAR - ACCESSORIES

Kod Code	Ürün Product	Adet Quantity	Ağırlık Weight	m ³ Volume
001 039 074020 00 00	İç Köşe Internal Corner	20	0,402 kg	0,00293
001 040 074020 00 00	Dış Köşe External Corner	20	0,424 kg	0,00293
001 041 074020 00 00	T Köşe T Corner	30	1,350 kg	0,01011
001 042 074020 00 00	90° L Köşe 90° L Corner	40	1,444 kg	0,01011
001 043 074020 00 00	Ek Parça Connector	50	0,430 kg	0,00293
001 044 074020 00 00	Uç Tapa Blind Cap	50	0,550 kg	0,00293
001 047 0117420 00 00	P, M Kasası Socket Assembly Frame	6	0,574 kg	0,00300
001 047 017421 00 00	P, M Kasası 1'li Socket Assembly Frame Single	12	1,290 kg	0,00600
001 047 017422 00 00	P, M Kasası 2'li Socket Assembly Frame Double	12	2,400 kg	0,01320
001 047 017423 00 00	P, M Kasası 3'lü Socket Assembly Frame Triple	12	3,600 kg	0,01920

İÇTEN KAPAKLI PRİZ MONTAJ SETLERİ

Socket Assembly Adaptor for Internal Cover Trunkings

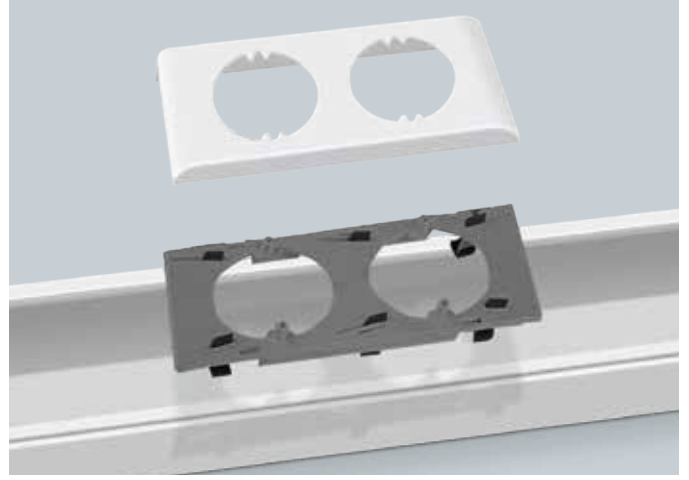
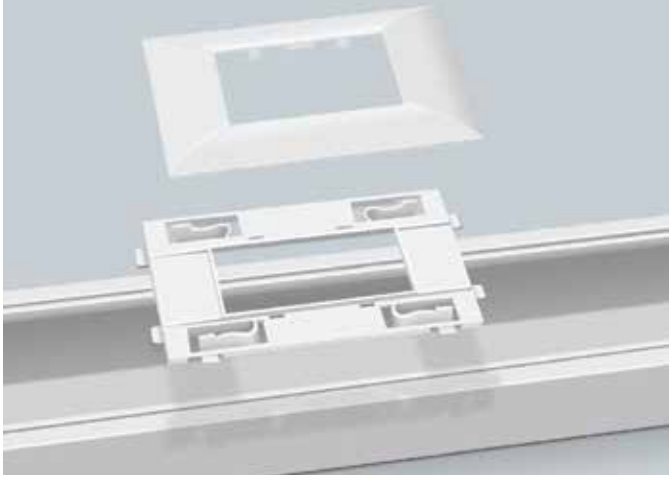

45x45 Tekli Çerçeve Single Frame



Ürün Kodu	Product Code	001 047 070001 00 00
Ambalaj Şekli	Packing Type	Kutu - Box
Adet / m	Quantity / m	20 m
Ağırlık	Weight	1,118 kg
m ³ /	Volume	0,00600

55x55 Tekli Çerçeve Single Frame



Ürün Kodu	Product Code	001 047 080001 00 00
Ambalaj Şekli	Packing Type	Kutu - Box
Adet / m	Quantity / m	20 m
Ağırlık	Weight	1,275 kg
m ³ /	Volume	0,00652

45x45 İkili Çerçeve Double Frame



Ürün Kodu	Product Code	001 047 070002 00 00
Ambalaj Şekli	Packing Type	Kutu - Box
Adet / m	Quantity / m	14 m
Ağırlık	Weight	1,072 kg
m ³ /	Volume	0,00560

55x55 İkili Çerçeve Double Frame



Ürün Kodu	Product Code	001 047 080002 00 00
Ambalaj Şekli	Packing Type	Kutu - Box
Adet / m	Quantity / m	14 m
Ağırlık	Weight	1,308 kg
m ³ /	Volume	0,00666

45x45 Üçlü Çerçeve Triple Frame



Ürün Kodu	Product Code	001 047 070003 00 00
Ambalaj Şekli	Packing Type	Kutu - Box
Adet / m	Quantity / m	12 m
Ağırlık	Weight	1,079 kg
m ³ /	Volume	0,00600

55x55 Üçlü Çerçeve Triple Frame



Ürün Kodu	Product Code	001 047 080003 00 00
Ambalaj Şekli	Packing Type	Kutu - Box
Adet / m	Quantity / m	10 m
Ağırlık	Weight	1,212 kg
m ³ /	Volume	0,00667

45x45 Dörtlü Çerçeve Quartet Frame



Ürün Kodu	Product Code	001 047 070004 00 00
Ambalaj Şekli	Packing Type	Kutu - Box
Adet / m	Quantity / m	10 m
Ağırlık	Weight	1,181 kg
m ³ /	Volume	0,00617



**45x22.5 Data
Priz Kapağı**
45x22.5 Data
Socket Frame
888 049 050012



**Data Konnektörü
1x8 CAT 6**
Data Connector
1x8 CAT 6
888 049 050032



**Kanal Kilitleme
Aparatı**
It prevents
stretching which
could occur in time

001 050 030004 00 00
Kanalda zamanla oluşabilecek esnemelerin önüne geçer.
Prevents back last that could occur in the trunking.

001 052 300001 00 00
45x45 Topraklı
Priz Çekirdekleri 45°
45x45 Earthed Socket Cores 45°



001 052 300002 00 00
45x45 UPS
Priz Çekirdekleri 45°
45x45 UPS Socket Cores 45°



001 052 200005 00 00
45x45 UPS ve Topraklı
Priz Birleştirme Aparatı
45 x 45 UPS and earthed socket
connection apparatus



888 049 050013
45x45 Data Priz Kapağı
45x45 Data Socket Cover



001 050 030003 00 00
100x37/50
Kanal Kilitleme Aparatı
Trunking Locking Apparatus



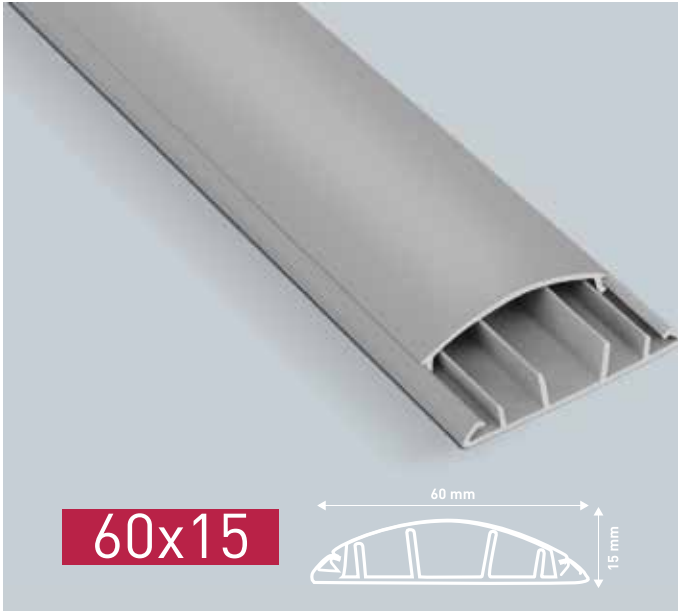

Ürün Kodu	Product Code	001 002 060015 20 17
Ambalaj Şekli	Packing Type	Kutu - Box
Adet / m	Quantity / m	40 m
Ağırlık	Weight	14,572 kg
m ³ /	Volume	0,03564

AKSESUARLAR - ACCESSORIES

Kod Code	Ürün Product	Adet Quantity	Ağırlık Weight	m ³ Volume
001 041 060015 00 17	T Köşe T Corner	10	0,490 kg	0,00300
001 042 060015 00 17	L Köşe L Corner	24	0,495 kg	0,00240
001 043 060015 00 17	Ek Parça Connector	50	0,245 kg	0,00139
001 044 060015 00 17	Uç Tapa Blind Cap	50	0,240 kg	0,00139



Ürün Kodu	Product Code	001 002 075018 20 17
Ambalaj Şekli	Packing Type	Kutu - Box
Adet / m	Quantity / m	30 m
Ağırlık	Weight	19,239 kg
m ³ /	Volume	0,04140

AKSESUARLAR - ACCESSORIES

Kod Code	Ürün Product	Adet Quantity	Ağırlık Weight	m ³ Volume
001 041 075018 00 17	T Köşe T Corner	8	0,440 kg	0,00293
001 042 075018 00 17	L Köşe L Corner	15	0,400 kg	0,00293
001 043 075018 00 17	Ek Parça Connector	50	0,200 kg	0,00139
001 044 075018 00 17	Uç Tapa Blind Cap	50	0,270 kg	0,00139



Ürün Kodu	Product Code	001 002 090020 20 17
Ambalaj Şekli	Packing Type	Kutu - Box
Adet / m	Quantity / m	20 m
Ağırlık	Weight	16,580 kg
m ³ /	Volume	0,04000

AKSESUARLAR - ACCESSORIES

Kod Code	Ürün Product	Adet Quantity	Ağırlık Weight	m ³ Volume
001 041 090020 00 17	T Köşe T Corner	12	1,030 kg	0,00960
001 042 090020 00 17	L Köşe L Corner	20	0,765 kg	0,00600
001 043 090020 00 17	Ek Parça Connector	50	0,220 kg	0,00505
001 044 090020 00 17	Uç Tapa Blind Cap	50	0,310 kg	0,00244



H Profil 8

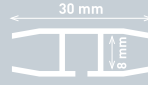

Ürün Kodu	Product Code	001 015 008000 20 00
Ambalaj Şekli	Packing Type	Kutu - Box
Adet / m	Quantity / m	100 m
Ağırlık	Weight	16,500 kg
m ³ /	Volume	0,03121

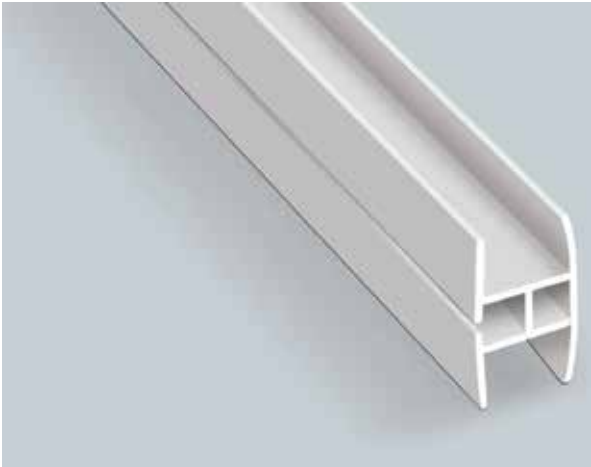

H Profil 10

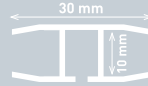

Ürün Kodu	Product Code	001 015 010000 20 00
Ambalaj Şekli	Packing Type	Kutu - Box
Adet / m	Quantity / m	100 m
Ağırlık	Weight	18,000 kg
m ³ /	Volume	0,03745

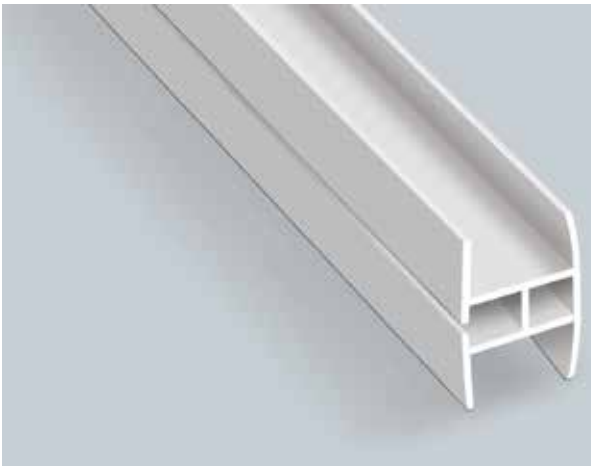

H Profil 12

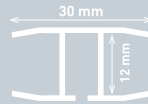

Ürün Kodu	Product Code	001 015 012000 20 00
Ambalaj Şekli	Packing Type	Kutu - Box
Adet / m	Quantity / m	100 m
Ağırlık	Weight	19,500 kg
m ³ /	Volume	0,04369



9.5x7

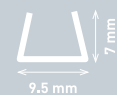

Şeffaf Mini Kanal
(Kapaksız - Yapışkanlı)
Transparent Mini Trunking
(Without Cover - With Adhesive)

Ürün Kodu	Product Code	001 015 010007 20 00
Ambalaj Şekli	Packing Type	Kutu - Box
Adet / m	Quantity / m	500 m
Ağırlık	Weight	16,450 kg
m ³ /	Volume	0,05050

Klima Kanalı

Air Conditioning
Trunking

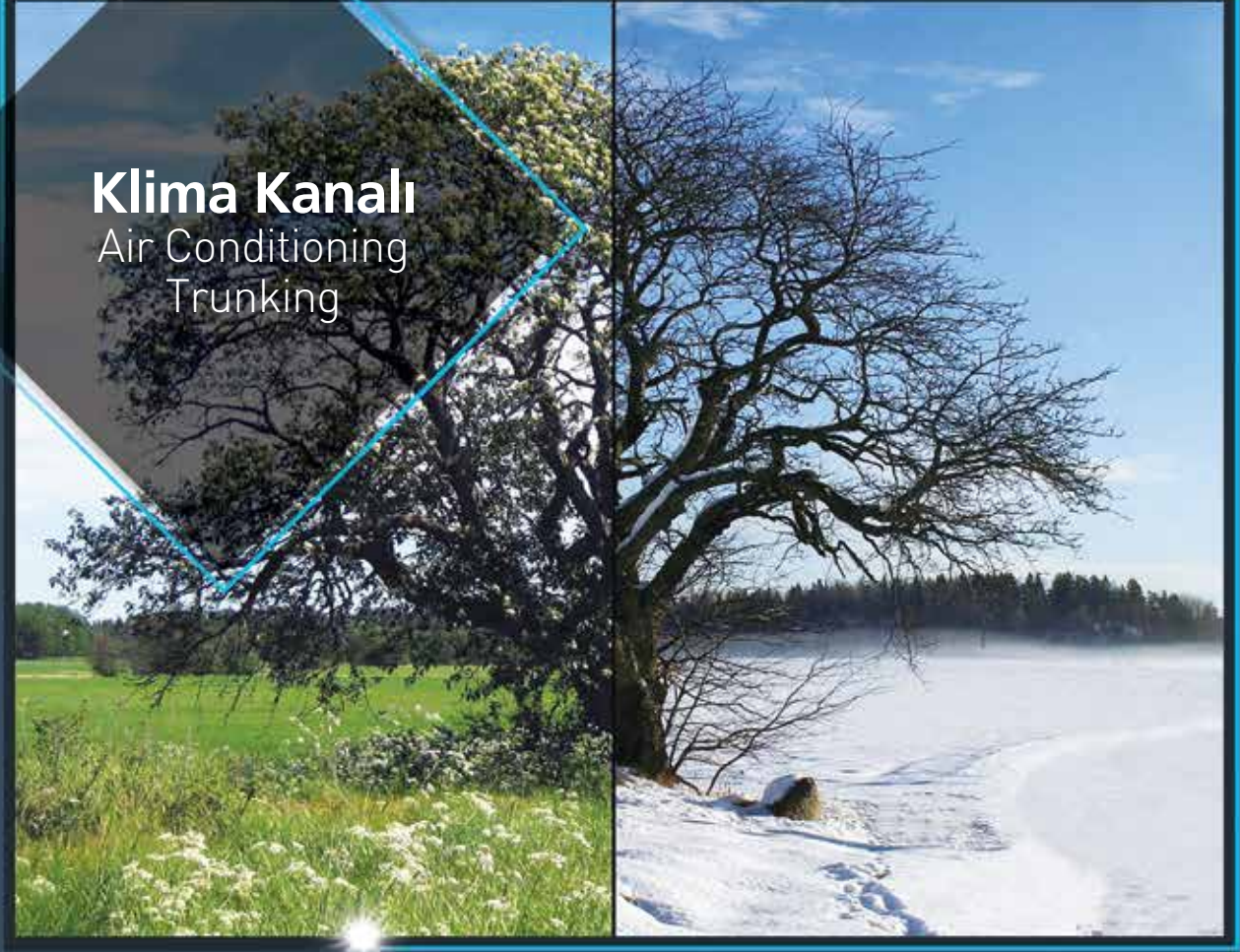

Dış Uç Tapa
External Blind Cap

Ek Parça
Connector

İç Köşe
Internal Corner

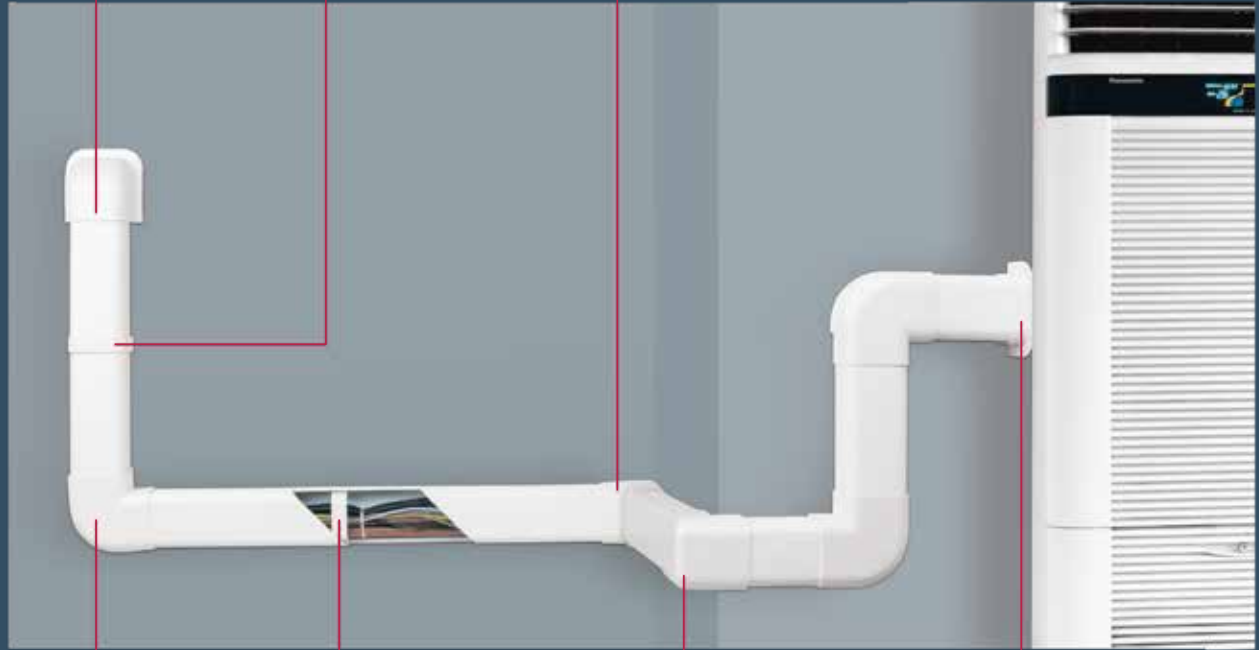

90° L Köşe
90° L Corner

Kablo Tutucu
Cable Holder

Dış Köşe
External Corner

Duvar Geçisi
Wall Penetration



75x60

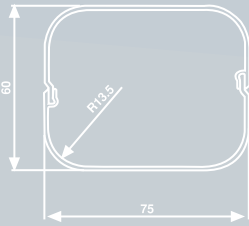

MEKS Serisi
Series

Ürün Kodu	Product Code	001 002 075060 20 17
Ambalaj Şekli	Packing Type	Kutu - Box
Adet / m	Quantity / m	30 m
Ağırlık	Weight	18,643 kg
m ³ /	Volume	0,09663

AKSESUARLAR - ACCESSORIES

Kod Code	Ürün Product	Adet Quantity	Ağırlık Weight	m ³ Volume
 001 039 075060 00 00	İç Köşe Internal Corner	24	0,895 kg	0,01011
 001 040 075060 00 00	Dış Köşe External Corner	24	1,265 kg	0,01011
 001 042 075060 00 00	90° L Köşe 90° L Corner	18	1,115 kg	0,01011
 001 043 075060 00 00	Ek Parça Connector	40	0,380 kg	0,00293
 001 044 075060 00 00	İç Uç Tapa Internal Blind Cap	30	0,980 kg	0,01011
 001 044 075060 02 00	Dış Uç Tapa External Blind Cap	18	0,820 kg	0,01011
 001 050 030001 00 00	Duvar Geçişli Wall Penetration	60	0,905 kg	0,01011
 001 050 030002 00 00	Kablo Tutucu Cable Holder	60	0,460 kg	0,00293

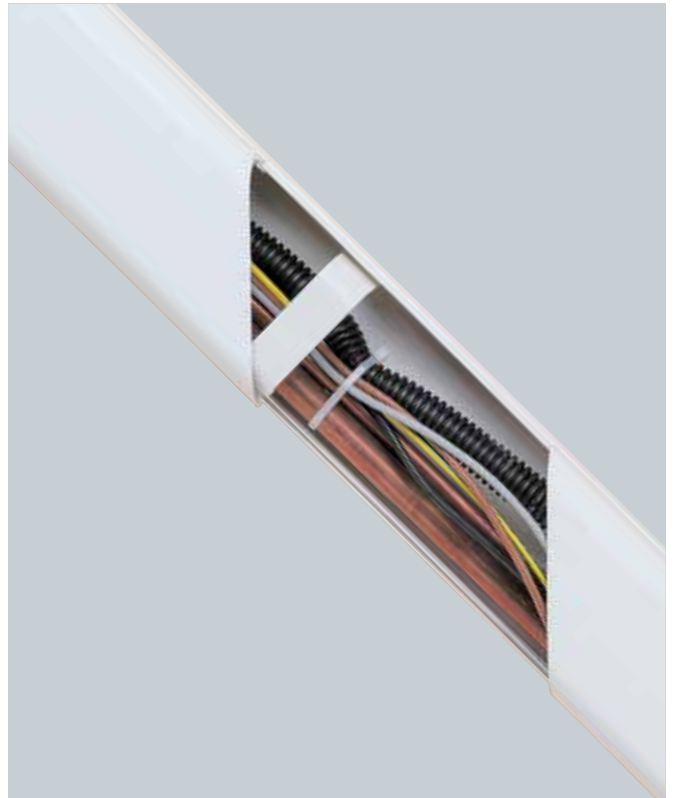

Sidem serisi kablo kanalları

Sidem series
cable trunking



Sidem

Tüm ebatlardaki kablo kanallarımız ve aksesuarları bu bölümdeki renk seçenekleri ile boyanabilir özelliktedir.

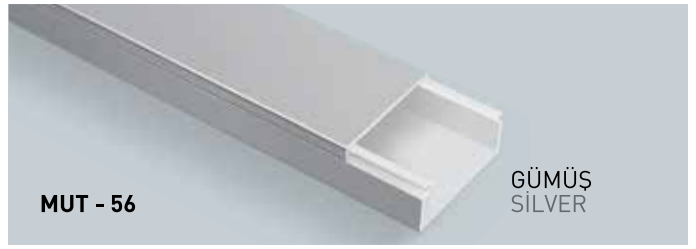
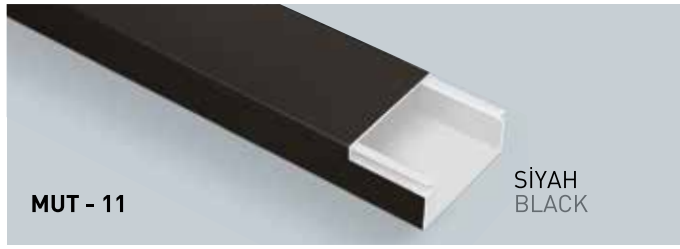
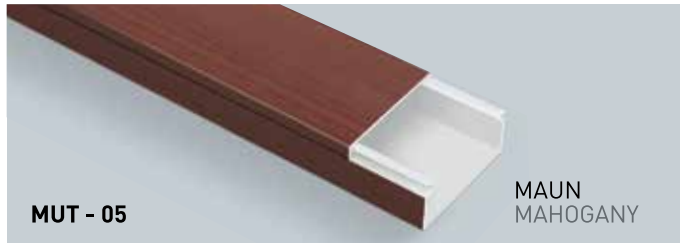
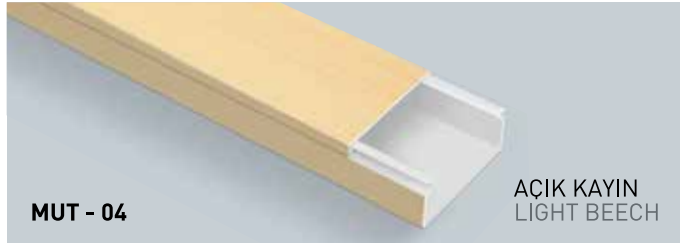
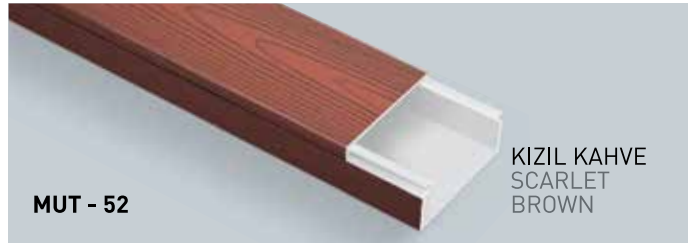
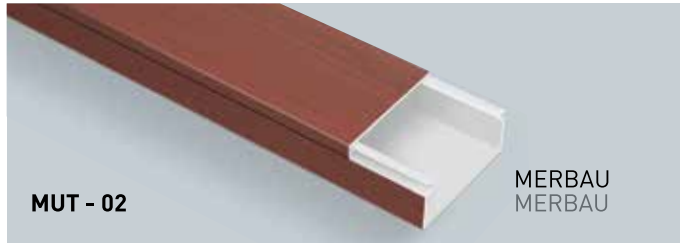

The cable trunking and accessories of all sizes can be painted with the available color options presented in this chapter.

RENK SEÇENEKLERİ COLOR OPTIONS**AHŞAP RENK SEÇENEKLERİ** WOOD COLOR OPTIONS**AKSESUARLAR** ACCESSORIES

**Delikli kablo
kanallarımızın
Teknik Özellikleri**
Technical specifications
for perforated cable
trunkings



Ultraviyole ışınlarına
karşı dayanıklıdır.
Resistance to UV light.



Asit buharına
dayanıklılıdır.
Resistance to acidic
vapor.

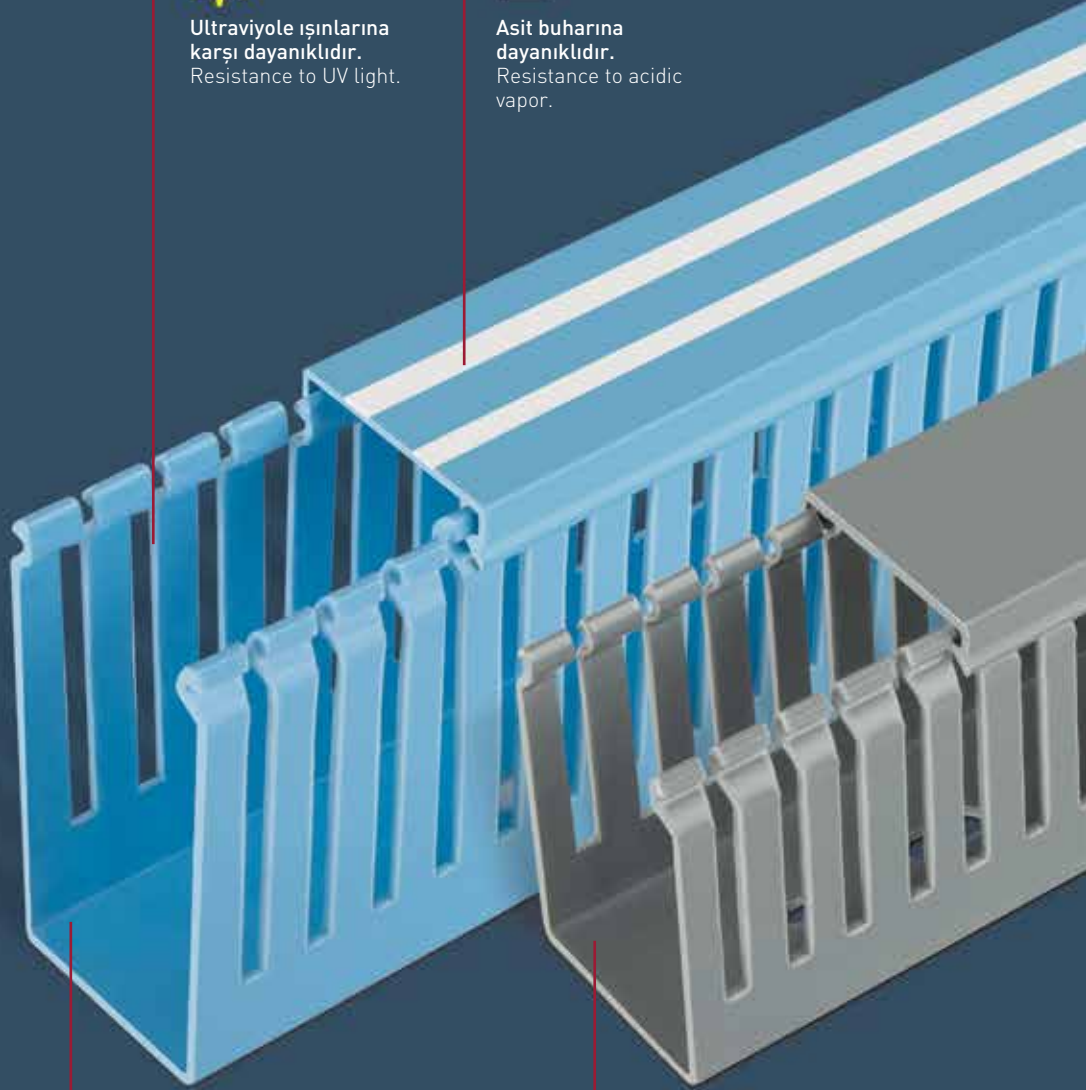

Tüm kanallarımız çift
tarafli yapışkanlı bant
ile kullanılabilir.
Adhesive models are
easy to install.



Aşırı soğuşa ve sıcağa
karşı dayanıklı.
Resistant to extreme
cold and heat.

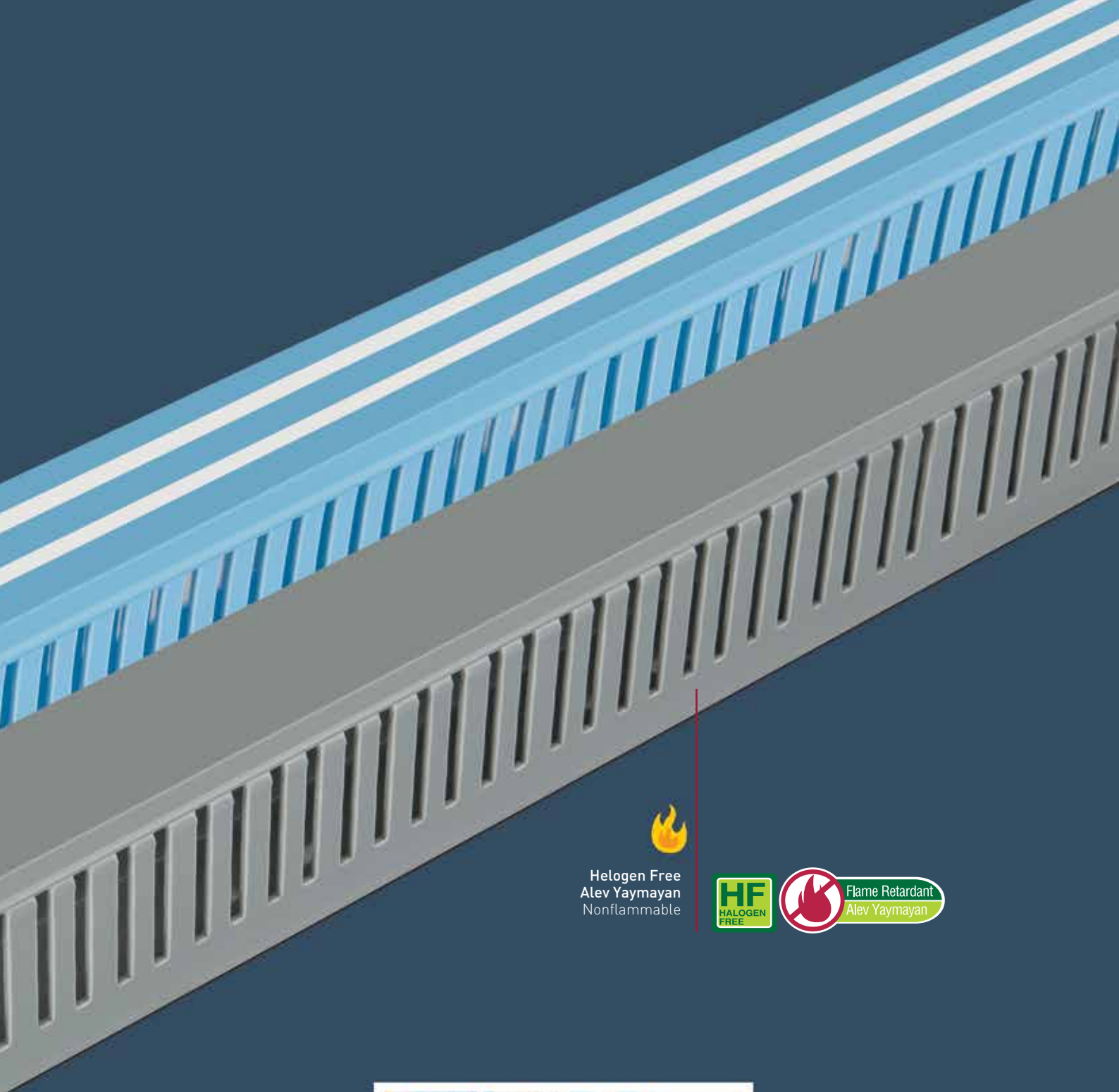

Helogen Free
Alev Yaymayan
Nonflammable



Kolay yapışmayı sağlayan,
Çift taraflı bant kullanılabilir.

Double sided adhesive
Tape assuring easy fixation
Can be used

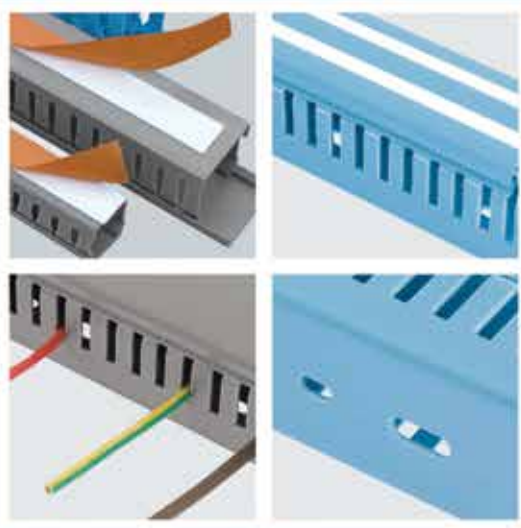

Kablo çıkışları için
belirli aralıklar
Regular intervals for
cable outlets

Yazı yazmayı kolaylaştıran
beyaz bant

Easy-to-write
white strips

Düzenli aralıklarla
montaj delikleri

Assembly holes with
regular intervals

HALOGEN FREE DELİKLİ KABLO KANALI

HALOGEN FREE PERFORATED CABLE TRUNKING



Flame Retardant
Alev Yaymayan

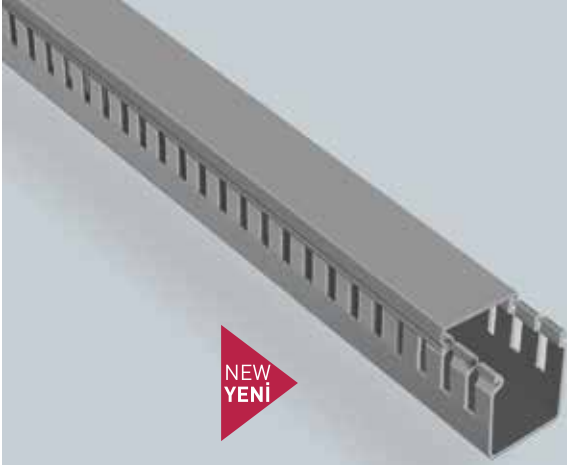

NEW
YENİ



Flame Retardant
Alev Yaymayan

25x25

Gri
Grey

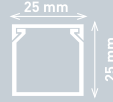

Ürün Kodu	Product Code	001 065 025025 20 17
Ambalaj Şekli	Packing Type	Kutu - Box
Adet / m	Quantity / m	120 m
Ağırlık	Weight	20,465 kg
m ³ /	Volume	0,09360

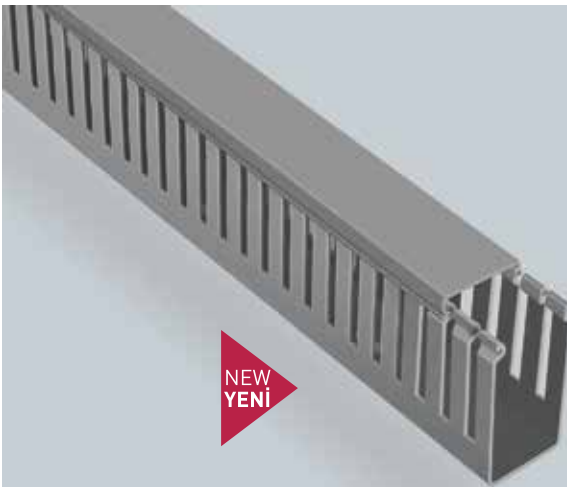

NEW
YENİ



Flame Retardant
Alev Yaymayan

25x40

Gri
Grey

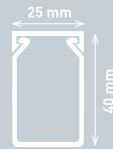

Ürün Kodu	Product Code	001 065 025040 20 17
Ambalaj Şekli	Packing Type	Kutu - Box
Adet / m	Quantity / m	80 m
Ağırlık	Weight	18,864 kg
m ³ /	Volume	0,09600

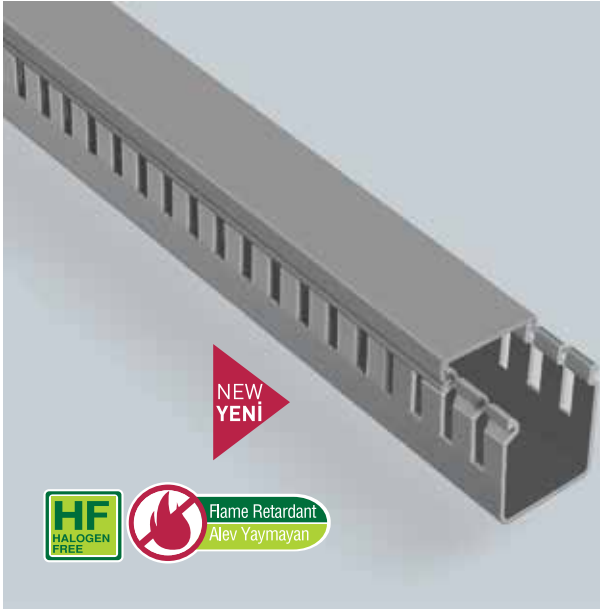
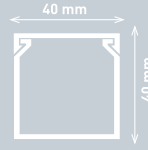
**40x40****Gri**
Grey

Ürün Kodu	Product Code	001 065 040040 20 17
Ambalaj Şekli	Packing Type	Kutu - Box
Adet / m	Quantity / m	50 m
Ağırlık	Weight	15,375 kg
m ³ /	Volume	0,10000

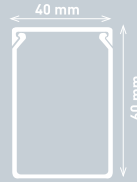
**40x60****Gri**
Grey

Ürün Kodu	Product Code	001 065 040060 20 17
Ambalaj Şekli	Packing Type	Kutu - Box
Adet / m	Quantity / m	48 m
Ağırlık	Weight	19,680 kg
m ³ /	Volume	0,14400

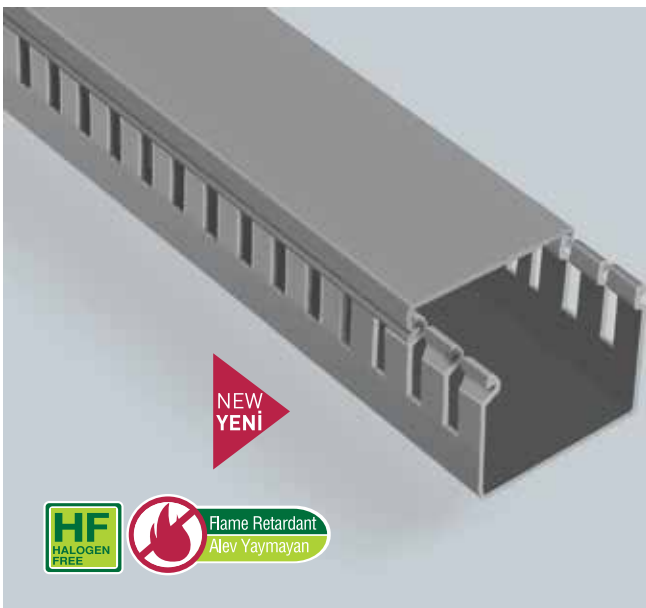
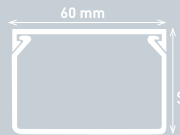
**60x40****Gri**
Grey

Ürün Kodu	Product Code	001 065 060040 20 17
Ambalaj Şekli	Packing Type	Kutu - Box
Adet / m	Quantity / m	48 m
Ağırlık	Weight	21,672 kg
m ³ /	Volume	0,14400

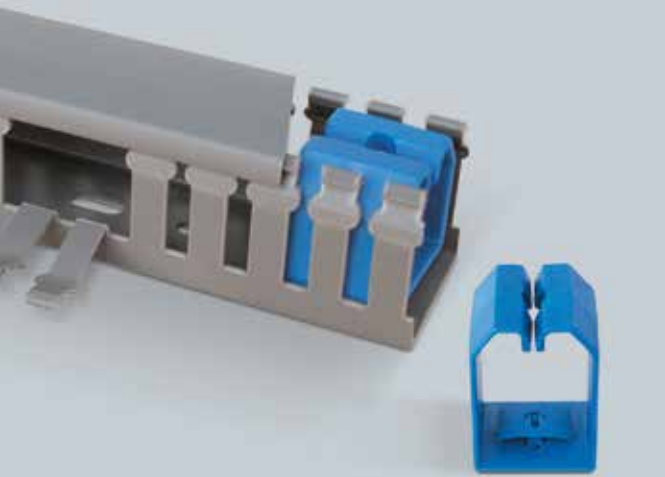
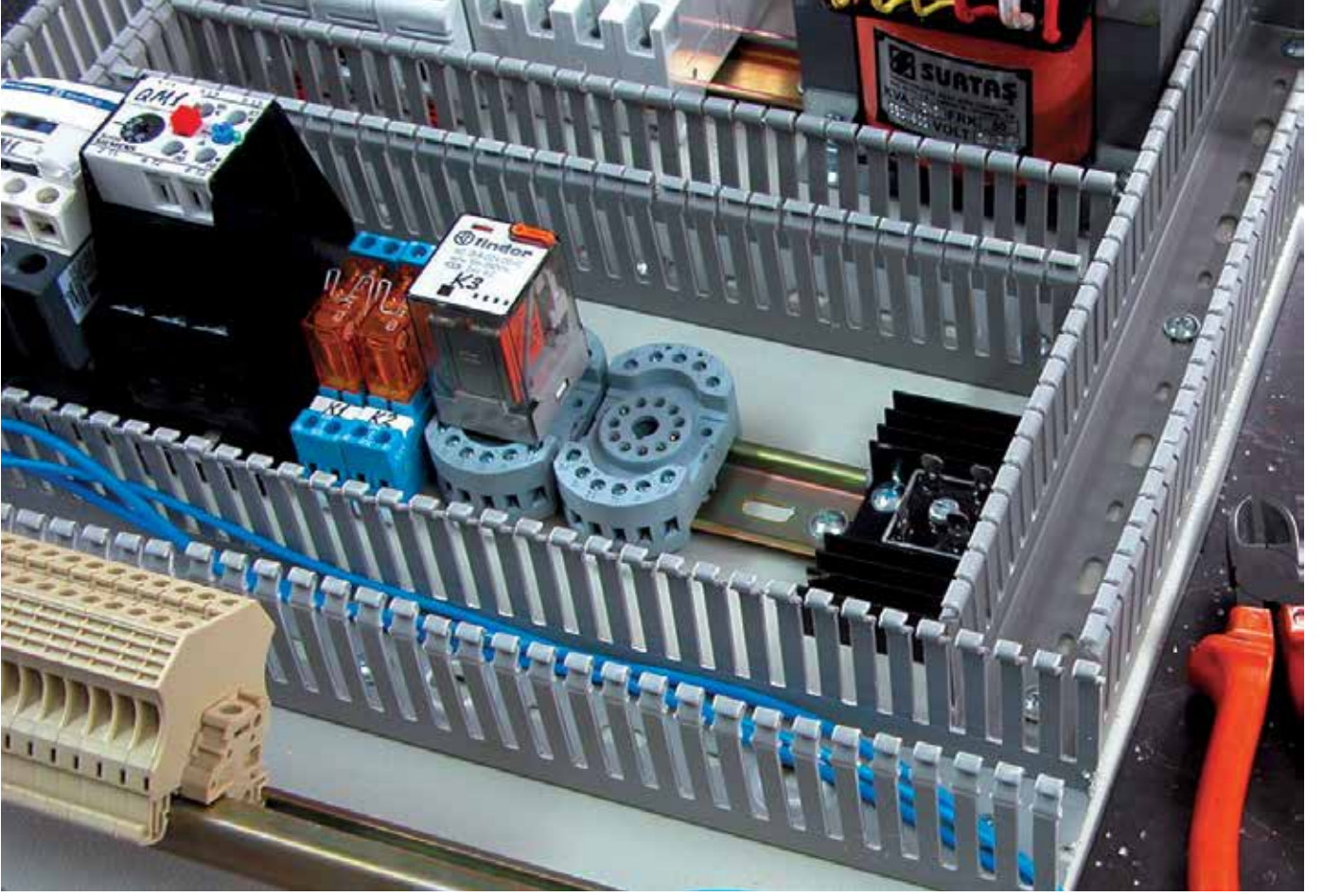

Kablo Tutucu Aparatı
Cable Holder Apparatus

		25x40	40x40	60x40
Ürün Kodu	Product Code	001 050 010001 00 00	001 050 010002 00 00	001 050 010003 00 00
Ambalaj Şekli	Packing Type	Kutu - Box	Kutu - Box	Kutu - Box
Adet / m	Quantity / m	-	40	50
Ağırlık	Weight	-	0,395 kg	0,445 kg
m ³ /	Volume	-	-	0,00400



Kablo Tutucu Yan Aparatı
Cable Holder Side Apparatus

		40x40/60	60x40/60	80x60	100x60
Ürün Kodu	Product Code	001 050 020001 00 00	001 050 020002 00 00	001 050 020003 00 00	001 050 020004 00 00
Ambalaj Şekli	Packing Type	Kutu - Box	Kutu - Box	Kutu - Box	Kutu - Box
Adet / m	Quantity / m	100	100	100	100
Ağırlık	Weight	0,270 kg	0,210 kg	0,260 kg	0,340 kg
m ³ /	Volume	0,00139	0,00160	0,00300	0,00300

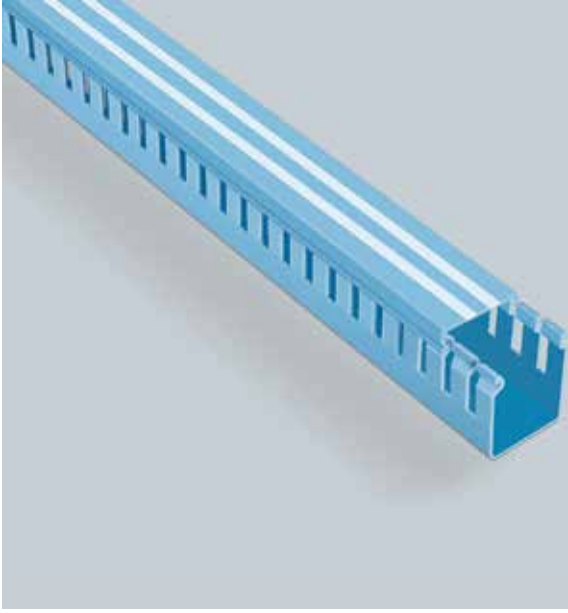
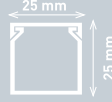
**25x25****Mavi**
Blue

Ürün Kodu	Product Code	001 005 025025 20 13
Ambalaj Şekli	Packing Type	Kutu - Box
Adet / m	Quantity / m	120 m
Ağırlık	Weight	20,465 kg
m ³ /	Volume	0,09360

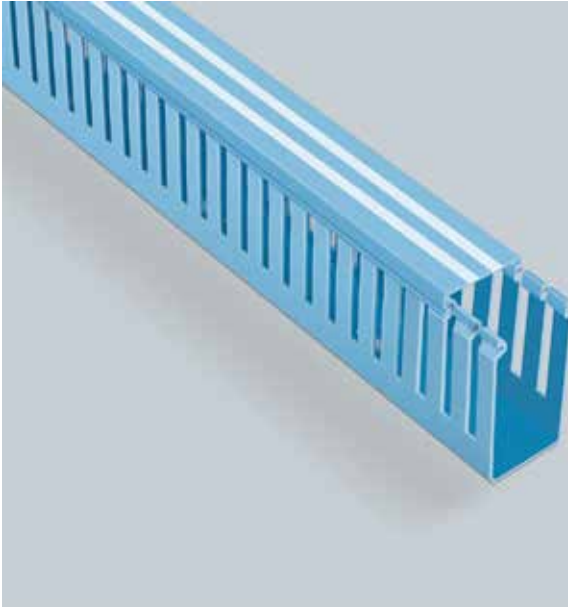
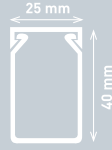
**25x40****Mavi**
Blue

Ürün Kodu	Product Code	001 005 025040 20 13
Ambalaj Şekli	Packing Type	Kutu - Box
Adet / m	Quantity / m	80 m
Ağırlık	Weight	18,865 kg
m ³ /	Volume	0,09920

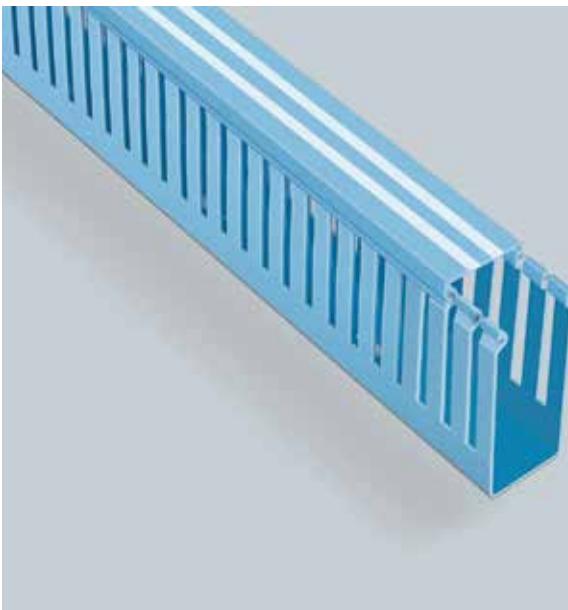
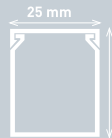
**25x60****Mavi**
Blue

Ürün Kodu	Product Code	001 005 025060 20 13
Ambalaj Şekli	Packing Type	Kutu - Box
Adet / m	Quantity / m	80 m
Ağırlık	Weight	32,960 kg
m ³ /	Volume	0,14400

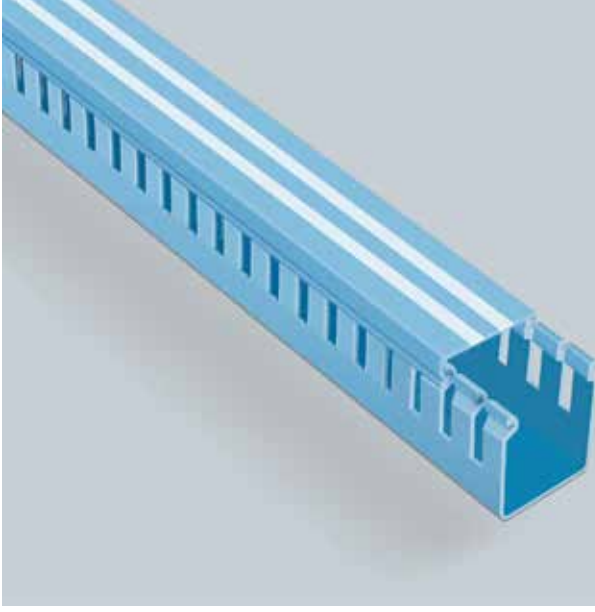
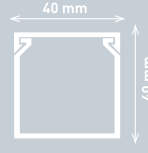
**40x40****Mavi**
Blue

Ürün Kodu	Product Code	001 005 040040 20 13
Ambalaj Şekli	Packing Type	Kutu - Box
Adet / m	Quantity / m	50 m
Ağırlık	Weight	15,375 kg
m ³ /	Volume	0,10000

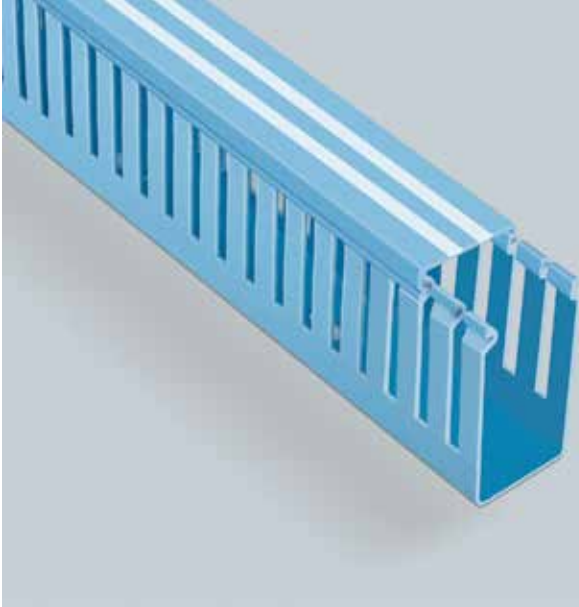
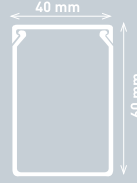
**40x60****Mavi**
Blue

Ürün Kodu	Product Code	001 005 040060 20 13
Ambalaj Şekli	Packing Type	Kutu - Box
Adet / m	Quantity / m	48 m
Ağırlık	Weight	19,680 kg
m ³ /	Volume	0,14400

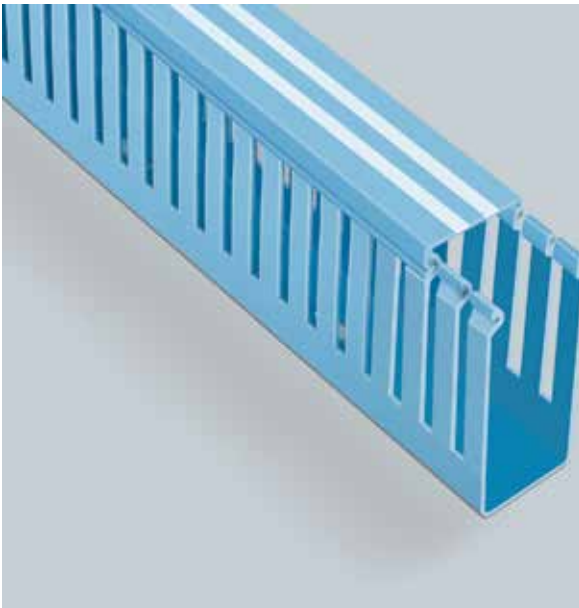
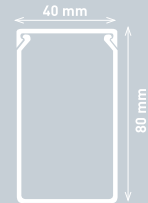
**40x80****Mavi**
Blue

Ürün Kodu	Product Code	001 005 040080 20 13
Ambalaj Şekli	Packing Type	Kutu - Box
Adet / m	Quantity / m	36 m
Ağırlık	Weight	21,706 kg
m ³ /	Volume	0,14393

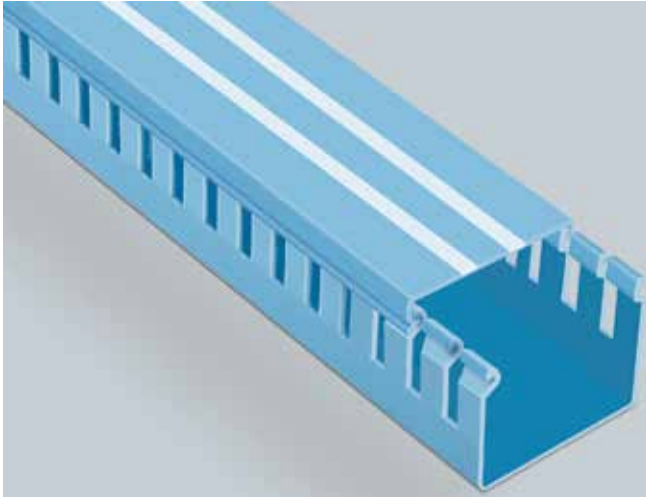
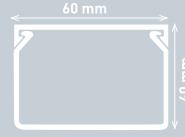
**60x40****Mavi**
Blue

Ürün Kodu	Product Code	001 005 060040 20 13
Ambalaj Şekli	Packing Type	Kutu - Box
Adet / m	Quantity / m	48 m
Ağırlık	Weight	21,670 kg
m ³ /	Volume	0,14390

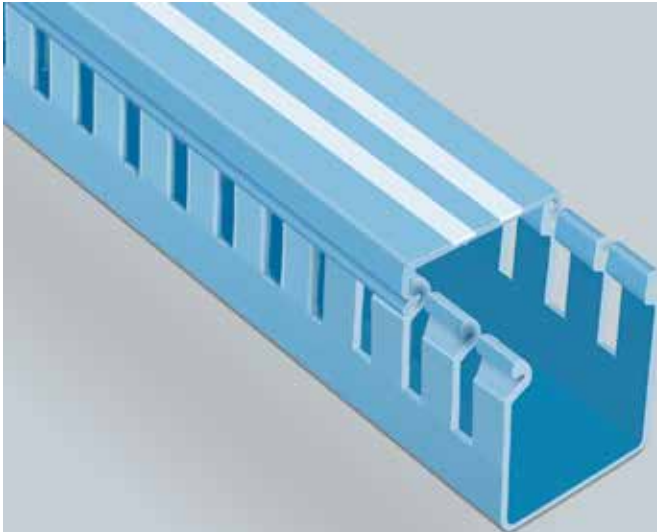
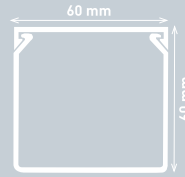
**60x60****Mavi**
Blue

Ürün Kodu	Product Code	001 005 060060 20 13
Ambalaj Şekli	Packing Type	Kutu - Box
Adet / m	Quantity / m	32 m
Ağırlık	Weight	17,440 kg
m ³ /	Volume	0,14400

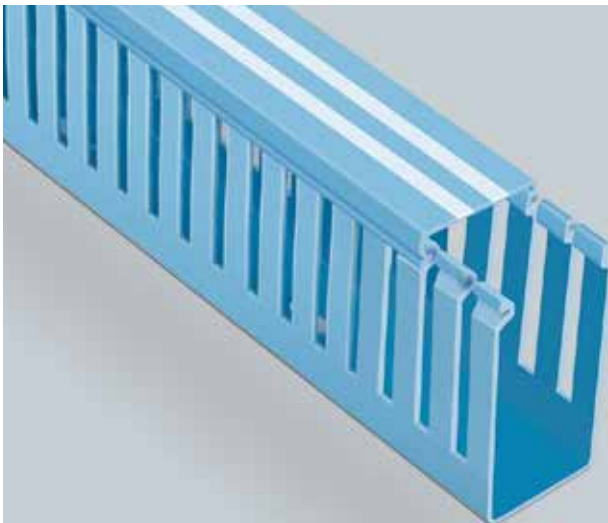
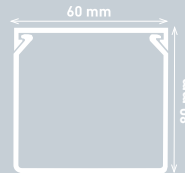
**60x80****Mavi**
Blue

Ürün Kodu	Product Code	001 005 060080 20 13
Ambalaj Şekli	Packing Type	Kutu - Box
Adet / m	Quantity / m	24 m
Ağırlık	Weight	15,120 kg
m ³ /	Volume	0,11520

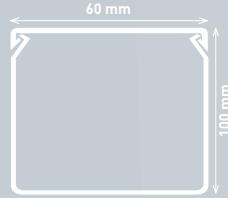
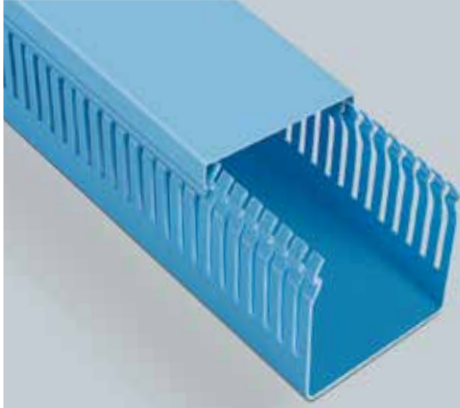
**60x100****Mavi**
Blue

Ürün Kodu	Product Code	001 005 060100 20 13
Ambalaj Şekli	Packing Type	Kutu - Box
Adet / m	Quantity / m	16 m
Ağırlık	Weight	11,680 kg
m ³ /	Volume	0,09600

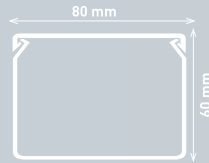
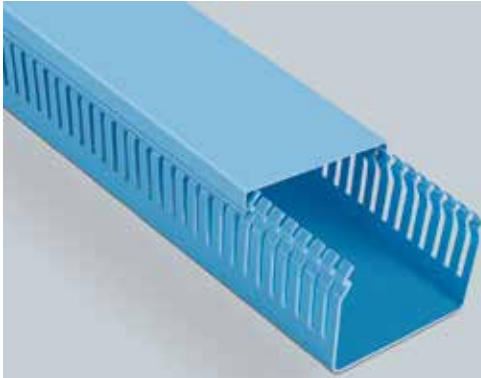
**80x60****Mavi**
Blue

Ürün Kodu	Product Code	001 005 080060 20 13
Ambalaj Şekli	Packing Type	Kutu - Box
Adet / m	Quantity / m	24 m
Ağırlık	Weight	16,030 kg
m ³ /	Volume	0,14390

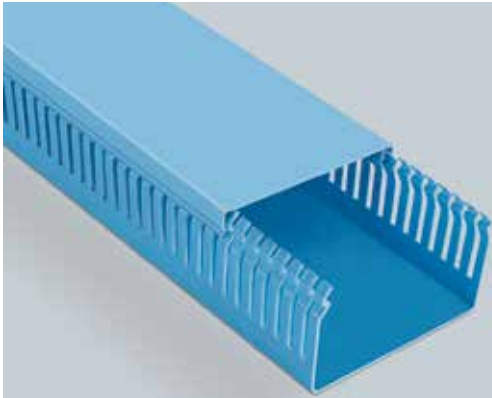
**100x60****Mavi**
Blue

Ürün Kodu	Product Code	001 005 100060 20 13
Ambalaj Şekli	Packing Type	Kutu - Box
Adet / m	Quantity / m	16 m
Ağırlık	Weight	13,590 kg
m ³ /	Volume	0,14390

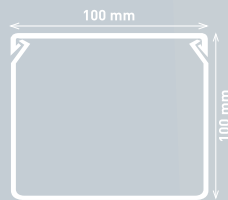
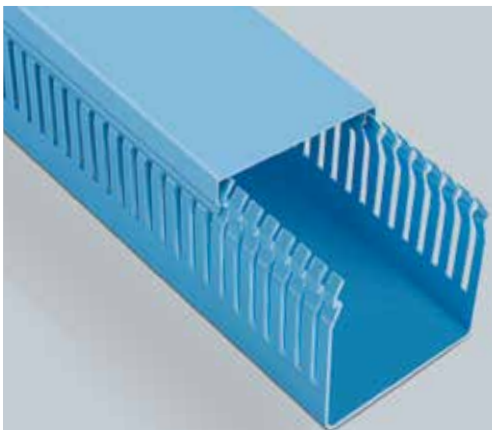
**100x100****Mavi**
Blue

Ürün Kodu	Product Code	001 005 100100 20 13
Ambalaj Şekli	Packing Type	Kutu - Box
Adet / m	Quantity / m	8 m
Ağırlık	Weight	10,622 kg
m ³ /	Volume	0,07680

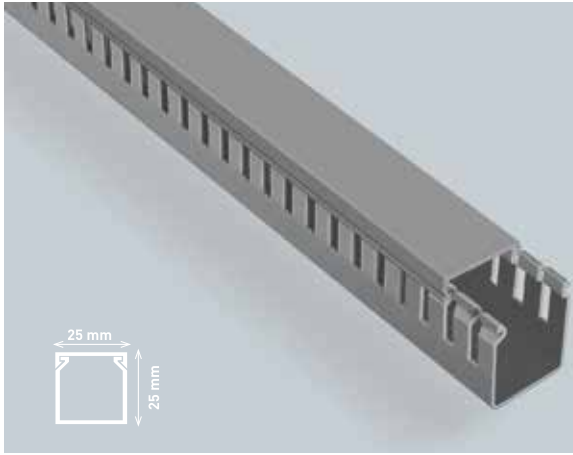
**25x25****Gri**
Grey

Ürün Kodu	Product Code	001 005 025025 20 17
Ambalaj Şekli	Packing Type	Kutu - Box
Adet / m	Quantity / m	120 m
Ağırlık	Weight	20,465 kg
m ³ /	Volume	0,09360

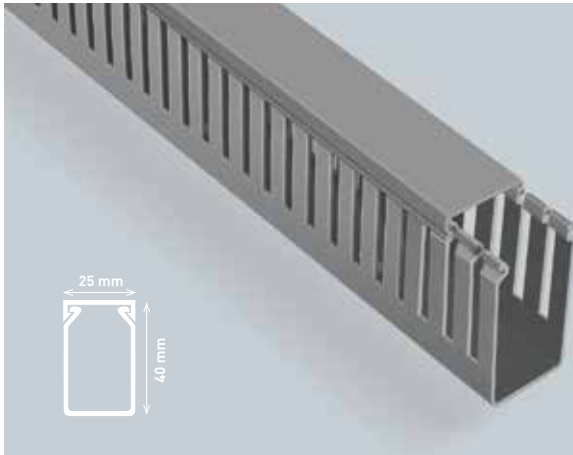
**25x40****Gri**
Grey

Ürün Kodu	Product Code	001 005 025040 20 17
Ambalaj Şekli	Packing Type	Kutu - Box
Adet / m	Quantity / m	80 m
Ağırlık	Weight	18,864 kg
m ³ /	Volume	0,09600

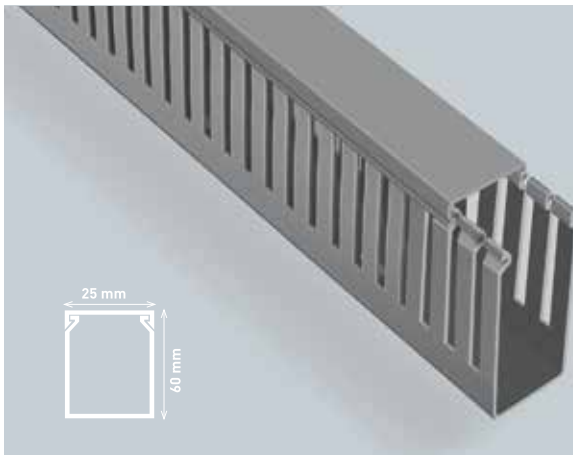
**25x60****Gri**
Grey

Ürün Kodu	Product Code	001 005 025060 20 17
Ambalaj Şekli	Packing Type	Kutu - Box
Adet / m	Quantity / m	80 m
Ağırlık	Weight	32,960 kg
m ³ /	Volume	0,14400

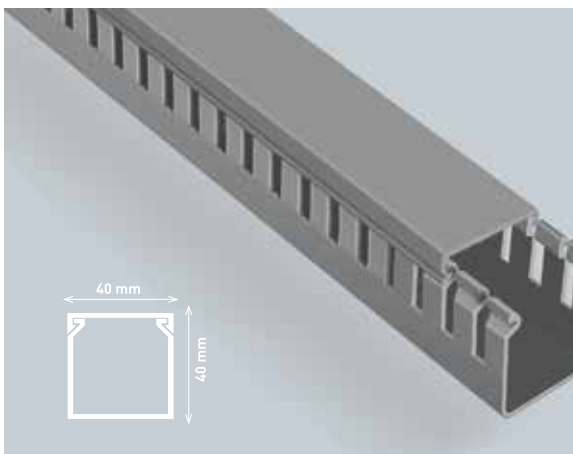
**40x40****Gri**
Grey

Ürün Kodu	Product Code	001 005 040040 20 17
Ambalaj Şekli	Packing Type	Kutu - Box
Adet / m	Quantity / m	50 m
Ağırlık	Weight	15,375 kg
m ³ /	Volume	0,10000

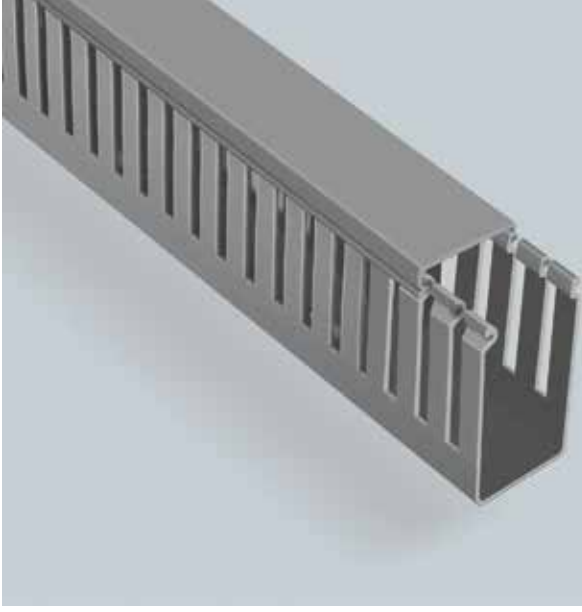
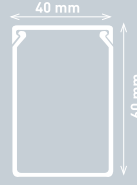
**40x60****Gri**
Grey

Ürün Kodu	Product Code	001 005 040060 20 17
Ambalaj Şekli	Packing Type	Kutu - Box
Adet / m	Quantity / m	48 m
Ağırlık	Weight	19,680 kg
m ³ /	Volume	0,14400

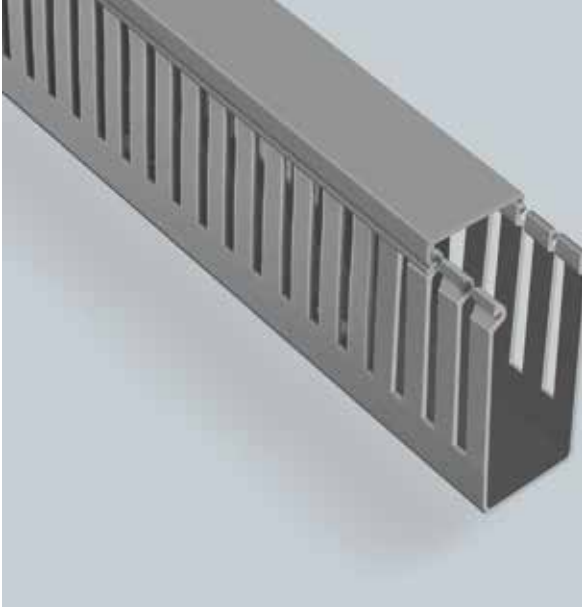
**40x80****Gri**
Grey

Ürün Kodu	Product Code	001 005 040080 20 17
Ambalaj Şekli	Packing Type	Kutu - Box
Adet / m	Quantity / m	36 m
Ağırlık	Weight	21,706 kg
m ³ /	Volume	0,14400

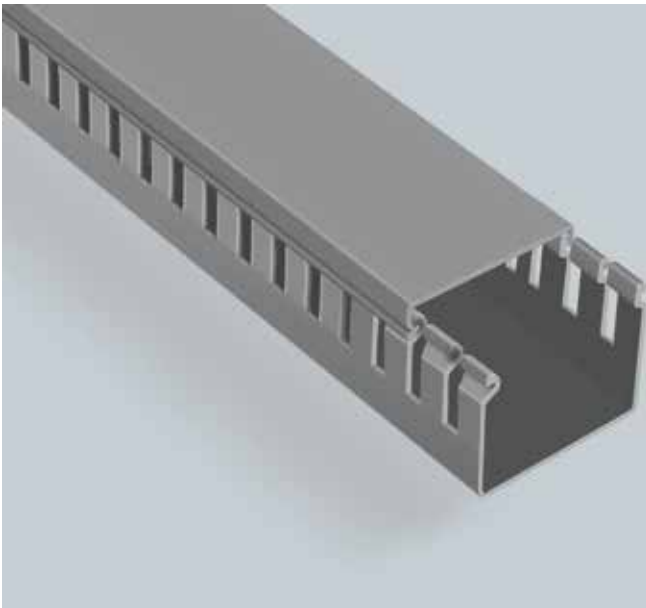
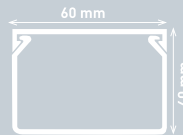
**60x40****Gri**
Grey

Ürün Kodu	Product Code	001 005 060040 20 17
Ambalaj Şekli	Packing Type	Kutu - Box
Adet / m	Quantity / m	48 m
Ağırlık	Weight	21,672 kg
m ³ /	Volume	0,14400

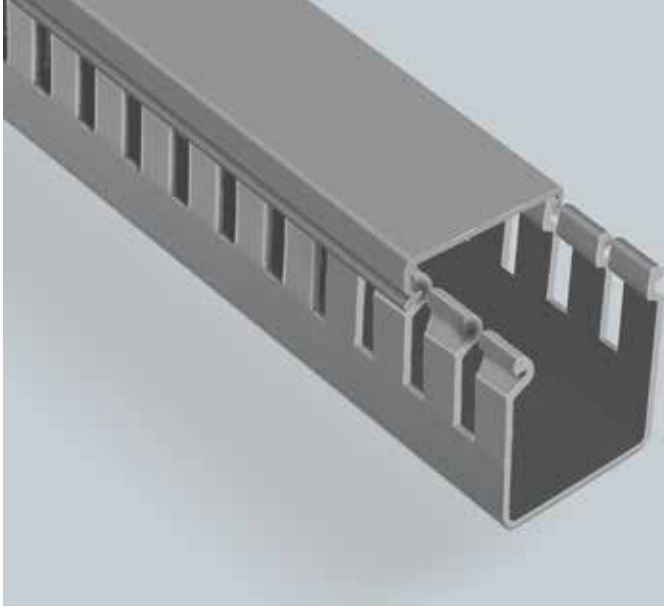
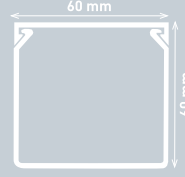
**60x60****Gri**
Grey

Ürün Kodu	Product Code	001 005 060060 20 17
Ambalaj Şekli	Packing Type	Kutu - Box
Adet / m	Quantity / m	32 m
Ağırlık	Weight	17,440 kg
m ³ /	Volume	0,14400

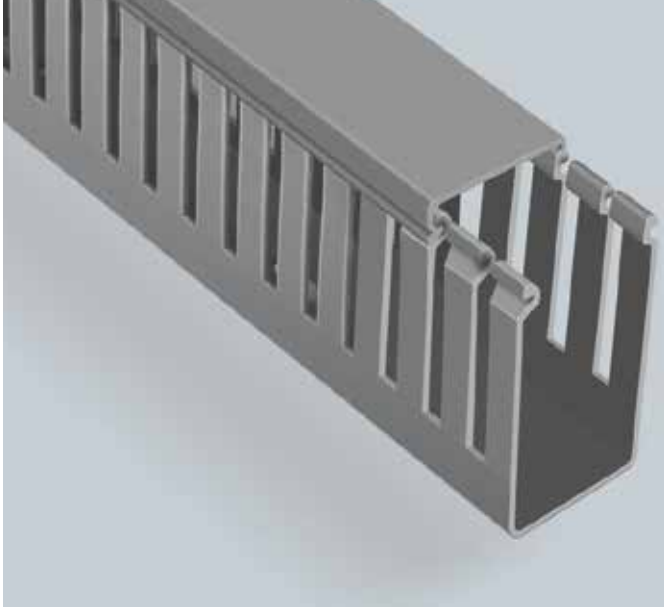
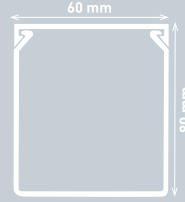
**60x80****Gri**
Grey

Ürün Kodu	Product Code	001 005 060080 20 17
Ambalaj Şekli	Packing Type	Kutu - Box
Adet / m	Quantity / m	24 m
Ağırlık	Weight	15,120 kg
m ³ /	Volume	0,11520

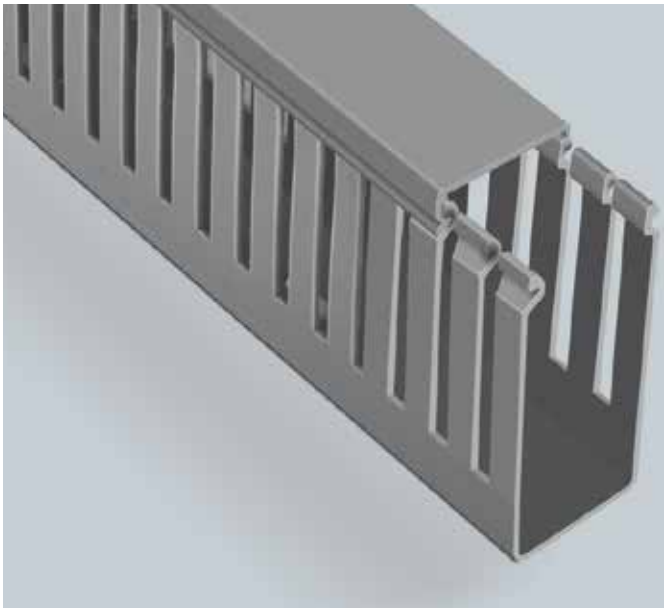
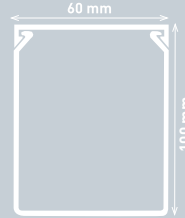
**60x100****Gri**
Grey

Ürün Kodu	Product Code	001 005 060100 20 17
Ambalaj Şekli	Packing Type	Kutu - Box
Adet / m	Quantity / m	16 m
Ağırlık	Weight	11,680 kg
m ³ /	Volume	0,09600

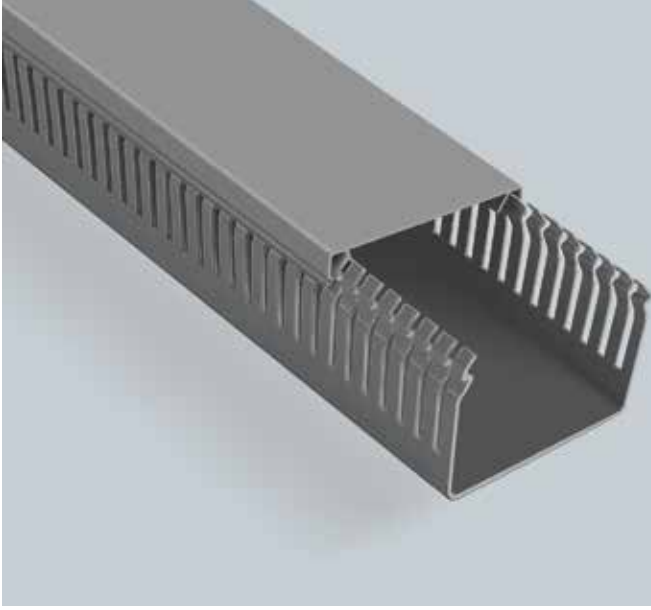
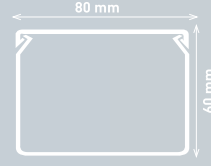
**80x60****Gri**
Grey

Ürün Kodu	Product Code	001 005 080060 20 17
Ambalaj Şekli	Packing Type	Kutu - Box
Adet / m	Quantity / m	24 m
Ağırlık	Weight	16,030 kg
m ³ /	Volume	0,14400

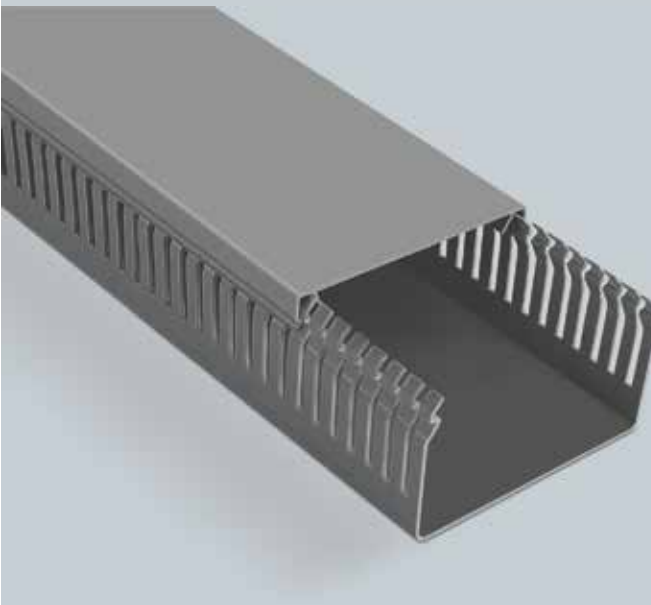
**100x60****Gri**
Grey

Ürün Kodu	Product Code	001 005 100060 20 17
Ambalaj Şekli	Packing Type	Kutu - Box
Adet / m	Quantity / m	16 m
Ağırlık	Weight	13,590 kg
m ³ /	Volume	0,14400

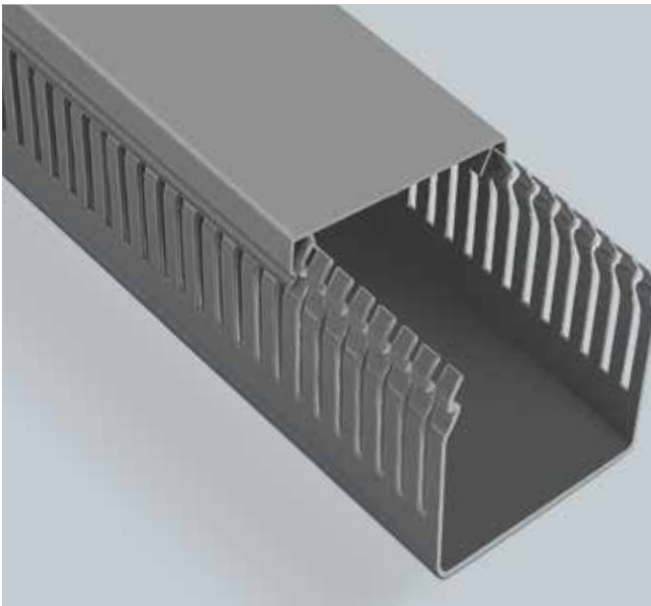
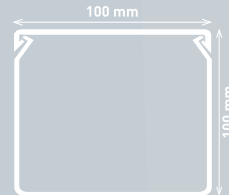
**100x100****Gri**
Grey

Ürün Kodu	Product Code	001 005 100100 20 17
Ambalaj Şekli	Packing Type	Kutu - Box
Adet / m	Quantity / m	8 m
Ağırlık	Weight	10,622 kg
m ³ /	Volume	0,07680



SANAYİ ÜRÜN GRUBU
INDUSTRIAL PRODUCT
GROUP

SANAYİ FİŞ - PRİZ GRUBU

PLUG - SOCKET GROUP

1x16A MONOFAZE	Kod Code	Açıklama Description	Ambalaj Packing	Adet Quantity	Ağırlık Weight	Hacim Volume
	010 083 300028	MUT-28 1x16 A. MONOFAZE TOPRAKLI ERKEK FİŞ (DÜZ) 1x16 A. MON.PHASE EARTHED PLUG	Kutu Pack	50	4,000 kg	0,01673
	010 083 300029	MUT-29 1x16 A. MONOFAZE TOPRAKLI DİŞİ FİŞ 1x16 A. MON.PHASE EARTHED SOCKET	Kutu Pack	30	3,650 kg	0,01673
	010 083 500296	MUT-296 1x16 A. MONOFAZE TOPRAKLI DUVAR PRİZİ 1x16 A. MON.PHASE EARTHED WALL SOCKET	Kutu Pack	24	2,695 kg	0,01673
	010 083 500292	MUT-292 1x16 A. MONOFAZE 2'Lİ TOPRAKLI GRUP RİZ 1x16 A. MON.PHASE 2 GANG EARTHED GROUP SOCKET	Kutu Pack	12	3,298 kg	0,01673
	010 083 501292	MUT-292A 1x16 A. MONOFAZE 2'Lİ TOPRAKLI GRUP PRİZ ANAHTARLI 1x16 A. MON.PHASE 2 GANG EARTHED GROUP SOCKET (WITH SWITCH)	Kutu Pack	12	3,888 kg	0,01673
	010 083 501293	1X16 A. MONOFAZE 3'LÜ GR.PRİZ ANAHTARLI 10/80 1X16 A. MON.PHASE 3 GANG GROUP SOCKET (WITH SWITCH) 10/80	Kutu Pack	10	3,240 kg	0,01673
	010 083 500293	MUT-293 1x16 A. MONOFAZE 3'LÜ TOPRAKLI GRUP RİZ 1x16 A. MON.PHASE 3 GANG EARTHED GROUP SOCKET	Kutu Pack	12	4,368 kg	0,01673

SANAYİ FİŞ - PRİZ GRUBU

PLUG - SOCKET GROUP

1x16A MONOFAZE	Kod Code	Açıklama Description	Ambalaj Packing	Adet Quantity	Ağırlık Weight	Hacim Volume
	010 083 500298	MUT-298 MONOFAZE TOPRAKLI PANO PRİZİ MON.PHASE EARTHED PANEL SOCKET	Kutu Pack	40	1,954 kg	0,01673
	010 083 501297	MUT-298U MONOFAZE UPS TOPRAKLI PANO PRİZİ MON.PHASE EARTHED UPS PANEL SOCKET	Kutu Pack	30	1,663 kg	0,00951
	010 083 500297	MUT-297 MONOFAZE DUVAR PRİZİ (PLASTİK) MON.PHASE WALL SOCKET (PLASTIC)	Kutu Pack	30	2,394 kg	0,01673
	010 083 500299	MUT-299 MONOFAZE MAKİNA PRİZİ MON.PHASE AUTOMATION SOCKET	Kutu Pack	20	2,564 kg	0,01673
	010 083 502910	MUT-2910 MONOFAZE DUVAR PRİZİ MON.PHASE WALL SOCKET	Kutu Pack	15	2,723 kg	0,01673

SANAYİ FİŞ - PRİZ GRUBU

PLUG - SOCKET GROUP

3x16A TRİFAZE	Kod Code	Açıklama Description	Ambalaj Packing	Adet Quantity	Ağırlık Weight	Hacim Volume
	010 083 400060	MUT-60 3x16 A. TRİFAZE ERKEK FİŞ 3x16 A. THREE PHASE PLUG	Kutu Pack	30	4,638 kg	0,01673
	010 083 400061	MUT-61 3x16 A. TRİFAZE SEYYAR DİŞİ FİŞ 3x16 A. THREE PHASE PORTABLE SOCKET	Kutu Pack	25	4,825 kg	0,01673
	010 083 400062	MUT-62 3x16 A. TRİFAZE DUVAR PRİZİ 3x16 A. THREE PHASE WALL SOCKET	Kutu Pack	20	4,900 kg	0,01673
	010 083 400063	MUT-63 3x16 A. TRİFAZE DUVAR PRİZİ (PLASTİK) 3x16 A. THREE PHASE WALL SOCKET (PLASTIC)	Kutu Pack	12	2,460 kg	0,01673
	010 083 400064	MUT-64 3x16 A. TRİFAZE MAKİNA PRİZİ (PLASTİK) 3x16 A. THREE PHASE AUTOMATION SOCKET (PLASTIC)	Kutu Pack	20	3,000 kg	0,01673

MUTLUSAN CEE NORM SANAYİ TİPİ FİŞ VE PRİZ GRUBU

PLUG - SOCKET GROUP

CEE NORM	Kod Code	Açıklama Description	Ambalaj Packing	Adet Quantity	Ağırlık Weight	Hacim Volume
	010 083 000516	MUT-101 CEE NORM 5x16 A. DÜZ FİŞ 5x16 A. FLAT PLUG	Kutu Pack	16	2,720 kg	0,01673
	010 083 010516	MUT-102 CEE NORM 5x16 A. UZATMA PRİZİ 5x16 A. EXTENSION PLUG	Kutu Pack	15	3,105 kg	0,01673
	010 083 020516	MUT-103 CEE NORM 5x16 A. MAKİNA PRİZİ 5x16 A. MACHINE SOCKET	Kutu Pack	20	3,750 kg	0,01673
	010 083 030516	MUT-104 CEE NORM 5x16 A. DUVAR PRİZİ 5x16 A. WALL PLUG	Kutu Pack	8	1,360 kg	0,01673
	010 083 000532	MUT-201 CEE NORM 5x32 A. DÜZ FİŞ 5x32 A. FLAT PLUG	Kutu Pack	15	2,550 kg	0,01673
	010 083 010532	MUT-202 CEE NORM 5x32 A. UZATMA PRİZİ 5x16 A. EXTENSION PLUG	Kutu Pack	14	2,898 kg	0,01673
	010 083 020532	MUT-203 CEE NORM 5x32 A. MAKİNA PRİZİ 5x32 A. MACHINE SOCKET	Kutu Pack	14	2,625 kg	0,01673
	010 083 030532	MUT-204 CEE NORM 5x32 A. DUVAR PRİZİ 5x32 A. WALL PLUG	Kutu Pack	8	1,360 kg	0,01673

SANAYİ FİŞ - PRİZ GRUBU

PLUG - SOCKET GROUP

3x25A TRİFAZE	Kod Code	Açıklama Description	Ambalaj Packing	Adet Quantity	Ağırlık Weight	Hacim Volume
	010 083 400030	MUT-30 3x25 A. TRİFAZE ERKEK FİŞ 3x25 A. THREE PHASE PLUG	Kutu Pack	30	3,525 kg	0,01673
	010 083 400031	MUT-31 3x25 A. TRİFAZE SEYYAR DİŞİ FİŞ 3x25 A. THREE PHASE PORTABLE SOCKET	Kutu Pack	25	4,258 kg	0,01673
	010 083 600315	MUT-315 3x25 A. TRİFAZE DUVAR PRİZİ 3x25 A. THREE PHASE WALL SOCKET	Kutu Pack	24	4,140 kg	0,01673
	010 083 400319	MUT-19 3x25 A. TRİFAZE DUVAR PRİZİ (PLASTİK) 3x25 A. THREE PHASE WALL SOCKET (PLASTIC)	Kutu Pack	15	2,730 kg	0,01673
	010 083 400318	MUT-318 3x25 A. TRİFAZE MAKİNA PRİZİ (PLASTİK) 3x25 A. THREE PHASE AUTOMATION SOCKET (PLASTIC)	Kutu Pack	20	2,530 kg	0,01673
	010 083 600311	MUT-311 1 TRİFAZE + 1 MONOFAZE 2'Lİ GRUP PRİZ 1 THREE PHASE + 1 MON.PHASE 2 GANG GROUP SOCKET	Kutu Pack	10	4,050 kg	0,01673
	010 083 600312	MUT-312 TRİFAZE 2'Lİ GRUP PRİZ THREE PHASE 2 GANG GROUP SOCKET	Kutu Pack	10	4,670 kg	0,01673
	010 083 600313	MUT-313 TRİFAZE 3'LÜ GRUP PRİZ THREE PHASE 3 GANG GROUP SOCKET	Kutu Pack	10	5,750 kg	0,01673

SANAYİ FİŞ - PRİZ GRUBU

PLUG - SOCKET GROUP

1x16A MONOFAZE	Kod Code	Açıklama Description	Ambalaj Packing	Adet Quantity	Ağırlık Weight	Hacim Volume
	010 083 600316	MUT-316 2 TRİFAZE + 1 MONOFAZE 3'LÜ GRUP PRİZ 2 THREE PHASE + 1 MON.PHASE 3 GANG GROUP SOCKET	Kutu Pack	10	5,390 kg	0,01673
	010 083 600317	MUT-317 1 TRİFAZE + 2 MONOFAZE 3'LÜ GRUP PRİZ 1 THREE PHASE + 2 MON.PHASE 3 GANG GROUP SOCKET	Kutu Pack	10	5,740 kg	0,01673
3x32A TRİFAZE	Kod Code	Açıklama Description	Ambalaj Packing	Adet Quantity	Ağırlık Weight	Hacim Volume
	010 083 400070	MUT-70 3x32 A. TRİFAZE ERKEK FİŞ 3x32 A. THREE PHASE PLUG	Kutu Pack	20	4,400 kg	0,01673
	010 083 400071	MUT-71 3x32 A. TRİFAZE SEYYAR DİŞİ FİŞ 3x32 A. THREE PHASE PORTABLE SOCKET	Kutu Pack	15	3,480 kg	0,01673
	010 083 400072	MUT-72 3x32 A. TRİFAZE DUVAR PRİZİ 3x32 A. THREE PHASE WALL SOCKET	Kutu Pack	20	6,100 kg	0,01673
	010 083 400073	MUT-73 3x32 A. TRİFAZE DUVAR PRİZİ (PLASTİK) 3x32 A. THREE PHASE WALL SOCKET (PLASTIC)	Kutu Pack	12	2,587 kg	0,01673
	010 083 400074	MUT-374 3x32 A. TRİFAZE MAKİNA PRİZİ (PLASTİK) 3x32 A. THREE PHASE AUTOMATION SOCKET (PLASTIC)	Kutu Pack	20	3,200 kg	0,01673













SİNYAL VE KUMANDA BUTONLARI

SIGNAL AND CONTROL BUTTONS

	Kod Code	Açıklama Description	Ambalaj Packing	Adet Quantity	Ağırlık Weight	Hacim Volume	Renk Color
	010 090 010001	10mm Sinyal Armatürü 10mm Signal Luminaire Neon Lamp - 220V Silikon Kablolü / Silicon Cable	Kutu Pack	100	0.30 Kg	0.001	<ul style="list-style-type: none"> ● Kırmızı / Red ● Yeşil / Green ● Sarı / Yellow ● Mavi / Blue ● Beyaz / White
	010 090 010005	14mm Sinyal Armatürü 14mm Signal Luminaire 12 V - Neon Lamp	Kutu Pack	50	0.340 Kg	0.001	<ul style="list-style-type: none"> ● Kırmızı / Red ● Yeşil / Green ● Sarı / Yellow ● Mavi / Blue ● Beyaz / White
	010 090 010006	24 V					
	010 090 010007	220 V					
	010 090 010008	22mm Sinyal Armatürü 22mm Signal Luminaire 12 V - Neon Lamp	Kutu Pack	24	0.46 Kg	0.001	<ul style="list-style-type: none"> ● Kırmızı / Red ● Yeşil / Green ● Sarı / Yellow ● Mavi / Blue ● Beyaz / White
	010 090 010009	24 V					
	010 090 010010	220 V					
	010 090 010002	Ba9s Duylü Ledli 22mm Sinyal Armatürü (24V-220V) 22 mm Ba9s Signal Luminaire with lamp base and LED light (24V-220V)	Kutu Pack	24	0.55 Kg	0.001	<ul style="list-style-type: none"> ● Kırmızı / Red ● Yeşil / Green ● Sarı / Yellow ● Mavi / Blue ● Beyaz / White
	010 090 010003	Ba9s Duylü Neon 22mm Sinyal Armatürü (24V-220V) 22 mm Ba9s Signal Luminaire with lamp base and Neon light (24V-220V)					
	010 090 010004	Ba9s Ledli Işık Soketli Adaptörlü 22mm Sinyal Armatürü 22 mm Ba9s Signal Luminaire with lamp base, LED light socket	Kutu Pack	20	0.60 Kg	0.002	<ul style="list-style-type: none"> ● Kırmızı / Red ● Yeşil / Green ● Sarı / Yellow ● Mavi / Blue ● Beyaz / White
	010 111 070002	Led'li Buzzer Buzzer with LED 24 V	Kutu Pack	-	-	-	
	010 111 070001	220 V					
	010 111 070004	Buzzer Buzzer 24 V					
	010 111 070003	220 V					
	010 090 040001	Yaylı Start Butonu Spring Start Button	Kutu Pack	20	0.56 Kg	0.002	<ul style="list-style-type: none"> ● Yeşil / Green ● Sarı / Yellow ● Mavi / Blue ● Beyaz / White
	010 090 040002	Yaylı Stop Butonu Spring Stop Button					

SİNYAL VE KUMANDA BUTONLARI

SIGNAL AND CONTROL BUTTONS

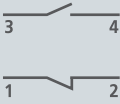
	Açıklama Description	Kontakt Contact	Devre Circuit	Ambalaj Packing	Adet Quantity	Ağırlık Weight	Hacim Volume	Renk Color
 010 090 050004	Ba9s Neon Ampüllü Yaylı Işıklı Start Butonu Ba9s Illuminated Spring Loaded Start Button with Neon Lamp	1 N / A 1 N/O		Kutu Pack	20	0.80 Kg	0.003	● Yeşil / Green ● Sarı / Yellow ● Mavi / Blue ● Beyaz / White
 010 090 050006	Ba9s Neon Ampüllü Yaylı Işıklı Stop Butonu Ba9s Illuminated Spring Loaded Stop Button with Neon Lamp	1 N / A 1 N/O		Kutu Pack	20	0.82 Kg	0.002	● Kırmızı / Red
 010 090 050003	Ba9s Ledli Yaylı Işıklı Start Butonu Ba9s Illuminated Spring Loaded Start Button with LED	1 N / A 1 N/O		Kutu Pack	20	0.80 Kg	0.001	● Yeşil / Green ● Sarı / Yellow ● Mavi / Blue ● Beyaz / White
 010 090 050005	Ba9s Ledli Yaylı Işıklı Stop Butonu Ba9s Illuminated Spring Loaded Stop Button with LED	1 N / A 1 N/O		Kutu Pack	20	0.80 Kg	0.001	
010 090 040003	Yaylı Mantar Kafa Buton Start Spring Loaded Mushroom Shaped Start Button			Kutu Pack	12	0.53 Kg	0.001	● Yeşil / Green ● Siyah / Black
 010 090 040005	Yaylı Mantar Kafa Buton Stop Spring Loaded Mushroom Shaped Stop Button				12	0.54 Kg	0.001	● Kırmızı / Red
010 090 030003	Ba9s Ledli Işıklı Seçici Buton 0-1 Ba9s Illuminated Selector Button with LED 0-1			Kutu Pack	12	0.52 Kg	0.001	● Yeşil / Green
 010 090 030004	Ba9s Ledli Işıklı Seçici Buton 11-0-1 Ba9s Illuminated Spring Loaded Stop Button with LED 11-0-1				12	0.60Kg	0.001	● Yeşil / Green
 010 090 020002	Eski Tip Start-Stop Butonu Çift Kontak Vintage Start-Stop Button Double Contact			Kutu Pack	20	0.80 Kg	0.002	● Kırmızı / Red ● Yeşil / Green ● Sarı / Yellow ● Mavi / Blue ● Beyaz / White

SİNYAL VE KUMANDA BUTONLARI

SIGNAL AND CONTROL BUTTONS

	Açıklama Description	Kontakt Contact	Devre Circuit	Ambalaj Packing	Adet Quantity	Ağırlık Weight	Hacim Volume	Renk Color
	Eski Tip Start Butonu Tek Kontakt Vintage Start Button Single Contact		$\left. \begin{array}{l} 4 \\ \\ \\ 3 \end{array} \right\}$	Kutu Pack	20	0.80 Kg	0.002	<ul style="list-style-type: none"> ● Yeşil / Green ● Sarı / Yellow ● Mavi / Blue ● Beyaz / White
010 090 020001								
	Eski Tip Stop Butonu Tek Kontakt Vintage Stop Button Single Contact		$\left. \begin{array}{l} 2 \\ \\ \\ 1 \end{array} \right\}$	Kutu Pack	20	0.70 Kg	0.002	<ul style="list-style-type: none"> ● Kırmızı / Red
010 090 020003								
	Acil Stop Butonu Emergency Stop Button Ø30	1 N / K 1 N / C	$\left. \begin{array}{l} 2 \\ \\ \\ 1 \end{array} \right\}$	Kutu Pack	12	0.50 Kg	0.001	<ul style="list-style-type: none"> ● Kırmızı / Red
010 090 050001								
	Acil Stop Butonu Emergency Stop Button Ø40		$\left. \begin{array}{l} 2 \\ \\ \\ 1 \end{array} \right\}$	Kutu Pack	12	0.54 Kg	0.001	<ul style="list-style-type: none"> ● Kırmızı / Red
010 090 050002								
	Anahtarlı Acil Stop Butonu Emergency Stop Button with key Ø40	1 N / K 1 N / C	$\left. \begin{array}{l} 2 \\ \\ \\ 1 \end{array} \right\}$	Kutu Pack	12	0.88 Kg	0.001	<ul style="list-style-type: none"> ● Kırmızı / Red
010 090 050007								
	Yaylı İkiz Buton Spring-Loaded Double Button	1 N / A 1 N / O 1 N / K 1 N / C	$\left. \begin{array}{l} 4 \\ \\ \\ 3 \end{array} \right\} \left. \begin{array}{l} 2 \\ \\ \\ 1 \end{array} \right\}$	Kutu Pack	14	0.59 Kg	0.002	<ul style="list-style-type: none"> ● Kırmızı / Red ● Yeşil / Green
010 090 040007								

SİNYAL VE KUMANDA BUTONLARI

SIGNAL AND CONTROL BUTTONS

	Açıklama Description	Kontakt Contact	Devre Circuit	Ambalaj Packing	Adet Quantity	Ağırlık Weight	Hacim Volume	Renk Color
	Yaylı Işıklı İkiz Buton Spring-Loaded Illuminated Double Button	1 N / A 1 N / O 1 N / K 1 N / C		Kutu Pack	14	0.56 Kg	0.001	● Kırmızı / Red ● Yeşil / Green
	Seçici Buton Selector Button O-I Ö-I	1 N / A 1 N / O		Kutu Pack	12	0.39 Kg	0.001	● Siyah / Black
	Anahtarlı Seçici Buton Selector Button with Key O-I Ö-I	1 N / A 1 N / O		Kutu Pack	12	0.65 Kg	0.001	● Siyah / Black
	Seçici Buton Selector Button II-O-I İİ-Ö-I	2 N / A 2 N / O		Kutu Pack	12	0.52 Kg	0.001	● Siyah / Black
	Anahtarlı Seçici Buton Selector Button with Key II-O-I İİ-Ö-I	2 N / A 2 N / O		Kutu Pack	12	0.77 Kg	0.001	● Siyah / Black
	Ba9s Neon Ampullü Işıklı Seçici Buton Illuminated Selector Button with Ba9s Neon Lamp O-I Ö-I	1 N / A 1 N / O		Kutu Pack	12	0.52 Kg	0.001	● Yeşil / Green

SİNYAL VE KUMANDA BUTONLARI

SIGNAL AND CONTROL BUTTONS

	Açıklama Description	Kontakt Contact	Devre Circuit	Ambalaj Packing	Adet Quantity	Ağırlık Weight	Hacim Volume	Renk Color
 010 090 030006	Işıklı Seçici Buton Illuminated Selector Button II-O-I II-O-I	2 N / A 2 N / O		Kutu Pack	12	0.62 Kg	0.001	● Yeşil / Green
 010 091 020002	Yön İşaretili Start Butonu Start Button With Direction Marker			Kutu Pack	20	0.58 Kg	0.002	
 010 093 000003	Acil Durdurma Etiket Emergency Stop Tag Ø60mm			Kutu Pack	50	0.07 Kg	0.0001	● Sarı / Yellow
 010 093 000001	Silikon Toz Kılıfı Silicon Dustsheet			Kutu Pack	50	0.10 Kg	0.001	● Şeffaf / Lens
 010 090 050008	Emniyet Basma Düğmesi Muhafazası Safety Push Button Housing			Kutu Pack	50	0.23 Kg	0.002	● Sarı / Yellow
 010 093 000002	Buton Etiket Button Tag			Kutu Pack	50	0.08Kg	0.004	● Siyah / Black
 010 093 000004	Yedek Kontakt Blok Reserve Contact Block			Kutu Pack	50	0.55 Kg	0.002	● Kırmızı / Red ● Yeşil / Green
 010 093 000005	Işık Soketi Light Socket			Kutu Pack	50	0.47 Kg	0.002	

ETANJ BUTON KUTULARI

WATERPROOF BUTTON BOXES

	Açıklama Description	Ambalaj Packing	Adet Quantity	Ağırlık Weight	Hacim Volume	Renk Color
 010 091 010001	1'li Etanj Buton Kutusu Water Proof Button Box, Single (New Model) Ø 22mm IP 54 Ø 25mm	Kutu Pack	24	1,992 kg	0,01216	 Sarı-Siyah / Yellow-Black  Gri-Siyah / Grey-Black
 010 091 010002	2'li Etanj Buton Kutusu Water Proof Button Box, Double (New Model) Ø 22mm IP 54 Ø 25mm	Kutu Pack	18	2,178 kg	0,01216	 Sarı-Siyah / Yellow-Black  Gri-Siyah / Grey-Black
 010 091 010003	3'lü Etanj Buton Kutusu Water Proof Button Box, Triple (New Model) Ø 22mm IP 54 Ø 25mm	Kutu Pack	12	1,944 kg	0,01216	 Sarı-Siyah / Yellow-Black  Gri-Siyah / Grey-Black
 010 091 010004	4'lü Etanj Buton Kutusu Water Proof Button Box, Quadruple (New Model) Ø 22mm IP 54 Ø 25mm	Kutu Pack	10	1,880 kg	0,01216	 Sarı-Siyah / Yellow-Black  Gri-Siyah / Grey-Black
 010 091 020001	Asansör Revizyon Kutusu Elevator Revision Box	Kutu Pack	6	1,938 kg	0,01216	 Sarı-Siyah / Yellow-Black  Gri-Siyah / Grey-Black
 010 090 050009	Tekli Acil Stoplu Kutu Box Emergency Stop, Single	Kutu Pack	18	2,250 kg	0,00120	 Sarı-Siyah / Yellow-Black  Gri-Siyah / Grey-Black

VİNÇ KUMANDA BUTONLARI

CRANE CONTROL BUTTONS

	Açıklama Description	Kontakt Contact	Ambalaj Packing	Adet Quantity	Ağırlık Weight	Hacim Volume
010 092 000001	2'li Vinç Kutusu (Tek Hızlı) Crane Box, Double (Single Speed) IP 65	1 N / A 1 N / O 1 N / K 1 N / C	Kutu Pack	1	0,528 kg	0,00355
010 092 000002	3'lü Vinç Kutusu (Tek Hızlı) Crane Box, Triple (Single Speed) IP 65	1 N / A 1 N / O 1 N / K 1 N / C	Kutu Pack	1	0,560 kg	0,00355
010 092 000003	4'lü Vinç Kutusu (Tek Hızlı) Crane Box, Quadruple (Single Speed) IP 65	1 N / A 1 N / O 1 N / K 1 N / C	Kutu Pack	1	0,662 kg	0,00355
010 092 000004	5'li Vinç Kutusu (Tek Hızlı) Crane Box, Quintet (Single Speed) IP 65	1 N / A 1 N / O 1 N / K 1 N / C	Kutu Pack	1	0,662 kg	0,00355
010 092 000005	6'li Vinç Kutusu (Tek Hızlı) Crane Box, Sextet (Single Speed) IP 65	1 N / A 1 N / O 1 N / K 1 N / C	Kutu Pack	1	0,805 kg	0,00355
010 092 000006	7'li Vinç Kutusu (Tek Hızlı) Crane Box, Septet (Single Speed) IP 65	1 N / A 1 N / O 1 N / K 1 N / C	Kutu Pack	1	0,875 kg	0,00355







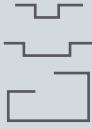

SÜPER ETANJ RAKORLAR

SUPER WATERPROOF CABLE GLANDS

	Kod Code	Açıklama Description	Kablo Çapı (min.-max.) Cable Diameter (min.-max.)	Ambalaj Packing	Adet Quantity	Ağırlık Weight	Hacim Volume
	010 097 000007	PG-7	3,0 mm - 6,5 mm	Kutu Pack	450	2,475 kg	0,00773
	010 097 000009	PG-9	4,0 mm - 8,0 mm	Kutu Pack	300	2,100 kg	0,00773
	010 097 000011	PG-11	5,0 mm - 10,0 mm	Kutu Pack	200	2,000 kg	0,00773
	010 097 000135	PG-13,5	6,0 mm - 12,0 mm	Kutu Pack	175	2,100 kg	0,00773
	010 097 000016	PG-16	10,0 mm - 14,0 mm	Kutu Pack	125	2,025 kg	0,00773
	010 097 000021	PG-21	13,0 mm - 18,0 mm	Kutu Pack	75	1,725 kg	0,00773
	010 097 000029	PG-29	18,0 mm - 25,0 mm	Kutu Pack	40	1,680 kg	0,00773
	010 097 000036	PG-36	22,0 mm - 32,0 mm	Kutu Pack	20	1,600 kg	0,00773
	010 097 000042	PG-42	32,0 mm - 38,0 mm	Kutu Pack	15	1,395 kg	0,00773
	010 097 000048	PG-48	34,0 mm - 44,0 mm	Kutu Pack	12	1,356 kg	0,00773

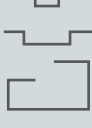

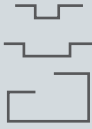



RAY KLEMENSLER

RAIL TERMINAL BLOCKS

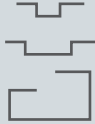
	Açıklama Description	Devre Circuit	Ambalaj Packing	Adet Quantity	Ağırlık Weight	Hacim Volume	Renk Color
	2.5mm² Ray Klemens 2.5mm ² Rail Terminal Blocks Polyamid 66 Polyamide 66		Kutu Pack	100	0,750 kg	0,00161	<ul style="list-style-type: none"> ● Kırmızı / Red ● Yeşil / Green ● Sarı / Yellow ● Mavi / Blue ● Gri / Grey ● Siyah / Black
	4mm² Ray Klemens 4mm ² Rail Terminal Blocks Polyamid 66 Polyamide 66		Kutu Pack	100	1,400 kg	0,00161	<ul style="list-style-type: none"> ● Kırmızı / Red ● Yeşil / Green ● Sarı / Yellow ● Mavi / Blue ● Gri / Grey ● Siyah / Black
	6mm² Ray Klemens 6mm ² Rail Terminal Blocks Polyamid 66 Polyamide 66		Kutu Pack	100	1,600 kg	0,00246	<ul style="list-style-type: none"> ● Kırmızı / Red ● Yeşil / Green ● Sarı / Yellow ● Mavi / Blue ● Gri / Grey ● Siyah / Black
	10mm² Ray Klemens 10mm ² Rail Terminal Blocks Polyamid 66 Polyamide 66		Kutu Pack	100	2,000 kg	0,00246	<ul style="list-style-type: none"> ● Kırmızı / Red ● Yeşil / Green ● Sarı / Yellow ● Mavi / Blue ● Gri / Grey ● Siyah / Black
	16mm² Ray Klemens 16mm ² Rail Terminal Blocks Polyamid 66 Polyamide 66		Kutu Pack	30	0,990 kg	0,00161	<ul style="list-style-type: none"> ● Kırmızı / Red ● Yeşil / Green ● Sarı / Yellow ● Mavi / Blue ● Gri / Grey ● Siyah / Black

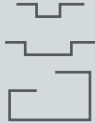
RAY KLEMENSLER

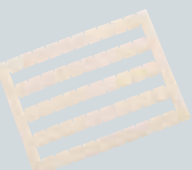
RAIL TERMINAL BLOCKS

	Açıklama Description	Devre Circuit	Ambalaj Packing	Adet Quantity	Ağırlık Weight	Hacim Volume	Renk Color
	35mm² Ray Klemens 35mm ² Rail Terminal Blocks Polyamid 66 Polyamide 66		Kutu Pack	20	1,200 kg	0,00161	<ul style="list-style-type: none"> ● Kırmızı / Red ● Yeşil / Green ● Sarı / Yellow ● Mavi / Blue ● Gri / Grey ● Siyah / Black
	Durdurucu Stopper Polyamid 66 Polyamide 66		Kutu Pack	100	0,900 kg	0,00161	<ul style="list-style-type: none"> ● Gri / Grey
	Yazılı Dekafix Dekafix with inscriptions		Kutu Pack	1	0,002 kg	0,00001	
	Yazısız Dekafix Dekafix without inscriptions		Kutu Pack	1	-	-	
	Topraklama Ray Klemensi Grounding Rail Terminal Block 010 094 010003 2,5/4 mm 010 094 010004 6/10 mm 010 094 010005 16/35 mm		Kutu Pack	100 100 30	0,700 kg 1,600 kg 0,990 kg	0,00161 0,00246 0,00161	<ul style="list-style-type: none"> ● Yeşil / Green ● Sarı / Yellow

SIKMALI TİP KABLO PAPUÇLARI (EKO SERİ)

CLAMPING TYPE CABLE TERMINAL LUGS (ECO SERIES)

	Kod Code	Açıklama Description	Ambalaj Packing	Adet Quantity	Ağırlık Weight	Hacim Volume
	123 037 000010	10 mm ²	Kutu Pack	800	3,600 kg	0,00160
	123 037 000016	16 mm ²	Kutu Pack	500	3,500 kg	0,00140
	123 037 000025	25 mm ²	Kutu Pack	350	3,150 kg	0,00140
	123 037 000035	35 mm ²	Kutu Pack	200	3,000 kg	0,00142
	123 037 000050	50 mm ²	Kutu Pack	150	3,450 kg	0,00143
	123 037 000070	70 mm ²	Kutu Pack	100	3,000 kg	0,00142
	123 037 000095	95 mm ²	Kutu Pack	70	2,800 kg	0,00140
	123 037 000120	120 mm ²	Kutu Pack	50	2,700 kg	0,00143
	123 037 000150	150 mm ²	Kutu Pack	40	3,400 kg	0,00142
	123 037 000185	185 mm ²	Kutu Pack	30	3,150 kg	0,00143
	123 037 000240	240 mm ²	Kutu Pack	24	3,120 kg	0,00143

SIRA KLEMENSLER

CONNECTOR (TERMINAL BLOCKS)

	Kod Code	Açıklama Description	Ambalaj Packing	Adet Quantity	Ağırlık Weight	Hacim Volume
	015 094 160001	Zeytin Klemens No:2 (4-6mm²) Olive - Shaped Wire Connector No: 2 (4-6 mm ²)		1000	18,000 kg	0,01000
		<ul style="list-style-type: none"> ● Kırmızı / Red ● Yeşil / Green ● Sarı / Yellow ● Mavi / Blue ● Gri / Grey ● Siyah / Black 	Kutu Pack			
	015 094 150001	Plastik Sıra Klemens No:2 (2.5-4mm²) Plastic Wire Connector No: 2 (2.5-4 mm ²)		50	1,500 kg	0,00500
	015 094 150002	Plastik Sıra Klemens No:2 (4-6mm²) Plastic Wire Connector No: 2 (4-6 mm ²)		50	2,200 kg	0,00363
	015 094 150003	Plastik Sıra Klemens No:3 (10-16mm²) Plastic Wire Connector No: 2 (10-16 mm ²)		50	3,000 kg	0,00499
	015 094 150004	Plastik Sıra Klemens No:4 (16-25mm²) Plastic Wire Connector No: 2 (16-25 mm ²)		50	3,650 kg	0,00585
	015 094 170001	Isıya Dayanıklı Sıra Klemens No:1 (2.5-4mm²) Fire-Proof Wire Connector No: 2 (2.5-4 mm ²)		50	1,600 kg	0,00500
	015 094 170002	Isıya Dayanıklı Sıra Klemens No:2 (4-6mm²) Fire-Proof Wire Connector No: 2 (4-6 mm ²)		50	2,300 kg	0,00500
	015 094 170003	Isıya Dayanıklı Sıra Klemens No:3 (10-16mm²) Fire-Proof Wire Connector No: 2 (10-16 mm ²)		50	3,150 kg	0,00500
	015 094 170004	Isıya Dayanıklı Sıra Klemens No:4 (16-25mm²) Fire-Proof Wire Connector No: 2 (16-25 mm ²)		50	4,000 kg	0,00500

RAYLAR, TOPRAKLAMA ÇUBUĞU VE BARALAR

RAILS, GROUNDING ROD AND BUSBARS

	Kod Code	Açıklama Description	Ambalaj Packing	Adet Quantity	Ağırlık Weight	Hacim Volume
	014 094 020001	Ray Taşıyıcısı Rail Carrier	Kutu Pack	150	2,700 kg	0,00600
	001 025 020100 00 00	Klemens Rayı 1 mt. Wire Connector Rail, 1 m	Kutu Pack	25	13,375 kg	0,00635
	001 025 900100 00 00	W Otomat Rayı 1 mt. Fuse Box Rail, 1 m	Kutu Pack	50	15,750 kg	0,01500
	001 025 000033 00 00	W Otomat Rayı 33 cm. Fuse Box Rail, 33 cm	Kutu Pack	50	6,358 kg	0,00500
	001 025 900100 00 00	W Otomat Rayı (Delikli) 1 mt. Fuse Box Rail (Slotted) 1 m	Kutu Pack	50	15,750 kg	0,01500
	001 025 900099 99 00	W Otomat Rayı (Delikli) (Özel Boy) Fuse Box Rail (Slotted) (Custom Size)	Kutu Pack	1 mt.	0,315 kg	0,00030
	034 025 040001	Topraklama Barası 1 mt. Grounding Busbar 1 m	Kutu Pack	40	14,400 kg	0,01200
	091 025 010001	Topraklama Çubuğu 1 mt. (Piyasa) Grounding Rod 1 m (Commercial)	Kutu Pack	25	17,625 kg	0,00250
	034 025 040004	Trif. Müşterek Bara İğne Uçlu 50 cm. Three-phase Common Busbar, Pintle Type, 50 cm.	Kutu Pack	24	6,422 kg	0,00720
	034 025 040002	Mon. Müşterek Bara İğne Uçlu 1 mt. Three-phase Common Busbar, Pintle Type, 1 m	Kutu Pack	50	10,920 kg	0,01030

DÖNER LAMBA, FLAŞÖRLÜ LAMBA VE SİRENLER

ROTATING BEACON, BLINKER BEACON AND SIRENS

	Kod Code	Açıklama Description	Renk Color
	888 111 050004	MS190 Mini Siren MS190 Mini Siren	
	888 111 050005	MS290P Plastik Siren 220V MS290P Plastic Siren 220V	
	888 111 050006	MS290M Metal Siren 220V MS290M Metallic Siren 220V	
	026 111 000001	Uçak İkaz Lambası (Ampullü) Aircraft Warning Light (with lamp)	
	026 111 000002	Uçak İkaz Lamba Sehpası Aircraft Warning Light Stand	
	026 111 010001	AS. 1 Motorlu Siren (Plastik Gövdeli) 220V, 150W AS. 1 Motorized Siren (Plastic Body) 220V, 150W	
	026 111 010002	AS. 2 Motorlu Siren (Plastik Gövdeli) 220V, 200W AS. 2 Motorized Siren (Plastic Body) 220V, 200W	
	026 111 010003	AS. 1 Motorlu Siren (Döküm Gövdeli) 220V, 150W AS. 1 Motorized Siren (Casting Body) 220V, 150W	
	026 111 010004	AS. 2 Motorlu Siren (Döküm Gövdeli) 220V, 200W AS. 2 Motorized Siren (Casting Body) 220V, 200W	
	001 111 020004 00 00	Döner Lamba 220 V Rotating Beacon, 220V	
	001 111 020001 00 00	Döner Lamba 12 V AC Rotating Beacon, 12 V AC	● Kırmızı / Red ● Sarı / Yellow ● Yeşil / Green ● Mavi / Blue
	001 111 020002 00 00	Döner Lamba 24 V AC Rotating Beacon, 24 V AC	● Kırmızı / Red ● Sarı / Yellow ● Yeşil / Green ● Mavi / Blue
	001 111 030001 00 00	Flaşörlü Lamba 12 V Blinker 12 V	● Kırmızı / Red ● Sarı / Yellow ● Yeşil / Green ● Mavi / Blue
	001 111 030002 00 00	Flaşörlü Lamba 24 V Blinker 24 V	● Kırmızı / Red ● Sarı / Yellow ● Yeşil / Green ● Mavi / Blue
	001 111 030003 00 00	Flaşörlü Lamba 220 V Blinker 220 V	● Kırmızı / Red ● Sarı / Yellow ● Yeşil / Green ● Mavi / Blue
	001 111 030003 00 11	Sabit Lamba 220 V AC Stationary Beacon 220 V AC	● Kırmızı / Red ● Sarı / Yellow ● Yeşil / Green ● Mavi / Blue

SOLAR İKAZ LAMBALARI

SOLAR WARNING LIGHTS

	Kod Code	Model Models
--	-------------	-----------------

GÜNEŞ ENERJİLİ SOLAR PANEL İKAZ LAMBALARI

SOLAR WARNING LIGHTS

	1 007 087 400106 IL-XSLR-TMK	T90 Solar İkaz Lambası ÇAKAR 12V T90 Solar Warning Lights BEACON 12 V
	2 007 087 400107 IL-XSL05-KMK	T90 Solar Kule İkaz Lambası Seti ÇAKAR 12V T90 Solar Tower Warning Lights BEACON 12 V
	3 007 087 400108 IL-XSL20M-KMK	T90 Solar Ayaklı İkaz Lambası Seti ÇAKAR 12V T90 Solar Footed Warning Lights BEACON 12 V
<ul style="list-style-type: none"> ■ Rf dalgaya yaymaz ■ Stabilize ışık çıkışı ■ 12 yıl uzun ömürlü ■ UV ışınlarına karşı dayanıklı ■ Görülebilirlik mesafesi 10 km ■ Her türlü yüzeye kolay montaj ■ Sabit, flaşör, çakar ve döner çalışma fonksiyonları ■ Foto sensör yardımıyla gece ve gündüz algılama 		<ul style="list-style-type: none"> ■ No RF radiation ■ Stabilized light output ■ 12 year long life ■ Resistant to UV rays ■ Visibility distance of 10 km ■ Easy installation on any surface ■ Continuous, flashing, strobe signal type ■ Photo help night and sensor day detection

MULTİ VE ŞARJLI İKAZ LAMBALARI

CHARGEABLE WARNING LIGHTS

	T90 MULTİ SERİ TEK GÖVDE DÖRT FARKLI ÇALIŞMA ÖZELLİĞİ T90 MULTI SERIES ONE BODY FEATURE FOUR DIFFERENT WORK	
	007 087 400101 IL-XM-T9-24K	Multi 24 VDC
	007 087 400102 IL-XM-T9-22K	Multi 220 VAC
	007 087 400103 IL-XMB-T9-24K	Multi + Buzzer 24 VAC
007 087 400104 IL-XMB-T9-22K	Multi + Buzzer 220 VAC	
T90 MULTİ SERİ TEK GÖVDE DÖRT FARKLI ÇALIŞMA ÖZELLİĞİ T90 MULTI SERIES ONE BODY FEATURE FOUR DIFFERENT WORK		
007 087 400105 IL-XJM-912V-TMK	Şarjlı, Multi + Buzzer 12 V	
<ul style="list-style-type: none"> ■ Stabilize ışık çıkışı ■ Her türlü yüzeye kolay montaj ■ Sabit, flaşör, çakar ve döner çalışma fonksiyonları 		<ul style="list-style-type: none"> ■ Stabilized light output ■ Easy installation on any surface ■ Continuous, flashing, strobe signal type

Renk Seçenekleri
Color Options



Temperature



High IP value



Shock /
Vibration
resistant



Magnetic
field proof



Power
LED Light

İKAZ LAMBALARI

WARNING LIGHTS

	Kod Code	Model Models
Ø60 SERİSİ İKAZ LAMBALARI Ø60 SERIES WARNING LIGHTS		
  <p>ÖZEL TASARIM ALÜMİNYUM GÖVDEDE POWER LED SPECIAL DESIGN ALUMINIUM BODY POWER LED</p> 	129 087 000431 IL-XPS-T6-243-A2	24V DC - Sabit / Continuous
	129 087 000432 IL-XPS-T6-223-A2	220V AC - Sabit / Continuous
	129 087 000433 IL-XPf-T6-243-A2	24V DC - Flaşörlü / Flashing
	129 087 000434 IL-XPf-T6-223-A2	220V AC - Flaşörlü / Flashing
	129 087 000435 IL-XPÇ-T6-243-A2	24V DC - Çakar / Strobe
	129 087 000436 IL-XPÇ-T6-223-A2	220V AC - Çakar / Strobe
	129 087 000412 IL-XPSB-T6-243-A2	24V DC - Sabit+Buzzer / Continuous+Buzzer
	129 087 000413 IL-XPSB-T6-223-A2	220V AC - Sabit+Buzzer / Continuous+Buzzer
	129 087 000414 IL-XPFB-T6-243-A2	24V DC - Flaşörlü+Buzzer / Flashing+Buzzer
	129 087 000415 IL-XPFB-T6-223-A2	220V AC - Flaşörlü+Buzzer / Flashing+Buzzer
	129 087 000416 IL-XPÇB-T6-243-A2	24V DC - Çakar+Buzzer / Strobe+Buzzer
	129 087 000417 IL-XPÇB-T6-223-A2	220V AC - Çakar+Buzzer / Strobe+Buzzer

Ø70 SERİSİ İKAZ LAMBALARI Ø70 SERIES WARNING LIGHTS		
<p>GENİŞ ÇALIŞMA AKIMI 12 VDC - 80 VDC EXTENSIVE WORK FLOW 12 VDC - 80 VDC</p> 	129 087 000419 IL-XS-F7-80-A2	12-80V DC - Sabit / Continuous
	129 087 000420 IL-XS-F7-22-A2	220V AC - Sabit / Continuous
	129 087 000421 IL-XF-F7-80-A2	12-80V DC - Flaşörlü / Flashing
	129 087 000422 IL-XF-F7-22-A2	220V AC - Flaşörlü / Flashing
	129 087 000423 IL-XÇ-F7-80-A2	12-80V DC - Çakar / Strobe
	129 087 000424 IL-XÇ-F7-22-A2	220V AC - Çakar / Strobe
	129 087 000425 IL-XSB-F7-80-A2	12-80V DC - Sabit / Continuous + Buzzer
	129 087 000426 IL-XSB-F7-22-A2	220V AC - Sabit / Continuous + Buzzer
	129 087 000427 IL-XFB-F7-80-A2	12-80V DC - Flaşörlü / Flashing + Buzzer
	129 087 000428 IL-XFB-F7-22-A2	220V AC - Flaşörlü / Flashing + Buzzer
	129 087 000429 IL-XÇB-F7-80-A2	12-80V DC - Çakar / Strobe + Buzzer
	129 087 000430 IL-XÇB-F7-22-A2	220V AC - Çakar / Strobe + Buzzer

Ø67 SERİSİ İKAZ LAMBALARI



Ø67 SERIES WARNING LIGHTS

	Kod Code	Çalışma Şekli Signal Type	Voltaj Voltage	Tüketim Consumptive	Ampul Lamp	Çap Diameter	Montaj Assembly
 Lens	129 087 000015 IL-XM67S-24	Sabit / Continuous	24 VAC/DC	0.9A	24 VAC/DC	67 mm	Tabana Montaj Floor Mounted
	129 087 000018 IL-XM67S-22		220 VAC	0.9A	220 VAC	67 mm	Tabana Montaj Floor Mounted
 Lens	129 087 000020 IL-XM67F-24	Flaşörlü / Flashing	24 VAC/DC	0.9A	24 VAC/DC	67 mm	Tabana Montaj Floor Mounted
	129 087 000023 IL-XM67F-22		220 VAC	0.9A	220 VAC	67 mm	Tabana Montaj Floor Mounted
 Lens	129 087 000025 IL-XM67Ç-24	Çakar / Strobe	24 VAC/DC	0.9A	24 VAC/DC	67 mm	Tabana Montaj Floor Mounted
	129 087 000028 IL-XM67Ç-22		220 VAC	0.9A	220 VAC	67 mm	Tabana Montaj Floor Mounted
 IL-X...-T6	129 087 000040 IL-XS-T6-24K	Sabit / Continuous	24V DC	0.5A	24V 5W	60 mm	Tabana Montaj Floor Mounted
	129 087 000041 IL-XS-T6-22K		220V AC	0.05A	220V 5W	60 mm	Tabana Montaj Floor Mounted
 IL-X...-T6	129 087 000043 IL-XF-T6-24K	Flaşörlü / Flashing	24V DC	0.5A	24V 5W	60 mm	Tabana Montaj Floor Mounted
	129 087 000044 IL-XF-T6-22K		220V AC	0.05A	220V 5W	60 mm	Tabana Montaj Floor Mounted
 IL-X...-T6	129 087 000046 IL-XÇ-T6-24K	Çakar / Strobe	24V AC	0.05A	24V 5W	60 mm	Tabana Montaj Floor Mounted
	129 087 000047 IL-XÇ-T6-22K		220V AC	0.05A	220V 5W	60 mm	Tabana Montaj Floor Mounted
 IL-X...-T6	129 087 000050 IL-XD-T6-24K	Döner / Rotating	24V DC	0.5A	24V 5W	60 mm	Tabana Montaj Floor Mounted
	129 087 000051 IL-XD-T6-22K		220V AC	0.05A	220V 5W	60 mm	Tabana Montaj Floor Mounted

Renk Seçenekleri / Color Options: K ● S ● Y ● M ● B ○

Ø67 SERİSİ İKAZ LAMBALARI

Ø67 SERIES WARNING LIGHTS

	Kod Code	Çalışma Şekli Signal Type	Voltaj Voltage	Tüketim Consumptive	Ampul Lamp	Çap Diameter	Montaj Assembly
 IL-X...-T6	129 087 000053 IL-XSB-T6-24K	Sabit+Buzzer Continuous+Buzzer	24V DC	0.5A	24V 5W	60 mm	Tabana Montaj Floor Mounted
	129 087 000053 IL-XSB-T6-22K		220V AC	0.05A	220V 5W	60 mm	Tabana Montaj Floor Mounted
 IL-X...-T6	129 087 000056 IL-XFB-T6-24K	Flaşörlü+Buzzer Flashing+Buzzer	24V DC	0.5A	24V 5W	60 mm	Tabana Montaj Floor Mounted
	129 087 000057 IL-XFB-T6-22K		220V AC	0.05A	220V 5W	60 mm	Tabana Montaj Floor Mounted
 IL-X...-T6	129 087 000059 IL-XÇB-VT8-24K	Çakar+Buzzer Rotating+Buzzer	24 VAC/DC	0.9A	24 VAC/DC	60 mm	Vida Bağlantı Screw Connection
	129 087 000060 IL-XÇB-VT8-22K		220V AC	0.9A	220V AC	60 mm	Vida Bağlantı Screw Connection
	129 087 000062 IL-XDB-VT8-24K	Döner+Buzzer Rotating+Buzzer	24 VAC/DC	0.9A	24 VAC/DC	60 mm	Vida Bağlantı Screw Connection
	129 087 000063 IL-XDB-VT8-22K		220V AC	0.9A	220V AC	60 mm	Vida Bağlantı Screw Connection

Ø80 SERİSİ İKAZ LAMBALARI

Ø80 SERIES WARNING LIGHTS

	Kod Code	Çalışma Şekli Signal Type	Voltaj Voltage	Tüketim Consumptive	Ampul Lamp	Çap Diameter	Montaj Assembly
 IL-X...-T6	129 087 000065 IL-XS-V8-24K	Sabit+Buzzer Continuous+Buzzer	24V DC	0.5A	24V 5W	80 mm	Vida Bağlantı Screw Connection
	129 087 000066 IL-XS-V8-22K		220V AC	0.05A	220V 5W	80 mm	Vida Bağlantı Screw Connection
 IL-X...-T6	129 087 000068 IL-XF-V8-24K	Flaşörlü+Buzzer Flashing+Buzzer	24V DC	0.5A	24V 5W	80 mm	Vida Bağlantı Screw Connection
	129 087 000069 IL-XF-V8-22K		220V AC	0.05A	220V 5W	80 mm	Vida Bağlantı Screw Connection
 IL-X...-T6	129 087 000071 IL-XÇ-V8-24K	Çakar+Buzzer Rotating+Buzzer	24V DC	0.5A	24V 5W	80 mm	Vida Bağlantı Screw Connection
	129 087 000072 IL-XÇ-V8-22K		220V AC	0.05A	220V 5W	80 mm	Vida Bağlantı Screw Connection
 IL-X...-T6	129 087 000075 IL-XD-V8-24K	Döner+Buzzer Rotating+Buzzer	24V DC	0.5A	24V 5W	80 mm	Vida Bağlantı Screw Connection
	129 087 000076 IL-XD-V8-22K		220V AC	0.05A	220V 5W	80 mm	Vida Bağlantı Screw Connection

Renk Seçenekleri / Color Options: IL-XLS-V8-12K ● IL-XLS-V8-12S ● IL-XLS-V8-12Y ● IL-XLS-V8-12M ● IL-XLS-V8-12B ○

Ø80 SERİSİ İKAZ LAMBALARI

Ø80 SERIES WARNING LIGHTS

	Kod Code	Çalışma Şekli Signal Type	Voltaj Voltage	Tüketim Consumptive	Ampul Lamp	Çap Diameter	Montaj Assembly
	129 087 000078 IL-XSB-V8-24K	Sabit+Buzzer Continuous+Buzzer	24V DC	0.5A	24V 5W	80 mm	Vida Bağlantı Screw Connection
	129 087 000079 IL-XSB-V8-22K		220V AC	0.05A	220V 5W	80 mm	Vida Bağlantı Screw Connection
	129 087 000081 IL-XFB-V8-24K	Flaşörlü+Buzzer Flashing+Buzzer	24V DC	0.5A	24V 5W	80 mm	Vida Bağlantı Screw Connection
	129 087 000082 IL-XFB-V8-22K		220V AC	0.05A	220V 5W	80 mm	Vida Bağlantı Screw Connection
	129 087 000084 IL-XÇB-V8-24K	Çakar+Buzzer Rotating+Buzzer	24 VAC/DC	0.9A	24 VAC/DC	80 mm	Vida Bağlantı Screw Connection
	129 087 000085 IL-XÇB-V8-22K		220V AC	0.9A	220V AC	80 mm	Vida Bağlantı Screw Connection
	129 087 000087 IL-XDB-V8-24K	Döner+Buzzer Rotating+Buzzer	24 VAC/DC	0.9A	24 VAC/DC	80 mm	Vida Bağlantı Screw Connection
	129 087 000088 IL-XDB-V8-22K		220V AC	0.9A	220V AC	80 mm	Vida Bağlantı Screw Connection
	129 087 000090 IL-XS-T8-24K	Sabit / Continuous	24V DC	0.5A	24V 5W	80 mm	Tabana Montaj Floor-mounted
	129 087 000091 IL-XS-T8-22K		220V AC	0.05A	220V 5W	80 mm	Tabana Montaj Floor-mounted
	129 087 000093 IL-XF-T8-24K	Flaşörlü / Flashing	24V DC	0.5A	24V 5W	80 mm	Tabana Montaj Floor-mounted
	129 087 000094 IL-XF-T8-22K		220V AC	0.05A	220V 5W	80 mm	Tabana Montaj Floor-mounted
	129 087 000096 IL-XÇ-T8-24K	Çakar / Strobe	220V AC	0.05A	220V 5W	80 mm	Tabana Montaj Floor-mounted
	129 087 000097 IL-XÇ-T8-22K		220V AC	0.05A	220V 5W	80 mm	Tabana Montaj Floor-mounted
	129 087 000100 IL-XD-T8-24K	Döner / Rotating	24V DC	0.5A	24V 5W	80 mm	Tabana Montaj Floor-mounted
	129 087 000101 IL-XD-T8-22K		220V AC	0.05A	220V 5W	80 mm	Tabana Montaj Floor-mounted
	129 087 000103 IL-XB-T8-24K	Sabit+Buzzer Continuous+Buzzer	24V DC	0.5A	24V 5W	80 mm	Tabana Montaj Floor-mounted
	129 087 000104 IL-XB-T8-22K		220V AC	0.05A	220V 5W	80 mm	Tabana Montaj Floor-mounted

Renk Seçenekleri / Color Options: K ● S ● Y ● M ● B ○



Ø80 SERİSİ İKAZ LAMBALARI





Ø80 SERIES WARNING LIGHTS

Kod Code	Çalışma Şekli Signal Type	Voltaj Voltage	Tüketim Consumptive	Ampul Lamp	Çap Diameter	Montaj Assembly	
	129 087 000106 IL-XMB-T8-24K	Multi+Buzzer Multi+Buzzer	24V DC	0.5A	24V 5W	80 mm	Tabana Montaj Floor-mounted
	129 087 000107 IL-XMB-T8-22K		220V AC	0.05A	220V 5W	80 mm	Tabana Montaj Floor-mounted
	129 087 000109 IL-XMB-T8-24K	Multi+Buzzer Multi+Buzzer	24 VAC/DC	0.9A	24 VAC/DC	80 mm	Tabana Montaj Floor-mounted
	129 087 000110 IL-XMB-T8-22K		220V AC	0.9A	220V AC	80 mm	Tabana Montaj Floor-mounted



Ø80 SERİSİ İKAZ LAMBALARI

Ø80 SERIES WARNING LIGHTS

Kod Code	Çalışma Şekli Signal Type	Voltaj Voltage	Tüketim Consumptive	Ampul Lamp	Çap Diameter	Montaj Assembly	
 	Sabit / Continuous	129 087 000115 IL-XS-VT8-24K	24V DC	0.5A	24V 5W	80 mm	Tabana Montaj Floor-mounted
		129 087 000116 IL-XS-VT8-22K	220V AC	0.05A	220V 5W	80 mm	Tabana Montaj Floor-mounted
	Flaşörlü / Flashing	129 087 000118 IL-XF-VT8-24K	24V DC	0.5A	24V 5W	80 mm	Tabana Montaj Floor-mounted
		129 087 000119 IL-XF-VT8-22K	220V AC	0.05A	220V 5W	80 mm	Tabana Montaj Floor-mounted
	Çakar / Strobe	129 087 000121 IL-XÇ-VT8-24K	24V DC	0.5A	24V 5W	80 mm	Tabana Montaj Floor-mounted
		129 087 000122 IL-XÇ-VT8-22K	220V AC	0.05A	220V 5W	80 mm	Tabana Montaj Floor-mounted
	Döner / Rotating	129 087 000125 IL-XD-VT8-24K	24V DC	0.5A	24V 5W	80 mm	Tabana Montaj Floor-mounted
		129 087 000126 IL-XD-VT8-22K	220V AC	0.05A	220V 5W	80 mm	Tabana Montaj Floor-mounted
	Sabit+Buzzer Continuous+Buzzer	129 087 000128 IL-XSB-VT8-24K	24V DC	0.5A	24V 5W	80 mm	Tabana Montaj Floor-mounted
		129 087 000129 IL-XSB-VT8-22K	220V AC	0.05A	220V 5W	80 mm	Tabana Montaj Floor-mounted
	Flaşörlü+Buzzer Flashing+Buzzer	129 087 000131 IL-XFB-VT8-24K	24V DC	0.5A	24V 5W	80 mm	Tabana Montaj Floor-mounted
		129 087 000132 IL-XFB-VT8-22K	220V AC	0.05A	220V 5W	80 mm	Tabana Montaj Floor-mounted
Çakar+Buzzer Rotating+Buzzer	129 087 000134 IL-XÇB-VT8-24K	24 VAC/DC	0.9A	24V AC/DC	80 mm	Tabana Montaj Floor-mounted	
	129 087 000135 IL-XÇB-VT8-22K	48 VAC/DC	0.9A	220V AC/DC	80 mm	Tabana Montaj Floor-mounted	
Döner+Buzzer Rotating+Buzzer	129 087 000137 IL-XDB-VT8-24K	24 VAC/DC	0.9A	24V AC/DC	80 mm	Tabana Montaj Floor-mounted	
	129 087 000138 IL-XDB-VT8-22K	48 VAC/DC	0.9A	220V AC/DC	80 mm	Tabana Montaj Floor-mounted	

Renk Seçenekleri / Color Options: K  S  Y  M  B O

T10 SERİSİ İKAZ LAMBALARI T10 SERIES WARNING LIGHTS





	Kod Code	Çalışma Şekli Signal Type	Voltaj Voltage	Tüketim Consumptive	Ampul Lamp	Çap Diameter	Montaj Assembly
 IL-X...-T10	129 087 000140 IL-XS-T10-24K	Sabit / Continuous	24V DC	0.5A	24V 5W	100 mm	Tabana Montaj Floor-mounted
	129 087 000141 IL-XS-T10-22K		220V AC	0.05A	220V 5W	100 mm	Tabana Montaj Floor-mounted
	129 087 000143 IL-XF-T10-24K	Flaşörlü / Flashing	24V DC	0.5A	24V 5W	100 mm	Tabana Montaj Floor-mounted
	129 087 000144 IL-XF-T10-22K		220V AC	0.05A	220V 5W	100 mm	Tabana Montaj Floor-mounted
	129 087 000146 IL-XÇ-T10-24K	Çakar / Strobe	24V AC	0.05A	24V 5W	100 mm	Tabana Montaj Floor-mounted
	129 087 000147 IL-XÇ-T10-22K		220V AC	0.05A	220V 5W	100 mm	Tabana Montaj Floor-mounted
 IL-X...-T10	129 087 000150 IL-XD-T10-24K	Döner / Rotating	24V DC	0.5A	24V 5W	100 mm	Tabana Montaj Floor-mounted
	129 087 000151 IL-XD-T10-22K		220V AC	0.05A	220V 5W	100 mm	Tabana Montaj Floor-mounted
	129 087 000153 IL-XSB-T10-24K	Sabit+Buzzer Continuous+Buzzer	24V DC	0.5A	24V 5W	100 mm	Tabana Montaj Floor-mounted
	129 087 000154 IL-XSB-T10-22K		220V AC	0.05A	220V 5W	100 mm	Tabana Montaj Floor-mounted
	129 087 000156 IL-XFB-T10-24K	Flaşörlü+Buzzer Flashing+Buzzer	24V DC	0.5A	24V 5W	100 mm	Tabana Montaj Floor-mounted
	129 087 000157 IL-XFB-T10-22K		220V AC	0.05A	220V 5W	100 mm	Tabana Montaj Floor-mounted
 IL-X...-T10	129 087 000159 IL-XÇB-T10-24K	Çakar+Buzzer Rotating+Buzzer	24V AC/DC	0.9A	24V AC/DC	100 mm	Tabana Montaj Floor-mounted
	129 087 000160 IL-XÇB-T10-22K		220V AC/DC	0.9A	220V AC/DC	100 mm	Tabana Montaj Floor-mounted
	129 087 000162 IL-XDB-T10-24K	Döner+Buzzer Rotating+Buzzer	24V AC/DC	0.9A	24V AC/DC	100 mm	Tabana Montaj Floor-mounted
	129 087 000163 IL-XDB-T10-22K		220V AC/DC	0.9A	220V AC/DC	100 mm	Tabana Montaj Floor-mounted

Renk Seçenekleri / Color Options: K ● S ● Y ● M ● B ○

Ø120 SERİSİ İKAZ LAMBALARI

Ø120 SERIES WARNING LIGHTS

	Kod Code	Çalışma Şekli Signal Type	Voltaj Voltage	Tüketim Consumptive	Ampul Lamp	Çap Diameter	Montaj Assembly
 IL-X...-T12	129 087 000165 IL-XS-T12-24K	Sabit / Continuous	24V DC	0.5A	24V 5W	120 mm	Tabana Montaj Floor-mounted
	129 087 000166 IL-XS-T12-22K		220V AC	0.05A	220V 5W	120 mm	Tabana Montaj Floor-mounted
	129 087 000168 IL-XF-T12-24K	Flaşörlü / Flashing	24V DC	0.5A	24V 5W	120 mm	Tabana Montaj Floor-mounted
	129 087 000169 IL-XF-T12-22K		220V AC	0.05A	220V 5W	120 mm	Tabana Montaj Floor-mounted
	129 087 000171 IL-XÇ-T12-24K	Çakar / Strobe	24V DC	0.5A	24V 5W	120 mm	Tabana Montaj Floor-mounted
	129 087 000172 IL-XÇ-T12-22K		220V AC	0.05A	220V 5W	120 mm	Tabana Montaj Floor-mounted
 IL-X...-T12	129 087 000175 IL-XD-T12-24K	Döner / Rotating	24V DC	0.5A	24V 5W	120 mm	Tabana Montaj Floor-mounted
	129 087 000176 IL-XD-T12-22K		220V AC	0.05A	220V 5W	120 mm	Tabana Montaj Floor-mounted
	129 087 000178 IL-XSB-T12-24K	Sabit+Buzzer Continuous+Buzzer	24V DC	0.5A	24V 5W	120 mm	Tabana Montaj Floor-mounted
	129 087 000179 IL-XSB-T12-22K		220V AC	0.05A	220V 5W	120 mm	Tabana Montaj Floor-mounted
	129 087 000181 IL-XFB-T12-24K	Flaşörlü+Buzzer Flashing+Buzzer	24V DC	0.5A	24V 5W	120 mm	Tabana Montaj Floor-mounted
	129 087 000182 IL-XFB-T12-22K		220V AC	0.05A	220V 5W	120 mm	Tabana Montaj Floor-mounted
 IL-X...-T12	129 087 000184 IL-XÇB-T12-24K	Çakar+Buzzer Rotating+Buzzer	24V AC/DC	0.9A	24V AC/DC	120 mm	Tabana Montaj Floor-mounted
	129 087 000185 IL-XÇB-T12-22K		220V AC/DC	0.9A	220V AC/DC	120 mm	Tabana Montaj Floor-mounted
	129 087 000187 IL-XDB-T12-24K	Döner+Buzzer Rotating+Buzzer	24V AC/DC	0.9A	24V AC/DC	120 mm	Tabana Montaj Floor-mounted
	129 087 000188 IL-XDB-T12-22K		220V AC/DC	0.9A	220V AC/DC	120 mm	Tabana Montaj Floor-mounted

Renk Seçenekleri / Color Options: K  S  Y  M  B 

Ø52 1 KATLI IŞIKLI KOLONLAR

Ø52 1-STOREY ILLUMINATED COLUMNS

	Kod Code	Çalışma Şekli Signal Type	Voltaj Voltage	Tüketim Consumptive	Ampul Lamp	Çap Diameter	Montaj Assembly
 <p>IL-X...-T5 Serisi</p>	129 087 000278 IL-XS-T5-241	Sabit / Continuous	24V	0.9A	24V AC/DC	52 mm	Tabana Montaj Floor-mounted
	129 087 000279 IL-XS-T5-221		220V	0.9A	220V AC/DC	52 mm	Tabana Montaj Floor-mounted
	129 087 000281 IL-XF-T5-241	Flaşörlü / Flashing	24V	0.9A	24V AC/DC	52 mm	Tabana Montaj Floor-mounted
	129 087 000282 IL-XF-T5-221		220V	0.9A	220V AC/DC	52 mm	Tabana Montaj Floor-mounted
	129 087 000284 IL-XÇ-T5-241	Çakar / Strobe	24V	0.9A	24V AC/DC	52 mm	Tabana Montaj Floor-mounted
	129 087 000285 IL-XÇ-T5-221		220V	0.9A	220V AC/DC	52 mm	Tabana Montaj Floor-mounted
 <p>IL-X...-T5 Buzzer Serisi</p>	129 087 000287 IL-XSB-T5-241	Sabit+Buzzer Continuous+Buzzer	24V	0.9A	24V AC/DC	52 mm	Tabana Montaj Floor-mounted
	129 087 000288 IL-XSB-T5-221		220V	0.9A	220V AC/DC	52 mm	Tabana Montaj Floor-mounted
	129 087 000290 IL-XFB-T5-241	Flaşörlü+Buzzer Flashing+Buzzer	24V	0.9A	24V AC/DC	52 mm	Tabana Montaj Floor-mounted
	129 087 000291 IL-XFB-T5-221		220V	0.9A	220V AC/DC	52 mm	Tabana Montaj Floor-mounted
	129 087 000293 IL-XÇB-T5-241	Çakar+Buzzer Rotating+Buzzer	24V	0.9A	24V AC/DC	52 mm	Tabana Montaj Floor-mounted
	129 087 000294 IL-XÇB-T5-221		220V	0.9A	220V AC/DC	52 mm	Tabana Montaj Floor-mounted





Renk Seçenekleri / Color Options: K ● S ● Y ● M ● B ○



Ø52 2 ve 3 KATLI IŞIKLI KOLONLAR

Ø52 2 and 3 STOREY ILLUMINATED COLUMNS

	Kod Code	Çalışma Şekli Signal Type	Voltaj Voltage	Tüketim Consumptive	Ampul Lamp	Çap Diameter	Montaj Assembly
 IL-X...-T5 Serisi	129 087 000296 IL-XS-T5-242	Sabit / Continuous	24V	0.9A	24V AC/DC	52 mm	Tabana Montaj Floor-mounted
	129 087 000297 IL-XS-T5-222		220V	0.9A	220V AC/DC	52 mm	Tabana Montaj Floor-mounted
	 IL-X...-T5 Buzzer Serisi	Flaşörlü / Flashing	24V	0.9A	24V AC/DC	52 mm	Tabana Montaj Floor-mounted
			129 087 000300 IL-XF-T5-222	220V	0.9A	220V AC/DC	52 mm
	 IL-X...-T5 Buzzer Serisi	Sabit+Buzzer Continuous+Buzzer	24V	0.9A	24V AC/DC	52 mm	Tabana Montaj Floor-mounted
			129 087 000303 IL-XSB-T5-222	220V	0.9A	220V AC/DC	52 mm
 IL-X...-T5 Buzzer Serisi	Flaşörlü+Buzzer Flashing+Buzzer	24V	0.9A	24V AC/DC	52 mm	Tabana Montaj Floor-mounted	
		129 087 000306 IL-XFB-T5-222	220V	0.9A	220V AC/DC	52 mm	Tabana Montaj Floor-mounted
Renk Seçenekleri / Color Options: IL-XS-T5-122 ●●							

 IL-X...-T5 Buzzer Serisi	129 087 000308 IL-XS-T5-243	Sabit / Continuous	24V	0.9A	24V AC/DC	52 mm	Tabana Montaj Floor-mounted
	129 087 000309 IL-XS-T5-223		220V	0.9A	220V AC/DC	52 mm	Tabana Montaj Floor-mounted
	 IL-X...-T5 Buzzer Serisi	Flaşörlü / Flashing	24V	0.9A	24V AC/DC	52 mm	Tabana Montaj Floor-mounted
			129 087 000312 IL-XF-T5-223	220V	0.9A	220V AC/DC	52 mm
	 IL-X...-T5 Buzzer Serisi	Sabit+Buzzer Continuous+Buzzer	24V	0.9A	24V AC/DC	52 mm	Tabana Montaj Floor-mounted
			129 087 000315 IL-XSB-T5-223	220V	0.9A	220V AC/DC	52 mm
 IL-X...-T5 Buzzer Serisi	Flaşörlü+Buzzer Flashing+Buzzer	24V	0.9A	24V AC/DC	52 mm	Tabana Montaj Floor-mounted	
		129 087 000318 IL-XFB-T5-223	220V	0.9A	220V AC/DC	52 mm	Tabana Montaj Floor-mounted
Renk Seçenekleri / Color Options: IL-XS-T5-123 ●●●							

Ø52 4 ve 5 KATLI IŞIKLI KOLONLAR

Ø52 4 and 5 STOREY ILLUMINATED COLUMNS

	Kod Code	Çalışma Şekli Signal Type	Voltaj Voltage	Tüketim Consumptive	Ampul Lamp	Çap Diameter	Montaj Assembly	
 <p>IL-X...T5 Serisi</p>	129 087 000254 IL-XS-T5-244	Sabit / Continuous	24V	0.9A	24V AC/DC	52 mm	Tabana Montaj Floor-mounted	
	129 087 000255 IL-XS-T5-224		220V	0.9A	220V AC/DC	52 mm	Tabana Montaj Floor-mounted	
	129 087 000257 IL-XF-T5-244	Flaşörlü / Flashing	24V	0.9A	24V AC/DC	52 mm	Tabana Montaj Floor-mounted	
	129 087 000258 IL-XF-T5-224		220V	0.9A	220V AC/DC	52 mm	Tabana Montaj Floor-mounted	
	129 087 000260 IL-XSB-T5-244	Sabit+Buzzer Continuous+Buzzer	24V	0.9A	24V AC/DC	52 mm	Tabana Montaj Floor-mounted	
	129 087 000261 IL-XSB-T5-224		220V	0.9A	220V AC/DC	52 mm	Tabana Montaj Floor-mounted	
	129 087 000263 IL-XFB-T5-244	Flaşörlü+Buzzer Flashing+Buzzer	24V	0.9A	24V AC/DC	52 mm	Tabana Montaj Floor-mounted	
	129 087 000264 IL-XFB-T5-224		220V	0.9A	220V AC/DC	52 mm	Tabana Montaj Floor-mounted	
	Renk Seçenekleri / Color Options: IL-XLS-T5-124 ● ● ● ●							

 <p>IL-X...T5 Serisi</p>	129 087 000266 IL-XS-T5-245	Sabit / Continuous	24V	0.9A	24V AC/DC	52 mm	Tabana Montaj Floor-mounted	
	129 087 000267 IL-XS-T5-225		220V	0.9A	220V AC/DC	52 mm	Tabana Montaj Floor-mounted	
	129 087 000269 IL-XF-T5-245	Flaşörlü / Flashing	24V	0.9A	24V AC/DC	52 mm	Tabana Montaj Floor-mounted	
	129 087 000270 IL-XF-T5-225		220V	0.9A	220V AC/DC	52 mm	Tabana Montaj Floor-mounted	
	129 087 000272 IL-XSB-T5-245	Sabit+Buzzer Continuous+Buzzer	24V	0.9A	24V AC/DC	52 mm	Tabana Montaj Floor-mounted	
	129 087 000273 IL-XSB-T5-225		220V	0.9A	220V AC/DC	52 mm	Tabana Montaj Floor-mounted	
	129 087 000275 IL-XFB-T5-245	Flaşörlü+Buzzer Flashing+Buzzer	24V	0.9A	24V AC/DC	52 mm	Tabana Montaj Floor-mounted	
	129 087 000276 IL-XFB-T5-225		220V	0.9A	220V AC/DC	52 mm	Tabana Montaj Floor-mounted	
	Renk Seçenekleri / Color Options: IL-XS-T5-125 ● ● ● ●							

KORNALAR

HORNS

	Kod Code	Çalışma Şekli Signal Type	Voltaj Voltage	Ses Seviyesi Decibel	Çap Diameter	Çalışma Şekli Mode Operation	Montaj Assembly
	129 087 000230 IL-XB-B-24	Korna Horns	24V	95dB/30 cm	67 mm	Kesik Kesik Intermittent	
	129 087 000233 IL-XB-B-22	Korna Horns	220V	95dB/30 cm	67 mm	Kesik Kesik Intermittent	
	129 087 000235 IL-XB-Q-24	Korna Horns	24V	95dB/30 cm	67 mm	Kesik Kesik Intermittent	
	129 087 000233 IL-XB-Q-22	Korna Horns	220V	95dB/30 cm	67 mm	Kesik Kesik Intermittent	
 	129 087 000245 IL-XFM-12A-905AL70	Buzzer Buzzer	12V	90dB/30 cm	52 mm	Çift Ses Dual Sound	Kablolu Wired
	129 087 000246 IL-XFM-12Q-905L70	Buzzer Buzzer	12V	95dB/60 cm	52 mm	Çift Ses Dual Sound	Kablolu Wired
	129 087 000247 IL-XFM-24C-905L70	Buzzer Buzzer	24V	92dB/100 cm	52 mm	Çift Ses Dual Sound	Kablolu Wired
	129 087 000248 IL-XFM-22A-905AL70	Buzzer Buzzer	220V	95dB/30 cm	52 mm	Çift Ses Dual Sound	Kablolu Wired
	129 087 000249 IL-XFM-24C-900L700	Buzzer Buzzer	24V	92dB/100 cm	52 mm	Sürekli Sesli Continuous Voice	Kablolu Wired
	129 087 000250 IL-XFM-22A-905A	Buzzer Buzzer	12V	90dB/300 cm	52 mm	Çift Ses Dual Sound	Kablolu Wired
	129 087 000251 IL-XFM-12A-905A	Buzzer Buzzer	220V	90dB/30 cm	52 mm	Çift Ses Dual Sound	Kablolu Wired
129 087 000252 IL-XFM-12Q-905	Buzzer Buzzer	12V	90dB/30 cm	52 mm	Çift Ses Dual Sound	Kablolu Wired	

TERMOPLASTİK BUATLAR

THERMOPLASTIC JUNCTION BOXES

	Kod Code	Açıklama Description	Ambalaj Packing	Adet Quantity	Ağırlık Weight	Hacim Volume
	Alev Yaymayan Non Flammable  	Ø 90 Termoplastik Buat Ø 90 Thermoplastic Junction Box	Kutu Pack	108	7,647 kg	0,06858
	001 046 090090 00 17					
	Alev Yayan Flammable	IP40				
	001 046 070090 00 17					
	Alev Yaymayan Non Flammable  	85x85x48 Termoplastik Buat 85x85x48 Thermoplastic Junction Box	Kutu Pack	108	9,288 kg	0,06480
	001 046 098585 00 17					
	Alev Yayan Flammable	IP40				
	001 046 078585 00 17					
	Alev Yaymayan Non Flammable  	80x80x48 Termoplastik 7 Çıkışlı Buat 80x80x48 Thermoplastic Junction Box with 7 outlets	Kutu Pack	108	9,025 kg	0,06858
	001 046 098080 00 17					
	Alev Yayan Flammable	IP40				
	001 046 078080 00 17					
	Alev Yaymayan Non Flammable  	110x110x74 Termoplastik 8 Çıkışlı Buat 110x110x74 Thermoplastic Junction Box with 8 outlets	Kutu Pack	40	9,708 kg	0,04840
	001 046 091010 00 17					
	Alev Yayan Flammable	IP65				
	001 046 071010 00 17					
	Alev Yaymayan Non Flammable  	110x180x77 Termoplastik 10 Çıkışlı Buat 110x180x77 Thermoplastic Junction Box with 10 outlets	Kutu Pack	30	10,908 kg	0,05850
	001 046 091118 00 17					
	Alev Yayan Flammable	IP65				
	001 046 071118 00 17					
	Alev Yaymayan Non Flammable  	180x270x100 Termoplastik 14 Çıkışlı Buat 180x270x100 Thermoplastic Junction Box with 14 outlets	Kutu Pack	8	6,907 kg	0,04728
	001 046 091827 00 17					
	Alev Yayan Flammable	IP65				
	001 046 071827 00 17					

TERMOPLASTİK BUATLAR

THERMOPLASTIC JUNCTION BOXES

	Kod Code	Açıklama Description	Ambalaj Packing	Adet Quantity	Ağırlık Weight	Hacim Volume
	Alev Yaymayan Non Flammable   CE 001 046 092698 00 44	138x226x98 Şeffaf Termoplastik Buat 138x226x98 Transparent Thermoplastic Boxes	Kutu Pack	8	4,110 kg	0,03671
	Alev Yayan Flammable 001 046 072698 00 44	IP65				
	Alev Yaymayan Non Flammable   CE 001 046 096131 00 44	138x226x131 Şeffaf Termoplastik Buat 138x226x131 Transparent Thermoplastic Boxes	Kutu Pack	8	4,565 kg	0,04010
	Alev Yayan Flammable 001 046 076131 00 44	IP65				
	Alev Yaymayan Non Flammable   CE 001 046 091199 00 44	225x311x99 Şeffaf Termoplastik Buat 225x311x99 Transparent Thermoplastic Boxes	Kutu Pack	4	3,500 kg	0,03238
	Alev Yayan Flammable 001 046 071199 00 44	IP65				
	Alev Yaymayan Non Flammable   CE 001 046 091130 00 44	225x311x130 Şeffaf Termoplastik Buat 225x311x130 Transparent Thermoplastic Boxes	Kutu Pack	4	4,100 kg	0,04010
	Alev Yayan Flammable 001 046 071130 00 44	IP65				
	Alev Yaymayan Non Flammable   CE 001 046 092698 00 17	138x226x98 Termoplastik Buat 138x226x98 Thermoplastic Boxes	Kutu Pack	8	3,945 kg	0,02668
	Alev Yayan Flammable 001 046 072698 00 17	IP65				
	Alev Yaymayan Non Flammable   CE 001 046 096131 00 17	138x226x131 Termoplastik Buat 138x226x131 Thermoplastic Boxes	Kutu Pack	8	4,400 kg	0,03694
	Alev Yayan Flammable 001 046 076131 00 17	IP65				
	Alev Yaymayan Non Flammable   CE 001 046 091199 00 17	225x311x99 Termoplastik Buat 225x311x99 Thermoplastic Boxes	Kutu Pack	4	3,375 kg	0,03238
	Alev Yayan Flammable 001 046 071199 00 17	IP65				
	Alev Yaymayan Non Flammable   CE 001 046 091130 00 17	225x311x130 Termoplastik Buat 225x311x130 Thermoplastic Boxes	Kutu Pack	4	3,895 kg	0,03974
	Alev Yayan Flammable 001 046 071130 00 17	IP65				
	Alev Yaymayan Non Flammable  CE 001 046 098226 00 17	138x226x127 Kombinasyon Kutusu 138x226x127 Combination Box	Kutu Pack	8	5,025 kg	0,03694
	Alev Yayan Flammable 001 046 078226 00 17	IP65				
	Alev Yaymayan Non Flammable  CE 001 046 095311 00 17	225x311x132 Kombinasyon Kutusu 225x311x132 Combination Box	Kutu Pack	4	4,210 kg	0,04010
	Alev Yayan Flammable 001 046 075311 00 17	IP65				

PLASTİK OPAK KAPAKLI PANOLAR

PLASTIC PANELS WITH OPAQUE LID

	Kod Code	Açıklama Description	Ambalaj Packing	Adet Quantity	Ağırlık Weight	Hacim Volume
	048 090 203013	20X30X13	Kutu / Pack	1	1,350 kg	0,00800
	048 090 253515	25X35X15	Kutu / Pack	1	2,125 kg	0,01300
	048 090 304017	30X40X17	Kutu / Pack	1	2,845 kg	0,02000
	048 090 304022	30X40X22	Kutu / Pack	1	3,125 kg	0,02600
	048 090 355019	35X50X19	Kutu / Pack	1	3,900 kg	0,03300
	048 090 405018	40X50X18	Kutu / Pack	1	4,300 kg	0,03600
	048 090 405024	40X50X24	Kutu / Pack	1	5,000 kg	0,04800
	048 090 406020	40X60X20	Kutu / Pack	1	5,000 kg	0,04800
	048 090 507025	50X70X25	Kutu / Pack	1	8,500 kg	0,08800
	048 090 608026	60x80x26	Kutu / Pack	1	13,000 kg	0,12500

PLASTİK ŞEFFAF KAPAKLI PANOLAR















PLASTIC PANELS WITH TRANSPARENT LID

	Kod Code	Açıklama Description	Ambalaj Packing	Adet Quantity	Ağırlık Weight	Hacim Volume
	048 088 203013	20X30X13	Kutu / Pack	1	1,390 kg	0,00800
	048 088 253515	25X35X15	Kutu / Pack	1	2,190 kg	0,01300
	048 088 304017	30X40X17	Kutu / Pack	1	2,950 kg	0,02000
	048 088 304022	30X40X22	Kutu / Pack	1	3,250 kg	0,02600
	048 088 355019	35X50X19	Kutu / Pack	1	4,000 kg	0,03300
	048 088 405018	40X50X18	Kutu / Pack	1	4,450 kg	0,03600
	048 088 405024	40X50X24	Kutu / Pack	1	5,130 kg	0,04800
	048 088 406020	40X60X20	Kutu / Pack	1	5,200 kg	0,04800
	048 088 507025	50X70X25	Kutu / Pack	1	8,650 kg	0,08800
	048 088 608026	60x80x26	Kutu / Pack	1	13,420 kg	0,12500

KARE BUATLAR

SQUARE JUNCTION BOXES

IP40

	001 046 051010 00 12	   Alev Yayımayan 10x10 Kare Buat Turuncu Non Flammable 10x10 Square Junc Orange	Kutu Pack	10	0,833 kg	0,00610
	001 046 021010 00 12	 Alev Yayan 10x10 Kare Buat Turuncu Flammable 10x10 Square Junc Orange	Kutu Pack	10	0,833 kg	0,00610
	001 046 051212 00 12	   Alev Yayımayan 12x12 Kare Buat Turuncu Non Flammable 12x12 Square Junc Orange	Kutu Pack	10	1,020 kg	0,00928
	001 046 021212 00 12	 Alev Yayan 12x12 Kare Buat Turuncu Flammable 12x12 Square Junc Orange	Kutu Pack	10	1,020 kg	0,00928
	001 046 051515 00 12	   Alev Yayımayan 15x15 Kare Buat Turuncu Non Flammable 15x15 Square Junc Orange	Kutu Pack	10	1,850 kg	0,01509
	001 046 021515 00 12	 Alev Yayan 15x15 Kare Buat Turuncu Flammable 15x15 Square Junc Orange	Kutu Pack	10	1,850 kg	0,01509
	001 046 052020 00 12	   Alev Yayımayan 20x20 Kare Buat Turuncu Non Flammable 20x20 Square Junc Orange	Kutu Pack	10	2,829 kg	0,02772
	001 046 022020 00 12	 Alev Yayan 20x20 Kare Buat Turuncu Flammable 20x20 Square Junc Orange	Kutu Pack	10	2,857 kg	0,02772



TESİSAT MALZEMELERİ
INSTALLATION
MATERIALS

COMFORT W Otomat kutusu Fuse Box



- Estetik, sade, gözleri yormayan düz ve keskin hatlara sahip olan modern görsel tasarım
- 4 Vida ile sağlam kapak tesbiti
- Kolay ve pratik, arıza ihtimali olmayan açma-kapama özelliğine sahip cam
- Ip 40 koruma özelliği
- Sıva altı serisinde kolay ve tabana sıfır kırılan,
- Üstte-altta-yanda ve arkada yer alan çok sayıda kablo giriş pencereleri
- Çift taraflı (sağa ve sola) açılabilen cam
- Her iki yönde de kullanılabilen sıva altı ve sıva üstü gövdeler
- Sıva üstü gövdede arkada, altta ve üstte gizli-kolay kırılabilir kablo giriş pencereleri
- Sıva üstü serisinde pg 13-pg 16 rakor ve 21-25 mm çapta boru girişine müsait kablo giriş pencereleri
- Sıva altı serisinde max 32 mm çapta boru girişine sahip kablo giriş pencereleri
- Kablo bağlantıları için geniş iç hacim
- Mukavemetli alt ve yan duvarlar
- Sıva altı ve sıva üstü serisinde ortak kullanılabilen kapak ve cam

- Modern visual design with aesthetic, simple, flat and sharp lines
- Cover fixing with 4 screws
- Easy and practical, open-close glass with no possibility of malfunction
- Ip 40 protection feature
- Easy and zero based in flush mounted series
- Many cable entry windows on the top-bottom-side and rear
- Double-sided (right and left) opened glass
- Flush and surface-mounted bodies that can be used in both side
- Easy-to-break cable entry windows at the rear, top and bottom on surface mounted body
- Cable entry windows suitable for pipe entry of 16 gauge pg 13-pg diameter and 21-25 mm diameter in the surface mounted series
- Cable entry windows with pipe entrance of maximum 32 mm diameter in flush mounted series
- Wider internal volume for cable connections
- Strengthened bottom and side walls
- Cover and glass that can be used in flush and surface mounted series



BOYUTLAR • DIMENSIONS

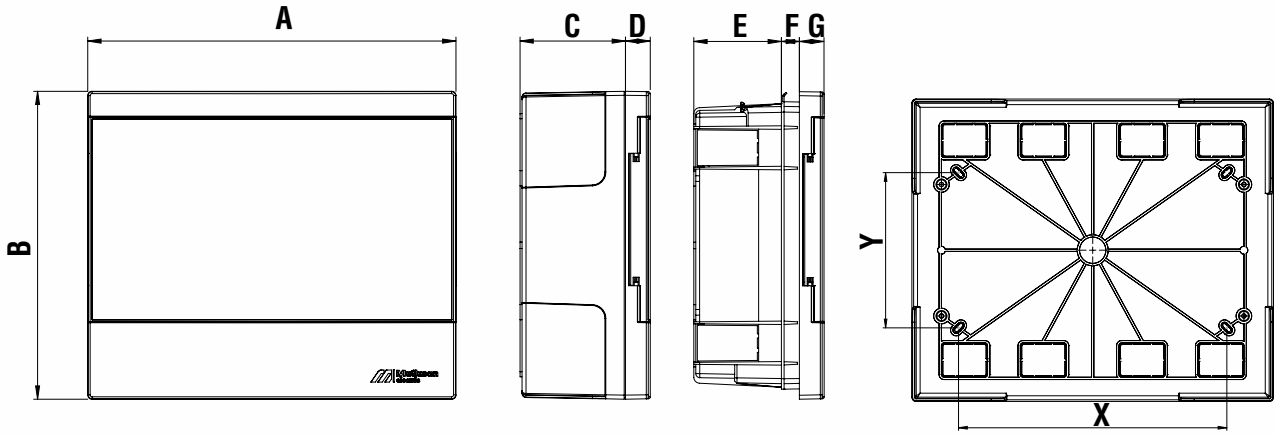

ÖLÇÜLER / SIZES	SIVA ALTI FLUSH		A	B	C	D	E	F	G	X	Y
		6	167	180				65,5	13,5	18,5	
9	221	180				65,5	13,5	18,5			
12	275	230				65,5	13,5	18,5			
18	383	230				65,5	13,5	18,5			
24	275	345				65,5	13,5	18,5			
36	275	460				65,5	13,5	18,5			
SIVA ÜSTÜ SURFACE	6	167	180	78,8	18,5					70	80
	9	221	180	78,8	18,5					133	80
12	275	230	78,8	18,5					204	118	
18	383	230	78,8	18,5					312	118	
24	275	345	78,8	18,5					204	233	
36	275	460	78,8	18,5					204	348	

Terminal koruma seviyesi(Koruma Sınıfı) : IP 40
 Kutuların tipi : Dikdörtgen kutulardır
 Tesis sırasındaki sıcaklık aralığı : -25°C / +60°C
 Yalıtım direnci : 5 MΩ' un üzerindedir
 Yüksek gerilime dayanım : 3750 V AC(alternatif akım,
 220 V /400 V ~50 Hz)

Terminal protection level (Protection class) : IP 40
 Types of boxes : Rectangular boxes
 The temperature range during installation : -25°C / +60°C
 Insulation resistance : over 5 MΩ
 High tensile resistance : 3750 V AC
 (alternative current, 220 V /400 V ~50 Hz)











COMFORT W OTOMAT KUTULARI H.FREE (ALEV YAYAN)
COMFORT FUSE BOXES H.FREE (NON FLAMMABLE)

IP40

 <p>001 057 120006 00 00 Alev Yayan Flammable </p> <p>6 'lı Sıva Üstü W Otomat Kutusu Surface-Mounted Fuse Box , 6 Fuse</p> <table border="1"> <tr> <td>Ambalaj Şekli / Package Type</td> <td>Kutu / Pack</td> </tr> <tr> <td>Adet / m / Quantity / m</td> <td>20</td> </tr> <tr> <td>Ağırlık / Weight</td> <td>10,78 kg</td> </tr> <tr> <td>m³ / Volume</td> <td>0,06766</td> </tr> </table>	Ambalaj Şekli / Package Type	Kutu / Pack	Adet / m / Quantity / m	20	Ağırlık / Weight	10,78 kg	m ³ / Volume	0,06766	 <p>001 057 020006 00 00 Alev Yayan Flammable </p> <p>6 'lı Sıva Altı W Otomat Kutusu Flush-Mounted Fuse Box , 6 Fuse</p> <table border="1"> <tr> <td>Ambalaj Şekli / Package Type</td> <td>Kutu / Pack</td> </tr> <tr> <td>Adet / m / Quantity / m</td> <td>20</td> </tr> <tr> <td>Ağırlık / Weight</td> <td>10,20 kg</td> </tr> <tr> <td>m³ / Volume</td> <td>0,06766</td> </tr> </table>	Ambalaj Şekli / Package Type	Kutu / Pack	Adet / m / Quantity / m	20	Ağırlık / Weight	10,20 kg	m ³ / Volume	0,06766
Ambalaj Şekli / Package Type	Kutu / Pack																
Adet / m / Quantity / m	20																
Ağırlık / Weight	10,78 kg																
m ³ / Volume	0,06766																
Ambalaj Şekli / Package Type	Kutu / Pack																
Adet / m / Quantity / m	20																
Ağırlık / Weight	10,20 kg																
m ³ / Volume	0,06766																
 <p>001 057 120009 00 00 Alev Yayan Flammable </p> <p>9 'lu Sıva Üstü W Otomat Kutusu Surface-Mounted Fuse Box , 9 Fuse</p> <table border="1"> <tr> <td>Ambalaj Şekli / Package Type</td> <td>Kutu / Pack</td> </tr> <tr> <td>Adet / m / Quantity / m</td> <td>20</td> </tr> <tr> <td>Ağırlık / Weight</td> <td>13,00 kg</td> </tr> <tr> <td>m³ / Volume</td> <td>0,09150</td> </tr> </table>	Ambalaj Şekli / Package Type	Kutu / Pack	Adet / m / Quantity / m	20	Ağırlık / Weight	13,00 kg	m ³ / Volume	0,09150	 <p>001 057 020009 00 00 Alev Yayan Flammable </p> <p>9 'lu Sıva Altı W Otomat Kutusu Flush-Mounted Fuse Box , 9 Fuse</p> <table border="1"> <tr> <td>Ambalaj Şekli / Package Type</td> <td>Kutu / Pack</td> </tr> <tr> <td>Adet / m / Quantity / m</td> <td>20</td> </tr> <tr> <td>Ağırlık / Weight</td> <td>12,66 kg</td> </tr> <tr> <td>m³ / Volume</td> <td>0,09150</td> </tr> </table>	Ambalaj Şekli / Package Type	Kutu / Pack	Adet / m / Quantity / m	20	Ağırlık / Weight	12,66 kg	m ³ / Volume	0,09150
Ambalaj Şekli / Package Type	Kutu / Pack																
Adet / m / Quantity / m	20																
Ağırlık / Weight	13,00 kg																
m ³ / Volume	0,09150																
Ambalaj Şekli / Package Type	Kutu / Pack																
Adet / m / Quantity / m	20																
Ağırlık / Weight	12,66 kg																
m ³ / Volume	0,09150																
 <p>001 057 120012 00 00 Alev Yayan Flammable </p> <p>12 'li Sıva Üstü W Otomat Kutusu Surface-Mounted Fuse Box , 12 Fuse</p> <table border="1"> <tr> <td>Ambalaj Şekli / Package Type</td> <td>Kutu / Pack</td> </tr> <tr> <td>Adet / m / Quantity / m</td> <td>10</td> </tr> <tr> <td>Ağırlık / Weight</td> <td>9,00 kg</td> </tr> <tr> <td>m³ / Volume</td> <td>0,07207</td> </tr> </table>	Ambalaj Şekli / Package Type	Kutu / Pack	Adet / m / Quantity / m	10	Ağırlık / Weight	9,00 kg	m ³ / Volume	0,07207	 <p>001 057 020012 00 00 Alev Yayan Flammable </p> <p>12 'li Sıva Altı W Otomat Kutusu Flush-Mounted Fuse Box , 12 Fuse</p> <table border="1"> <tr> <td>Ambalaj Şekli / Package Type</td> <td>Kutu / Pack</td> </tr> <tr> <td>Adet / m / Quantity / m</td> <td>10</td> </tr> <tr> <td>Ağırlık / Weight</td> <td>8,50 kg</td> </tr> <tr> <td>m³ / Volume</td> <td>0,07207</td> </tr> </table>	Ambalaj Şekli / Package Type	Kutu / Pack	Adet / m / Quantity / m	10	Ağırlık / Weight	8,50 kg	m ³ / Volume	0,07207
Ambalaj Şekli / Package Type	Kutu / Pack																
Adet / m / Quantity / m	10																
Ağırlık / Weight	9,00 kg																
m ³ / Volume	0,07207																
Ambalaj Şekli / Package Type	Kutu / Pack																
Adet / m / Quantity / m	10																
Ağırlık / Weight	8,50 kg																
m ³ / Volume	0,07207																
 <p>001 057 120018 00 00 Alev Yayan Flammable </p> <p>18 'li Sıva Üstü W Otomat Kutusu Surface-Mounted Fuse Box , 18 Fuse</p> <table border="1"> <tr> <td>Ambalaj Şekli / Package Type</td> <td>Kutu / Pack</td> </tr> <tr> <td>Adet / m / Quantity / m</td> <td>10</td> </tr> <tr> <td>Ağırlık / Weight</td> <td>12,70 kg</td> </tr> <tr> <td>m³ / Volume</td> <td>0,10181</td> </tr> </table>	Ambalaj Şekli / Package Type	Kutu / Pack	Adet / m / Quantity / m	10	Ağırlık / Weight	12,70 kg	m ³ / Volume	0,10181	 <p>001 057 020018 00 00 Alev Yayan Flammable </p> <p>18 'li Sıva Altı W Otomat Kutusu Flush-Mounted Fuse Box , 18 Fuse</p> <table border="1"> <tr> <td>Ambalaj Şekli / Package Type</td> <td>Kutu / Pack</td> </tr> <tr> <td>Adet / m / Quantity / m</td> <td>10</td> </tr> <tr> <td>Ağırlık / Weight</td> <td>11,63 kg</td> </tr> <tr> <td>m³ / Volume</td> <td>0,10181</td> </tr> </table>	Ambalaj Şekli / Package Type	Kutu / Pack	Adet / m / Quantity / m	10	Ağırlık / Weight	11,63 kg	m ³ / Volume	0,10181
Ambalaj Şekli / Package Type	Kutu / Pack																
Adet / m / Quantity / m	10																
Ağırlık / Weight	12,70 kg																
m ³ / Volume	0,10181																
Ambalaj Şekli / Package Type	Kutu / Pack																
Adet / m / Quantity / m	10																
Ağırlık / Weight	11,63 kg																
m ³ / Volume	0,10181																
 <p>001 057 120024 00 00 Alev Yayan Flammable </p> <p>24 'lü Sıva Üstü W Otomat Kutusu Surface-Mounted Fuse Box , 24 Fuse</p> <table border="1"> <tr> <td>Ambalaj Şekli / Package Type</td> <td>Kutu / Pack</td> </tr> <tr> <td>Adet / m / Quantity / m</td> <td>5</td> </tr> <tr> <td>Ağırlık / Weight</td> <td>7,10 kg</td> </tr> <tr> <td>m³ / Volume</td> <td>0,05507</td> </tr> </table>	Ambalaj Şekli / Package Type	Kutu / Pack	Adet / m / Quantity / m	5	Ağırlık / Weight	7,10 kg	m ³ / Volume	0,05507	 <p>001 057 020024 00 00 Alev Yayan Flammable </p> <p>24 'lü Sıva Altı W Otomat Kutusu Flush-Mounted Fuse Box , 24 Fuse</p> <table border="1"> <tr> <td>Ambalaj Şekli / Package Type</td> <td>Kutu / Pack</td> </tr> <tr> <td>Adet / m / Quantity / m</td> <td>5</td> </tr> <tr> <td>Ağırlık / Weight</td> <td>6,79 kg</td> </tr> <tr> <td>m³ / Volume</td> <td>0,05507</td> </tr> </table>	Ambalaj Şekli / Package Type	Kutu / Pack	Adet / m / Quantity / m	5	Ağırlık / Weight	6,79 kg	m ³ / Volume	0,05507
Ambalaj Şekli / Package Type	Kutu / Pack																
Adet / m / Quantity / m	5																
Ağırlık / Weight	7,10 kg																
m ³ / Volume	0,05507																
Ambalaj Şekli / Package Type	Kutu / Pack																
Adet / m / Quantity / m	5																
Ağırlık / Weight	6,79 kg																
m ³ / Volume	0,05507																
 <p>001 057 120036 00 00 Alev Yayan Flammable </p> <p>36 'lı Sıva Üstü W Otomat Kutusu Surface-Mounted Fuse Box , 36 Fuse</p> <table border="1"> <tr> <td>Ambalaj Şekli / Package Type</td> <td>Kutu / Pack</td> </tr> <tr> <td>Adet / m / Quantity / m</td> <td>5</td> </tr> <tr> <td>Ağırlık / Weight</td> <td>9,25 kg</td> </tr> <tr> <td>m³ / Volume</td> <td>0,07306</td> </tr> </table>	Ambalaj Şekli / Package Type	Kutu / Pack	Adet / m / Quantity / m	5	Ağırlık / Weight	9,25 kg	m ³ / Volume	0,07306	 <p>001 057 020036 00 00 Alev Yayan Flammable </p> <p>36 'lı Sıva Altı W Otomat Kutusu Flush-Mounted Fuse Box , 36 Fuse</p> <table border="1"> <tr> <td>Ambalaj Şekli / Package Type</td> <td>Kutu / Pack</td> </tr> <tr> <td>Adet / m / Quantity / m</td> <td>5</td> </tr> <tr> <td>Ağırlık / Weight</td> <td>8,825 kg</td> </tr> <tr> <td>m³ / Volume</td> <td>0,07306</td> </tr> </table>	Ambalaj Şekli / Package Type	Kutu / Pack	Adet / m / Quantity / m	5	Ağırlık / Weight	8,825 kg	m ³ / Volume	0,07306
Ambalaj Şekli / Package Type	Kutu / Pack																
Adet / m / Quantity / m	5																
Ağırlık / Weight	9,25 kg																
m ³ / Volume	0,07306																
Ambalaj Şekli / Package Type	Kutu / Pack																
Adet / m / Quantity / m	5																
Ağırlık / Weight	8,825 kg																
m ³ / Volume	0,07306																



COMFORT W OTOMAT KUTULARI (ALEV YAYMAYAN) COMFORT FUSE BOXES (NON FLAMMABLE)

IP40

 <p>001 057 110006 00 00 Alev Yaymayan Non Flammable</p> <p>6 'lı Sıva Üstü W Otomat Kutusu Surface-Mounted Fuse Box , 6 Fuse</p> <table border="1"> <tr> <td>Ambalaj Şekli / Package Type</td> <td>Kutu / Pack</td> </tr> <tr> <td>Adet / m / Quantity / m</td> <td>20</td> </tr> <tr> <td>Ağırlık / Weight</td> <td>11,68 kg</td> </tr> <tr> <td>m³ / Volume</td> <td>0,06766</td> </tr> </table>	Ambalaj Şekli / Package Type	Kutu / Pack	Adet / m / Quantity / m	20	Ağırlık / Weight	11,68 kg	m ³ / Volume	0,06766	 <p>001 057 010006 00 00 Alev Yaymayan Non Flammable</p> <p>6 'lı Sıva Alın W Otomat Kutusu Flush-Mounted Fuse Box , 6 Fuse</p> <table border="1"> <tr> <td>Ambalaj Şekli / Package Type</td> <td>Kutu / Pack</td> </tr> <tr> <td>Adet / m / Quantity / m</td> <td>20</td> </tr> <tr> <td>Ağırlık / Weight</td> <td>10,90 kg</td> </tr> <tr> <td>m³ / Volume</td> <td>0,06766</td> </tr> </table>	Ambalaj Şekli / Package Type	Kutu / Pack	Adet / m / Quantity / m	20	Ağırlık / Weight	10,90 kg	m ³ / Volume	0,06766
Ambalaj Şekli / Package Type	Kutu / Pack																
Adet / m / Quantity / m	20																
Ağırlık / Weight	11,68 kg																
m ³ / Volume	0,06766																
Ambalaj Şekli / Package Type	Kutu / Pack																
Adet / m / Quantity / m	20																
Ağırlık / Weight	10,90 kg																
m ³ / Volume	0,06766																
 <p>001 057 110009 00 00 Alev Yaymayan Non Flammable</p> <p>9 'lu Sıva Üstü W Otomat Kutusu Surface-Mounted Fuse Box , 9 Fuse</p> <table border="1"> <tr> <td>Ambalaj Şekli / Package Type</td> <td>Kutu / Pack</td> </tr> <tr> <td>Adet / m / Quantity / m</td> <td>20</td> </tr> <tr> <td>Ağırlık / Weight</td> <td>13,90 kg</td> </tr> <tr> <td>m³ / Volume</td> <td>0,09150</td> </tr> </table>	Ambalaj Şekli / Package Type	Kutu / Pack	Adet / m / Quantity / m	20	Ağırlık / Weight	13,90 kg	m ³ / Volume	0,09150	 <p>001 057 010009 00 00 Alev Yaymayan Non Flammable</p> <p>9 'lu Sıva Alın W Otomat Kutusu Flush-Mounted Fuse Box , 9 Fuse</p> <table border="1"> <tr> <td>Ambalaj Şekli / Package Type</td> <td>Kutu / Pack</td> </tr> <tr> <td>Adet / m / Quantity / m</td> <td>20</td> </tr> <tr> <td>Ağırlık / Weight</td> <td>12,36 kg</td> </tr> <tr> <td>m³ / Volume</td> <td>0,09150</td> </tr> </table>	Ambalaj Şekli / Package Type	Kutu / Pack	Adet / m / Quantity / m	20	Ağırlık / Weight	12,36 kg	m ³ / Volume	0,09150
Ambalaj Şekli / Package Type	Kutu / Pack																
Adet / m / Quantity / m	20																
Ağırlık / Weight	13,90 kg																
m ³ / Volume	0,09150																
Ambalaj Şekli / Package Type	Kutu / Pack																
Adet / m / Quantity / m	20																
Ağırlık / Weight	12,36 kg																
m ³ / Volume	0,09150																
 <p>001 057 110012 00 00 Alev Yaymayan Non Flammable</p> <p>12 'li Sıva Üstü W Otomat Kutusu Surface-Mounted Fuse Box , 12 Fuse</p> <table border="1"> <tr> <td>Ambalaj Şekli / Package Type</td> <td>Kutu / Pack</td> </tr> <tr> <td>Adet / m / Quantity / m</td> <td>10</td> </tr> <tr> <td>Ağırlık / Weight</td> <td>9,54 kg</td> </tr> <tr> <td>m³ / Volume</td> <td>0,07207</td> </tr> </table>	Ambalaj Şekli / Package Type	Kutu / Pack	Adet / m / Quantity / m	10	Ağırlık / Weight	9,54 kg	m ³ / Volume	0,07207	 <p>001 057 010012 00 00 Alev Yaymayan Non Flammable</p> <p>12 'li Sıva Alın W Otomat Kutusu Flush-Mounted Fuse Box , 12 Fuse</p> <table border="1"> <tr> <td>Ambalaj Şekli / Package Type</td> <td>Kutu / Pack</td> </tr> <tr> <td>Adet / m / Quantity / m</td> <td>10</td> </tr> <tr> <td>Ağırlık / Weight</td> <td>6,80 kg</td> </tr> <tr> <td>m³ / Volume</td> <td>0,07207</td> </tr> </table>	Ambalaj Şekli / Package Type	Kutu / Pack	Adet / m / Quantity / m	10	Ağırlık / Weight	6,80 kg	m ³ / Volume	0,07207
Ambalaj Şekli / Package Type	Kutu / Pack																
Adet / m / Quantity / m	10																
Ağırlık / Weight	9,54 kg																
m ³ / Volume	0,07207																
Ambalaj Şekli / Package Type	Kutu / Pack																
Adet / m / Quantity / m	10																
Ağırlık / Weight	6,80 kg																
m ³ / Volume	0,07207																
 <p>001 057 110018 00 00 Alev Yaymayan Non Flammable</p> <p>18 'li Sıva Üstü W Otomat Kutusu Surface-Mounted Fuse Box , 18 Fuse</p> <table border="1"> <tr> <td>Ambalaj Şekli / Package Type</td> <td>Kutu / Pack</td> </tr> <tr> <td>Adet / m / Quantity / m</td> <td>10</td> </tr> <tr> <td>Ağırlık / Weight</td> <td>13,83 kg</td> </tr> <tr> <td>m³ / Volume</td> <td>0,10181</td> </tr> </table>	Ambalaj Şekli / Package Type	Kutu / Pack	Adet / m / Quantity / m	10	Ağırlık / Weight	13,83 kg	m ³ / Volume	0,10181	 <p>001 057 010018 00 00 Alev Yaymayan Non Flammable</p> <p>18 'li Sıva Alın W Otomat Kutusu Flush-Mounted Fuse Box , 18 Fuse</p> <table border="1"> <tr> <td>Ambalaj Şekli / Package Type</td> <td>Kutu / Pack</td> </tr> <tr> <td>Adet / m / Quantity / m</td> <td>10</td> </tr> <tr> <td>Ağırlık / Weight</td> <td>12,27 kg</td> </tr> <tr> <td>m³ / Volume</td> <td>0,10181</td> </tr> </table>	Ambalaj Şekli / Package Type	Kutu / Pack	Adet / m / Quantity / m	10	Ağırlık / Weight	12,27 kg	m ³ / Volume	0,10181
Ambalaj Şekli / Package Type	Kutu / Pack																
Adet / m / Quantity / m	10																
Ağırlık / Weight	13,83 kg																
m ³ / Volume	0,10181																
Ambalaj Şekli / Package Type	Kutu / Pack																
Adet / m / Quantity / m	10																
Ağırlık / Weight	12,27 kg																
m ³ / Volume	0,10181																
 <p>001 057 110024 00 00 Alev Yaymayan Non Flammable</p> <p>24 'lü Sıva Üstü W Otomat Kutusu Surface-Mounted Fuse Box , 24 Fuse</p> <table border="1"> <tr> <td>Ambalaj Şekli / Package Type</td> <td>Kutu / Pack</td> </tr> <tr> <td>Adet / m / Quantity / m</td> <td>5</td> </tr> <tr> <td>Ağırlık / Weight</td> <td>6,175 kg</td> </tr> <tr> <td>m³ / Volume</td> <td>0,05507</td> </tr> </table>	Ambalaj Şekli / Package Type	Kutu / Pack	Adet / m / Quantity / m	5	Ağırlık / Weight	6,175 kg	m ³ / Volume	0,05507	 <p>001 057 010024 00 00 Alev Yaymayan Non Flammable</p> <p>24 'lü Sıva Alın W Otomat Kutusu Flush-Mounted Fuse Box , 24 Fuse</p> <table border="1"> <tr> <td>Ambalaj Şekli / Package Type</td> <td>Kutu / Pack</td> </tr> <tr> <td>Adet / m / Quantity / m</td> <td>5</td> </tr> <tr> <td>Ağırlık / Weight</td> <td>7,22 kg</td> </tr> <tr> <td>m³ / Volume</td> <td>0,05507</td> </tr> </table>	Ambalaj Şekli / Package Type	Kutu / Pack	Adet / m / Quantity / m	5	Ağırlık / Weight	7,22 kg	m ³ / Volume	0,05507
Ambalaj Şekli / Package Type	Kutu / Pack																
Adet / m / Quantity / m	5																
Ağırlık / Weight	6,175 kg																
m ³ / Volume	0,05507																
Ambalaj Şekli / Package Type	Kutu / Pack																
Adet / m / Quantity / m	5																
Ağırlık / Weight	7,22 kg																
m ³ / Volume	0,05507																
 <p>001 057 110036 00 00 Alev Yaymayan Non Flammable</p> <p>36 'lı Sıva Üstü W Otomat Kutusu Surface-Mounted Fuse Box , 36 Fuse</p> <table border="1"> <tr> <td>Ambalaj Şekli / Package Type</td> <td>Kutu / Pack</td> </tr> <tr> <td>Adet / m / Quantity / m</td> <td>5</td> </tr> <tr> <td>Ağırlık / Weight</td> <td>7,775 kg</td> </tr> <tr> <td>m³ / Volume</td> <td>0,07306</td> </tr> </table>	Ambalaj Şekli / Package Type	Kutu / Pack	Adet / m / Quantity / m	5	Ağırlık / Weight	7,775 kg	m ³ / Volume	0,07306	 <p>001 057 010036 00 00 Alev Yaymayan Non Flammable</p> <p>36 'lı Sıva Alın W Otomat Kutusu Flush-Mounted Fuse Box , 36 Fuse</p> <table border="1"> <tr> <td>Ambalaj Şekli / Package Type</td> <td>Kutu / Pack</td> </tr> <tr> <td>Adet / m / Quantity / m</td> <td>5</td> </tr> <tr> <td>Ağırlık / Weight</td> <td>9,58 kg</td> </tr> <tr> <td>m³ / Volume</td> <td>0,07306</td> </tr> </table>	Ambalaj Şekli / Package Type	Kutu / Pack	Adet / m / Quantity / m	5	Ağırlık / Weight	9,58 kg	m ³ / Volume	0,07306
Ambalaj Şekli / Package Type	Kutu / Pack																
Adet / m / Quantity / m	5																
Ağırlık / Weight	7,775 kg																
m ³ / Volume	0,07306																
Ambalaj Şekli / Package Type	Kutu / Pack																
Adet / m / Quantity / m	5																
Ağırlık / Weight	9,58 kg																
m ³ / Volume	0,07306																

COMFORT W OTOMAT KUTULARI COMFORT FUSE BOXES

IP40

 <p>001 057 100006 00 00 Alev Yaymayan Non Flammable</p> <p>6 'lı Sıva Üstü W Otomat Kutusu Surface-Mounted Fuse Box , 6 Fuse</p> <table border="1"> <tr> <td>Ambalaj Şekli / Package Type</td> <td>Kutu / Pack</td> </tr> <tr> <td>Adet / m / Quantity / m</td> <td>20</td> </tr> <tr> <td>Ağırlık / Weight</td> <td>10,46 kg</td> </tr> <tr> <td>m³ / Volume</td> <td>0,06766</td> </tr> </table>	Ambalaj Şekli / Package Type	Kutu / Pack	Adet / m / Quantity / m	20	Ağırlık / Weight	10,46 kg	m ³ / Volume	0,06766	 <p>001 057 000006 00 00 Alev Yaymayan Non Flammable</p> <p>6 'lı Sıva Alın W Otomat Kutusu Flush-Mounted Fuse Box , 6 Fuse</p> <table border="1"> <tr> <td>Ambalaj Şekli / Package Type</td> <td>Kutu / Pack</td> </tr> <tr> <td>Adet / m / Quantity / m</td> <td>20</td> </tr> <tr> <td>Ağırlık / Weight</td> <td>9,88 kg</td> </tr> <tr> <td>m³ / Volume</td> <td>0,06766</td> </tr> </table>	Ambalaj Şekli / Package Type	Kutu / Pack	Adet / m / Quantity / m	20	Ağırlık / Weight	9,88 kg	m ³ / Volume	0,06766
Ambalaj Şekli / Package Type	Kutu / Pack																
Adet / m / Quantity / m	20																
Ağırlık / Weight	10,46 kg																
m ³ / Volume	0,06766																
Ambalaj Şekli / Package Type	Kutu / Pack																
Adet / m / Quantity / m	20																
Ağırlık / Weight	9,88 kg																
m ³ / Volume	0,06766																
 <p>001 057 100009 00 00 Alev Yaymayan Non Flammable</p> <p>9 'lu Sıva Üstü W Otomat Kutusu Surface-Mounted Fuse Box , 9 Fuse</p> <table border="1"> <tr> <td>Ambalaj Şekli / Package Type</td> <td>Kutu / Pack</td> </tr> <tr> <td>Adet / m / Quantity / m</td> <td>20</td> </tr> <tr> <td>Ağırlık / Weight</td> <td>12,94 kg</td> </tr> <tr> <td>m³ / Volume</td> <td>0,09150</td> </tr> </table>	Ambalaj Şekli / Package Type	Kutu / Pack	Adet / m / Quantity / m	20	Ağırlık / Weight	12,94 kg	m ³ / Volume	0,09150	 <p>001 057 000009 00 00 Alev Yaymayan Non Flammable</p> <p>9 'lu Sıva Alın W Otomat Kutusu Flush-Mounted Fuse Box , 9 Fuse</p> <table border="1"> <tr> <td>Ambalaj Şekli / Package Type</td> <td>Kutu / Pack</td> </tr> <tr> <td>Adet / m / Quantity / m</td> <td>20</td> </tr> <tr> <td>Ağırlık / Weight</td> <td>12,352 kg</td> </tr> <tr> <td>m³ / Volume</td> <td>0,09150</td> </tr> </table>	Ambalaj Şekli / Package Type	Kutu / Pack	Adet / m / Quantity / m	20	Ağırlık / Weight	12,352 kg	m ³ / Volume	0,09150
Ambalaj Şekli / Package Type	Kutu / Pack																
Adet / m / Quantity / m	20																
Ağırlık / Weight	12,94 kg																
m ³ / Volume	0,09150																
Ambalaj Şekli / Package Type	Kutu / Pack																
Adet / m / Quantity / m	20																
Ağırlık / Weight	12,352 kg																
m ³ / Volume	0,09150																
 <p>001 057 100012 00 00 Alev Yaymayan Non Flammable</p> <p>12 'li Sıva Üstü W Otomat Kutusu Surface-Mounted Fuse Box , 12 Fuse</p> <table border="1"> <tr> <td>Ambalaj Şekli / Package Type</td> <td>Kutu / Pack</td> </tr> <tr> <td>Adet / m / Quantity / m</td> <td>10</td> </tr> <tr> <td>Ağırlık / Weight</td> <td>8,73 kg</td> </tr> <tr> <td>m³ / Volume</td> <td>0,07207</td> </tr> </table>	Ambalaj Şekli / Package Type	Kutu / Pack	Adet / m / Quantity / m	10	Ağırlık / Weight	8,73 kg	m ³ / Volume	0,07207	 <p>001 057 000012 00 00 Alev Yaymayan Non Flammable</p> <p>12 'li Sıva Alın W Otomat Kutusu Flush-Mounted Fuse Box , 12 Fuse</p> <table border="1"> <tr> <td>Ambalaj Şekli / Package Type</td> <td>Kutu / Pack</td> </tr> <tr> <td>Adet / m / Quantity / m</td> <td>10</td> </tr> <tr> <td>Ağırlık / Weight</td> <td>8,60 kg</td> </tr> <tr> <td>m³ / Volume</td> <td>0,07207</td> </tr> </table>	Ambalaj Şekli / Package Type	Kutu / Pack	Adet / m / Quantity / m	10	Ağırlık / Weight	8,60 kg	m ³ / Volume	0,07207
Ambalaj Şekli / Package Type	Kutu / Pack																
Adet / m / Quantity / m	10																
Ağırlık / Weight	8,73 kg																
m ³ / Volume	0,07207																
Ambalaj Şekli / Package Type	Kutu / Pack																
Adet / m / Quantity / m	10																
Ağırlık / Weight	8,60 kg																
m ³ / Volume	0,07207																
 <p>001 057 100018 00 00 Alev Yaymayan Non Flammable</p> <p>18 'li Sıva Üstü W Otomat Kutusu Surface-Mounted Fuse Box , 18 Fuse</p> <table border="1"> <tr> <td>Ambalaj Şekli / Package Type</td> <td>Kutu / Pack</td> </tr> <tr> <td>Adet / m / Quantity / m</td> <td>10</td> </tr> <tr> <td>Ağırlık / Weight</td> <td>12,604 kg</td> </tr> <tr> <td>m³ / Volume</td> <td>0,10181</td> </tr> </table>	Ambalaj Şekli / Package Type	Kutu / Pack	Adet / m / Quantity / m	10	Ağırlık / Weight	12,604 kg	m ³ / Volume	0,10181	 <p>001 057 000018 00 00 Alev Yaymayan Non Flammable</p> <p>18 'li Sıva Alın W Otomat Kutusu Flush-Mounted Fuse Box , 18 Fuse</p> <table border="1"> <tr> <td>Ambalaj Şekli / Package Type</td> <td>Kutu / Pack</td> </tr> <tr> <td>Adet / m / Quantity / m</td> <td>10</td> </tr> <tr> <td>Ağırlık / Weight</td> <td>11,738 kg</td> </tr> <tr> <td>m³ / Volume</td> <td>0,10181</td> </tr> </table>	Ambalaj Şekli / Package Type	Kutu / Pack	Adet / m / Quantity / m	10	Ağırlık / Weight	11,738 kg	m ³ / Volume	0,10181
Ambalaj Şekli / Package Type	Kutu / Pack																
Adet / m / Quantity / m	10																
Ağırlık / Weight	12,604 kg																
m ³ / Volume	0,10181																
Ambalaj Şekli / Package Type	Kutu / Pack																
Adet / m / Quantity / m	10																
Ağırlık / Weight	11,738 kg																
m ³ / Volume	0,10181																
 <p>001 057 100024 00 00 Alev Yaymayan Non Flammable</p> <p>24 'lü Sıva Üstü W Otomat Kutusu Surface-Mounted Fuse Box , 24 Fuse</p> <table border="1"> <tr> <td>Ambalaj Şekli / Package Type</td> <td>Kutu / Pack</td> </tr> <tr> <td>Adet / m / Quantity / m</td> <td>5</td> </tr> <tr> <td>Ağırlık / Weight</td> <td>7,447 kg</td> </tr> <tr> <td>m³ / Volume</td> <td>0,05507</td> </tr> </table>	Ambalaj Şekli / Package Type	Kutu / Pack	Adet / m / Quantity / m	5	Ağırlık / Weight	7,447 kg	m ³ / Volume	0,05507	 <p>001 057 000024 00 00 Alev Yaymayan Non Flammable</p> <p>24 'lü Sıva Alın W Otomat Kutusu Flush-Mounted Fuse Box , 24 Fuse</p> <table border="1"> <tr> <td>Ambalaj Şekli / Package Type</td> <td>Kutu / Pack</td> </tr> <tr> <td>Adet / m / Quantity / m</td> <td>5</td> </tr> <tr> <td>Ağırlık / Weight</td> <td>6,941 kg</td> </tr> <tr> <td>m³ / Volume</td> <td>0,05507</td> </tr> </table>	Ambalaj Şekli / Package Type	Kutu / Pack	Adet / m / Quantity / m	5	Ağırlık / Weight	6,941 kg	m ³ / Volume	0,05507
Ambalaj Şekli / Package Type	Kutu / Pack																
Adet / m / Quantity / m	5																
Ağırlık / Weight	7,447 kg																
m ³ / Volume	0,05507																
Ambalaj Şekli / Package Type	Kutu / Pack																
Adet / m / Quantity / m	5																
Ağırlık / Weight	6,941 kg																
m ³ / Volume	0,05507																
 <p>001 057 100036 00 00 Alev Yaymayan Non Flammable</p> <p>36 'lı Sıva Üstü W Otomat Kutusu Surface-Mounted Fuse Box , 36 Fuse</p> <table border="1"> <tr> <td>Ambalaj Şekli / Package Type</td> <td>Kutu / Pack</td> </tr> <tr> <td>Adet / m / Quantity / m</td> <td>5</td> </tr> <tr> <td>Ağırlık / Weight</td> <td>9,385 kg</td> </tr> <tr> <td>m³ / Volume</td> <td>0,07306</td> </tr> </table>	Ambalaj Şekli / Package Type	Kutu / Pack	Adet / m / Quantity / m	5	Ağırlık / Weight	9,385 kg	m ³ / Volume	0,07306	 <p>001 057 000036 00 00 Alev Yaymayan Non Flammable</p> <p>36 'lı Sıva Alın W Otomat Kutusu Flush-Mounted Fuse Box , 36 Fuse</p> <table border="1"> <tr> <td>Ambalaj Şekli / Package Type</td> <td>Kutu / Pack</td> </tr> <tr> <td>Adet / m / Quantity / m</td> <td>5</td> </tr> <tr> <td>Ağırlık / Weight</td> <td>8,950 kg</td> </tr> <tr> <td>m³ / Volume</td> <td>0,07306</td> </tr> </table>	Ambalaj Şekli / Package Type	Kutu / Pack	Adet / m / Quantity / m	5	Ağırlık / Weight	8,950 kg	m ³ / Volume	0,07306
Ambalaj Şekli / Package Type	Kutu / Pack																
Adet / m / Quantity / m	5																
Ağırlık / Weight	9,385 kg																
m ³ / Volume	0,07306																
Ambalaj Şekli / Package Type	Kutu / Pack																
Adet / m / Quantity / m	5																
Ağırlık / Weight	8,950 kg																
m ³ / Volume	0,07306																

COMFORT W OTOMAT KUTULARI COMFORT FUSE BOXES

IP40

COMFORT MÜHÜRLÜ SİGORTA KUTULARI SEALED FUSE BOXES

 <p>1 'li Sıva Üstü Mühürlü Sigorta Kutusu Surface Mounted Sealed Fuse Box, 1 Fuse</p> <p>001 057 200001 00 00</p> <table border="1"> <tr> <td>Ambalaj Şekli / Package Type</td> <td>Kutu / Pack</td> </tr> <tr> <td>Adet / m / Quantity / m</td> <td>20</td> </tr> <tr> <td>Ağırlık / Weight</td> <td>1,42 kg</td> </tr> <tr> <td>m³ / Volume</td> <td>0,01096</td> </tr> </table>	Ambalaj Şekli / Package Type	Kutu / Pack	Adet / m / Quantity / m	20	Ağırlık / Weight	1,42 kg	m ³ / Volume	0,01096	 <p>1-2 'li Sıva Üstü Mühürlü Sigorta Kutusu Surface Mounted Sealed Fuse Box, 1-2 Fuses</p> <p>001 057 200002 00 00</p> <table border="1"> <tr> <td>Ambalaj Şekli / Package Type</td> <td>Kutu / Pack</td> </tr> <tr> <td>Adet / m / Quantity / m</td> <td>20</td> </tr> <tr> <td>Ağırlık / Weight</td> <td>1,75 kg</td> </tr> <tr> <td>m³ / Volume</td> <td>0,01412</td> </tr> </table>	Ambalaj Şekli / Package Type	Kutu / Pack	Adet / m / Quantity / m	20	Ağırlık / Weight	1,75 kg	m ³ / Volume	0,01412	 <p>3-4 'li Sıva Üstü Mühürlü Sigorta Kutusu Surface Mounted Sealed Fuse Box, 3-4 Fuses</p> <p>001 057 200004 00 00</p> <table border="1"> <tr> <td>Ambalaj Şekli / Package Type</td> <td>Kutu / Pack</td> </tr> <tr> <td>Adet / m / Quantity / m</td> <td>10</td> </tr> <tr> <td>Ağırlık / Weight</td> <td>1,212 kg</td> </tr> <tr> <td>m³ / Volume</td> <td>0,01117</td> </tr> </table>	Ambalaj Şekli / Package Type	Kutu / Pack	Adet / m / Quantity / m	10	Ağırlık / Weight	1,212 kg	m ³ / Volume	0,01117
Ambalaj Şekli / Package Type	Kutu / Pack																									
Adet / m / Quantity / m	20																									
Ağırlık / Weight	1,42 kg																									
m ³ / Volume	0,01096																									
Ambalaj Şekli / Package Type	Kutu / Pack																									
Adet / m / Quantity / m	20																									
Ağırlık / Weight	1,75 kg																									
m ³ / Volume	0,01412																									
Ambalaj Şekli / Package Type	Kutu / Pack																									
Adet / m / Quantity / m	10																									
Ağırlık / Weight	1,212 kg																									
m ³ / Volume	0,01117																									

COMFORT MÜHÜRLÜ SİGORTA KUTULARI (ALEV YAYMAYAN) MEKS SERIES SEALED FUSE BOXES (NON FLAMMABLE)

 <p>1 'li Sıva Üstü Mühürlü Sigorta Kutusu Surface Mounted Sealed Fuse Box, 1 Fuse</p> <p>001 057 210001 00 00</p> <table border="1"> <tr> <td>Ambalaj Şekli / Package Type</td> <td>Kutu / Pack</td> </tr> <tr> <td>Adet / m / Quantity / m</td> <td>20</td> </tr> <tr> <td>Ağırlık / Weight</td> <td>1,62 kg</td> </tr> <tr> <td>m³ / Volume</td> <td>0,01096</td> </tr> </table>	Ambalaj Şekli / Package Type	Kutu / Pack	Adet / m / Quantity / m	20	Ağırlık / Weight	1,62 kg	m ³ / Volume	0,01096	 <p>1-2 'li Sıva Üstü Mühürlü Sigorta Kutusu Surface Mounted Sealed Fuse Box, 1-2 Fuses</p> <p>001 057 210002 00 00</p> <table border="1"> <tr> <td>Ambalaj Şekli / Package Type</td> <td>Kutu / Pack</td> </tr> <tr> <td>Adet / m / Quantity / m</td> <td>20</td> </tr> <tr> <td>Ağırlık / Weight</td> <td>1,91 kg</td> </tr> <tr> <td>m³ / Volume</td> <td>0,01412</td> </tr> </table>	Ambalaj Şekli / Package Type	Kutu / Pack	Adet / m / Quantity / m	20	Ağırlık / Weight	1,91 kg	m ³ / Volume	0,01412	 <p>3-4 'li Sıva Üstü Mühürlü Sigorta Kutusu Surface Mounted Sealed Fuse Box, 3-4 Fuses</p> <p>001 057 210004 00 00</p> <table border="1"> <tr> <td>Ambalaj Şekli / Package Type</td> <td>Kutu / Pack</td> </tr> <tr> <td>Adet / m / Quantity / m</td> <td>10</td> </tr> <tr> <td>Ağırlık / Weight</td> <td>1,275 kg</td> </tr> <tr> <td>m³ / Volume</td> <td>0,01117</td> </tr> </table>	Ambalaj Şekli / Package Type	Kutu / Pack	Adet / m / Quantity / m	10	Ağırlık / Weight	1,275 kg	m ³ / Volume	0,01117
Ambalaj Şekli / Package Type	Kutu / Pack																									
Adet / m / Quantity / m	20																									
Ağırlık / Weight	1,62 kg																									
m ³ / Volume	0,01096																									
Ambalaj Şekli / Package Type	Kutu / Pack																									
Adet / m / Quantity / m	20																									
Ağırlık / Weight	1,91 kg																									
m ³ / Volume	0,01412																									
Ambalaj Şekli / Package Type	Kutu / Pack																									
Adet / m / Quantity / m	10																									
Ağırlık / Weight	1,275 kg																									
m ³ / Volume	0,01117																									

COMFORT MÜHÜRLÜ SİGORTA KUTULARI H.FREE (ALEV YAYAN) MEKS SERIES SEALED FUSE BOXES H.FREE (FLAMMABLE)

 <p>1 'li Sıva Üstü Mühürlü Sigorta Kutusu Surface Mounted Sealed Fuse Box, 1 Fuse</p> <p></p> <p>001 057 220001 00 00</p> <table border="1"> <tr> <td>Ambalaj Şekli / Package Type</td> <td>Kutu / Pack</td> </tr> <tr> <td>Adet / m / Quantity / m</td> <td>20</td> </tr> <tr> <td>Ağırlık / Weight</td> <td>1,42 kg</td> </tr> <tr> <td>m³ / Volume</td> <td>0,01096</td> </tr> </table>	Ambalaj Şekli / Package Type	Kutu / Pack	Adet / m / Quantity / m	20	Ağırlık / Weight	1,42 kg	m ³ / Volume	0,01096	 <p>1-2 'li Sıva Üstü Mühürlü Sigorta Kutusu Surface Mounted Sealed Fuse Box, 1-2 Fuses</p> <p></p> <p>001 057 220002 00 00</p> <table border="1"> <tr> <td>Ambalaj Şekli / Package Type</td> <td>Kutu / Pack</td> </tr> <tr> <td>Adet / m / Quantity / m</td> <td>20</td> </tr> <tr> <td>Ağırlık / Weight</td> <td>1,75 kg</td> </tr> <tr> <td>m³ / Volume</td> <td>0,01412</td> </tr> </table>	Ambalaj Şekli / Package Type	Kutu / Pack	Adet / m / Quantity / m	20	Ağırlık / Weight	1,75 kg	m ³ / Volume	0,01412	 <p>3-4 'li Sıva Üstü Mühürlü Sigorta Kutusu Surface Mounted Sealed Fuse Box, 3-4 Fuses</p> <p></p> <p>001 057 220004 00 00</p> <table border="1"> <tr> <td>Ambalaj Şekli / Package Type</td> <td>Kutu / Pack</td> </tr> <tr> <td>Adet / m / Quantity / m</td> <td>10</td> </tr> <tr> <td>Ağırlık / Weight</td> <td>0,94 kg</td> </tr> <tr> <td>m³ / Volume</td> <td>0,01117</td> </tr> </table>	Ambalaj Şekli / Package Type	Kutu / Pack	Adet / m / Quantity / m	10	Ağırlık / Weight	0,94 kg	m ³ / Volume	0,01117
Ambalaj Şekli / Package Type	Kutu / Pack																									
Adet / m / Quantity / m	20																									
Ağırlık / Weight	1,42 kg																									
m ³ / Volume	0,01096																									
Ambalaj Şekli / Package Type	Kutu / Pack																									
Adet / m / Quantity / m	20																									
Ağırlık / Weight	1,75 kg																									
m ³ / Volume	0,01412																									
Ambalaj Şekli / Package Type	Kutu / Pack																									
Adet / m / Quantity / m	10																									
Ağırlık / Weight	0,94 kg																									
m ³ / Volume	0,01117																									

COMFORT W Otomat Zayıf akım kutusu

Comfort fuse and
low-current
boxes



İkisi bir arada

Hem sigorta kutusu hem zayıf akım kutusu

- İçerisine Modem, Acces Point, Switch, Tv Dağıtıcı ve cihazların enerji beslemesi için grup priz montajı yapılabilen zayıf akım kutuları ile elektrik ve data tesisatlarındaki karmaşıklığı minimize etmek, arıza tespitini hızlı bir şekilde çözüme kavuşturmak mümkündür.
- Kullanacağınız cihaz sayısına göre farklı ebatlardaki zayıf akım kutularımız, tabanı sac - kapağı plastik ya da tamamı sac olan seçenekleriyle ürün gamımıza eklenmiştir

Two in One

Both the fuse box and the weak current box

- It is possible to minimize the complexity of electrical and data installations and solve the problem quickly with Modem, Access Point, Switch, TV Distributor and weak current boxes which can be grouped for power supply of devices.
- Depending on the number of devices you will use, our product range has been added with the choices of low current boxes in different sizes, sheet metal - cover plastic or all sheet metal.





BOYUTLAR • DIMENSIONS

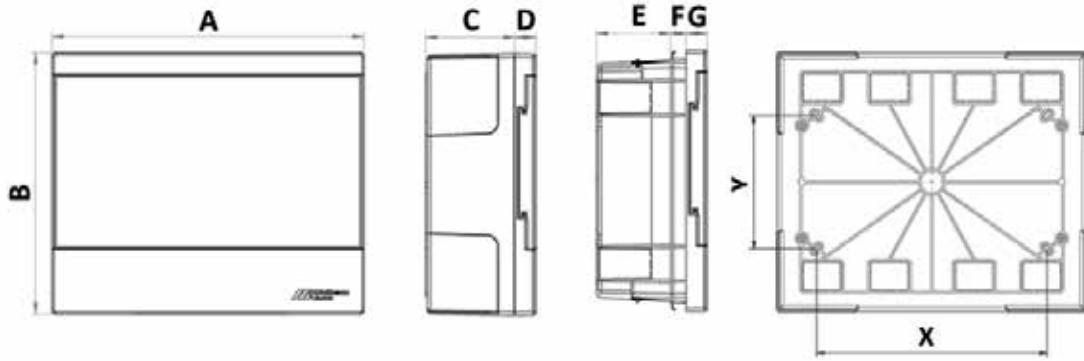

ÖLÇÜLER / SIZES	SIVA ALTI FLUSH	A	B	C	D	E	F	G	X	Y	
		ZAYIF AKIM 205 X 250 (İÇ ÖLÇÜ)	275	230			65,5	13,5	18,5		
		ZAYIF AKIM 248 X 318 (İÇ ÖLÇÜ)	275	345			65,5	13,5	18,5		
		12 SİGORTA + ZAYIF AKIM	275	345			65,5	13,5	18,5		
	24 SİGORTA + ZAYIF AKIM	275	460			65,5	13,5	18,5			
	SIVA ÜSTÜ SURFACE	A	B	C	D	E	F	G	X	Y	
		ZAYIF AKIM 205 X 250 (İÇ ÖLÇÜ)	275	230	78,8	18,5				204	118
		ZAYIF AKIM 248 X 318 (İÇ ÖLÇÜ)	275	345	78,8	18,5				204	233
		12 SİGORTA + ZAYIF AKIM	275	345	78,8	18,5				204	233
		24 SİGORTA + ZAYIF AKIM	275	460	78,8	18,5				204	348

AKSESUAR • ACCESSORY



001 057 001236 00 00

COMFORT ZAYIF AKIM ÖRTME PARÇASI
COMFORT COVER TOOL

Ambalaj Şekli / Package Type	Kutu / Pack
Adet / m / Quantity / m	50
Ağırlık / Weight	0.46 kg
m ³ / Volume	0.001

COMFORT W OTOMAT ZAYIF AKIM KUTULARI

COMFORT FUSE AND LOW-CURRENT BOXES

001 057 101012 00 00

Sıva Üstü Zayıf Akım Kutusu (225x270)
Surface Mounted Low Current Box (225x270)



Ambalaj Şekli / Package Type	Kutu / Pack
Adet / m / Quantity / m	10
Ağırlık / Weight	8,21 kg
m ³ / Volume	0,07207

001 057 001012 00 00

Sıva Altı Zayıf Akım Kutusu (225x270)
Flush Mounted Low Current Box (225x270)



Ambalaj Şekli / Package Type	Kutu / Pack
Adet / m / Quantity / m	10
Ağırlık / Weight	8,445 kg
m ³ / Volume	0,07207

001 057 101020 00 00

Sıva Üstü Zayıf Akım Kutusu (270x340)
Surface Mounted Low Current Box (270x340)



Ambalaj Şekli / Package Type	Kutu / Pack
Adet / m / Quantity / m	5
Ağırlık / Weight	6,94 kg
m ³ / Volume	0,05507

001 057 001020 00 00

Sıva Altı Zayıf Akım Kutusu (270x340)
Flush Mounted Low Current Box (270x340)



Ambalaj Şekli / Package Type	Kutu / Pack
Adet / m / Quantity / m	5
Ağırlık / Weight	6,94 kg
m ³ / Volume	0,05507

001 057 101024 00 00

Sıva Üstü 12'li Sigorta +Zayıf Akım Kutusu
Surface Mounted Fuse Box (12)+
Low Current Box

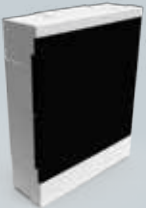

Ambalaj Şekli / Package Type	Kutu / Pack
Adet / m / Quantity / m	5
Ağırlık / Weight	6,835 kg
m ³ / Volume	0,05507

001 057 001024 00 00

Sıva Altı 12'li Sigorta +Zayıf Akım Kutusu
Flush Mounted Fuse Box (12)+
Low Current Box



Ambalaj Şekli / Package Type	Kutu / Pack
Adet / m / Quantity / m	5
Ağırlık / Weight	6,835 kg
m ³ / Volume	0,05507

001 057 101036 00 00

Sıva Üstü 24'lü Sigorta +Zayıf Akım Kutusu
Surface Mounted Fuse Box (24)+
Low Current Box

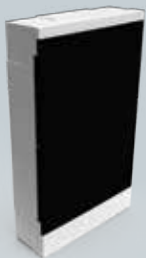

Ambalaj Şekli / Package Type	Kutu / Pack
Adet / m / Quantity / m	5
Ağırlık / Weight	9,39 kg
m ³ / Volume	0,07306

001 057 001036 00 00

Sıva Altı 24'lü Sigorta +Zayıf Akım Kutusu
Flush Mounted Fuse Box (24)+
Low Current Box



Ambalaj Şekli / Package Type	Kutu / Pack
Adet / m / Quantity / m	5
Ağırlık / Weight	9,39 kg
m ³ / Volume	0,07306

COMFORT W OTOMAT ZAYIF AKIM KUTULARI (ALEV YAYMAYAN) COMFORT FUSE AND LOW-CURRENT BOXES (NON FLAMMABLE)

IP40

001 057 111012 00 00

Alev Yaymayan
Non Flammable

Sıva Üstü Zayıf Akım Kutusu (225x270)
Surface Mounted Low Current Box (225x270)

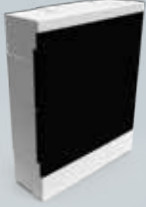

Ambalaj Şekli / Package Type	Kutu / Pack
Adet / m / Quantity / m	10
Ağırlık / Weight	8,21 kg
m ³ / Volume	0,07207

001 057 011012 00 00

Alev Yaymayan
Non Flammable

Sıva Altı Zayıf Akım Kutusu (225x270)
Flush Mounted Low Current Box (225x270)



Ambalaj Şekli / Package Type	Kutu / Pack
Adet / m / Quantity / m	10
Ağırlık / Weight	8,445 kg
m ³ / Volume	0,07207

001 057 111020 00 00

Alev Yaymayan
Non Flammable

Sıva Üstü Zayıf Akım Kutusu (270x340)
Surface Mounted Low Current Box (270x340)

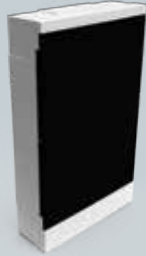

Ambalaj Şekli / Package Type	Kutu / Pack
Adet / m / Quantity / m	5
Ağırlık / Weight	6,94 kg
m ³ / Volume	0,05507

001 057 011020 00 00

Alev Yaymayan
Non Flammable

Sıva Altı Zayıf Akım Kutusu (270x340)
Flush Mounted Low Current Box (270x340)



Ambalaj Şekli / Package Type	Kutu / Pack
Adet / m / Quantity / m	5
Ağırlık / Weight	6,94 kg
m ³ / Volume	0,05507

001 057 111024 00 00

Alev Yaymayan
Non Flammable

Sıva Üstü 12'li Sigorta +Zayıf Akım Kutusu
Surface Mounted Fuse Box (12)+
Low Current Box

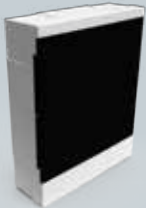

Ambalaj Şekli / Package Type	Kutu / Pack
Adet / m / Quantity / m	5
Ağırlık / Weight	6,835 kg
m ³ / Volume	0,05507

001 057 011024 00 00

Alev Yaymayan
Non Flammable

Sıva Altı 12'li Sigorta +Zayıf Akım Kutusu
Flush Mounted Fuse Box (12)+
Low Current Box



Ambalaj Şekli / Package Type	Kutu / Pack
Adet / m / Quantity / m	5
Ağırlık / Weight	6,835 kg
m ³ / Volume	0,05507

001 057 111036 00 00

Alev Yaymayan
Non Flammable

Sıva Üstü 24'lü Sigorta +Zayıf Akım Kutusu
Surface Mounted Fuse Box (24)+
Low Current Box

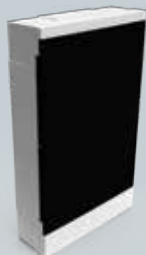

Ambalaj Şekli / Package Type	Kutu / Pack
Adet / m / Quantity / m	5
Ağırlık / Weight	9,39 kg
m ³ / Volume	0,07306

001 057 011036 00 00

Alev Yaymayan
Non Flammable

Sıva Altı 24'lü Sigorta +Zayıf Akım Kutusu
Flush Mounted Fuse Box (24)+
Low Current Box



Ambalaj Şekli / Package Type	Kutu / Pack
Adet / m / Quantity / m	5
Ağırlık / Weight	9,39 kg
m ³ / Volume	0,07306

COMFORT W OTOMAT ZAYIF AKIM KUTULARI H. FREE (ALEV YAYAN) COMFORT FUSE AND LOW-CURRENT BOXES H.FREE (FLAMMABLE)

IP40

001 057 121012 00 00

Alev Yayan
Flammable

Sıva Üstü Zayıf Akım Kutusu (225x270)
Surface Mounted Low Current Box (225x270)



Ambalaj Şekli / Package Type	Kutu / Pack
Adet / m / Quantity / m	10
Ağırlık / Weight	8,21 kg
m ³ / Volume	0,07207

001 057 021012 00 00

Alev Yayan
Flammable

Sıva Altı Zayıf Akım Kutusu (225x270)
Flush Mounted Low Current Box (225x270)



Ambalaj Şekli / Package Type	Kutu / Pack
Adet / m / Quantity / m	10
Ağırlık / Weight	8,445 kg
m ³ / Volume	0,07207

001 057 121020 00 00

Alev Yayan
Flammable

Sıva Üstü Zayıf Akım Kutusu (270x340)
Surface Mounted Low Current Box (270x340)



Ambalaj Şekli / Package Type	Kutu / Pack
Adet / m / Quantity / m	5
Ağırlık / Weight	6,94 kg
m ³ / Volume	0,05507

001 057 021020 00 00

Alev Yayan
Flammable

Sıva Altı Zayıf Akım Kutusu (270x340)
Flush Mounted Low Current Box (270x340)



Ambalaj Şekli / Package Type	Kutu / Pack
Adet / m / Quantity / m	5
Ağırlık / Weight	6,94 kg
m ³ / Volume	0,05507

001 057 121024 00 00

Alev Yayan
Flammable

Sıva Üstü 12'li Sigorta +Zayıf Akım Kutusu
Surface Mounted Fuse Box (12)+
Low Current Box

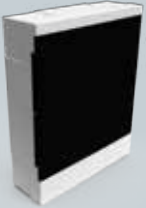

Ambalaj Şekli / Package Type	Kutu / Pack
Adet / m / Quantity / m	5
Ağırlık / Weight	6,835 kg
m ³ / Volume	0,05507

001 057 021024 00 00

Alev Yayan
Flammable

Sıva Altı 12'li Sigorta +Zayıf Akım Kutusu
Flush Mounted Fuse Box (12)+
Low Current Box



Ambalaj Şekli / Package Type	Kutu / Pack
Adet / m / Quantity / m	5
Ağırlık / Weight	6,835 kg
m ³ / Volume	0,05507

001 057 121036 00 00

Alev Yayan
Flammable

Sıva Üstü 24'lü Sigorta +Zayıf Akım Kutusu
Surface Mounted Fuse Box (24)+
Low Current Box

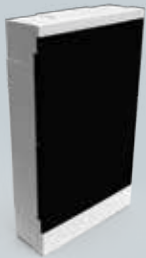

Ambalaj Şekli / Package Type	Kutu / Pack
Adet / m / Quantity / m	5
Ağırlık / Weight	9,39 kg
m ³ / Volume	0,07306

001 057 021036 00 00

Alev Yayan
Flammable

Sıva Altı 24'lü Sigorta +Zayıf Akım Kutusu
Flush Mounted Fuse Box (24)+
Low Current Box



Ambalaj Şekli / Package Type	Kutu / Pack
Adet / m / Quantity / m	5
Ağırlık / Weight	9,39 kg
m ³ / Volume	0,07306

COMFORT W OTOMAT ZAYIF AKIM KUTULARI (METAL)

METAL COMFORT MCB LOW CURRENT BOX



001 058 000012 00 00 **12'li Sıva Altı Metal Tabanlı + Plastik Kapaklı Otomatik Sigorta Kutusu**
Distribution Box - 12 Modules Metal Base + Plastic Cover Flush Type

001 058 001012 00 00 **Sıva Altı Metal Tabanlı + Plastik Kapaklı Zayıf Akım Kutusu**
Low Current Box Metal Base + Plastic Cover Flush Type

Ankastre Ölçüsü / Mounting Dimension 210 x 252 x 80 mm

Ürün Ölçüsü / Product Dimension 230 x 275 x 102 mm

Tekli Kutu Ölçüsü / Single Box Dimension 281x 238 x 104 mm

Ağırlık / Weight 2,02 Kg.



001 058 000024 00 00 **24'lü Sıva Altı Metal Tabanlı + Plastik Kapaklı Otomatik Sigorta Kutusu**
Distribution Box - 24 Modules Metal Base + Plastic Cover Flush Type

001 058 001024 00 00 **12 Sigortalı + Zayıf Akım Bölmeli Sıva Altı Metal Tabanlı + Plastik Kapaklı Kutu**
Distribution Box 12 Modules + Low Current Box Metal Base + Plastic Cover Flush Type

001 058 502532 00 00 **250 x 320 mm Sıva Altı Metal Tabanlı + Plastik Kapaklı Zayıf Akım Kutusu**
Low Current Box 250 x320mm Metal Base + Plastic Cover Flush Type

Ankastre Ölçüsü / Mounting Dimension 255 x 324 x 80 mm

Ürün Ölçüsü / Product Dimension 275 x 345 x 102 mm

Tekli Kutu Ölçüsü / Single Box Dimension 350 x 283 x 104 mm

Ağırlık / Weight 2,95 Kg.



001 058 000036 00 00 **36'lı Sıva Altı Metal Tabanlı + Plastik Kapaklı Otomatik Sigorta Kutusu**
Distribution Box - 36 Modules Metal Base + Plastic Cover Flush Type

001 058 001036 00 00 **24 Sigortalı + Zayıf Akım Bölmeli Sıva Altı Metal Tabanlı + Plastik Kapaklı Kutu**
Distribution Box 24 Modules + Low Current Box Metal Base + Plastic Cover Flush Type

Ankastre Ölçüsü / Mounting Dimension 255 x 440 x 80 mm

Ürün Ölçüsü / Product Dimension 275 x 46 x 102 mm

Tekli Kutu Ölçüsü / Single Box Dimension 465 x 282 x 105 mm

Ağırlık / Weight 3,85 Kg.



001 058 602532 00 00 **250 mm x 320 mm Sıva Altı Zayıf Akım Kutusu**
Metal Low Current Box 250 mm x 320 mm Flush Type

Ankastre Ölçüsü / Mounting Dimension 250 x 320 x 73 mm

Ambalaj Ölçüsü / Box Dimension 460 x 300 x 110 mm

Ağırlık / Weight 3.70 Kg.

COMFORT W OTOMAT ZAYIF AKIM KUTULARI (METAL)

METAL COMFORT MCB LOW CURRENT BOX



001 058 602544 00 00 **250 mm x 440 mm Metal Sıva Altı Zayıf Akım Kutusu**
Metal Low Current Box 250 mm x 440 mm Flush Type

Ankastre Ölçüsü / Mounting Dimension	250 x 440 x 73 mm
Ambalaj Ölçüsü / Box Dimension	570 x 300 x 110 mm
Ağırlık / Weight	4,70 Kg.



001 058 604040 00 00 **400 x 400 mm Sıva Altı Metal Zayıf Akım Kutusu**
Metal Low Current Box 400 x 400 mm Lush Type

Ankastre Ölçüsü / Mounting Dimension	400 x 400 x 73 mm
Ambalaj Ölçüsü / Box Dimension	520 x 520 x 110 mm
Ağırlık / Weight	6.50 Kg.



001 058 400036 00 00 **24 Sigortalı + Zayıf Akım Bölmeli Sıva Altı Metal Kutu**
Metal Distribution Box 24 Modules + Low Current Box Flush Type

Ankastre Ölçüsü / Mounting Dimension	700 x 300 x 80 mm
Ambalaj Ölçüsü / Box Dimension	730 x 330 x 110 mm
Ağırlık / Weight	9,50 Kg.



001 058 400048 00 00 **36 Sigortalı + Zayıf Akım Bölmeli Sıva Altı Metal Kutu**
Metal Distribution Box 36 Modules + Low Current Box Flush Type

Ankastre Ölçüsü / Mounting Dimension	730 x 450 x 80 mm
Ambalaj Ölçüsü / Box Dimension	780 x 500 x 110 mm
Ağırlık / Weight	11,90 Kg.

MEKSBOX

W Otomat kutuları

Fuse boxes



ÖLÇÜLER (mm) DIMENSIONS

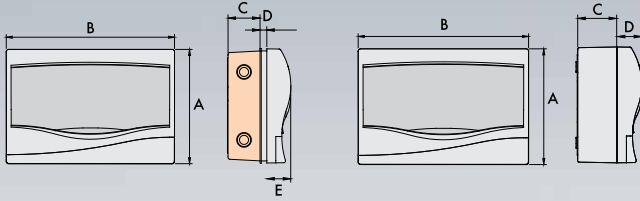

SIVAALTI W OTOMAT KUTULARI FLUSH MOUNTED FUSE BOXES

	A	B	C	D	E
2' li	142	93	53.5	11,5	40
4'lü	142	138	53.5	11,5	40
6'lı	142	163	53.5	11,5	40
9'lu	172	217	53.5	11,5	40
12'li	182	272	53.5	11,5	40
16'lı	272	207	53.5	11,5	40
24'lü	332	272	53.5	11,5	40
36'lı	482	272	53.5	11,5	40

SIVAÜSTÜ W OTOMAT KUTULARI SURFACE MOUNTED FUSE BOXES

	A	B	C	D
2' li	149	100	65	40
4'lü	150	150	65	40
6'lı	150	170	65	40
9'lu	180	225	65	40
12'li	190	280	65	40
16'lı	290	215	65	40
24'lü	340	280	65	40
36'lı	490	280	65	40

Terminal koruma seviyesi (Koruma sınıfı) Terminal protection level (Protection class)	IP 30 IP 30
Kutuların tipi Type of boxes	Dikdörtgen kutulardır. Rectangular box
Tesis sırasındaki sıcaklık aralığı Temperature range during installation	-25°C / +60°C -25°C / +60°C
Yalıtım direnci Insulation resistance	5 MΩ'un üzerindedir. Over 5 m Ohm
Yüksek gerilime dayanımı Resistance to high voltage	3750 V AC (Alternatif akım, 220 / 400 V-50 Hz) 3750 V AC (Alternating Current, 220/400 V-50 Hz)

TESİS VE UYGULAMA

Sağlam, yanmaz duvarda ve tavanda kullanıma uygundur.
İnşaat sırasında ve inşaat işleminden sonra montaja elverişlidir.

Sert, yanabilir duvarlarda ve tavanda kullanıma uygundur.

Beton içerisi hariç tüm montaj tipleri için uygundur.

Kutuların sivaüstü ve sivaaltı tespiti son derece kolay yapılabilecek şekilde tasarlanmıştır.

Kutular elektriksel korumayı sağlayacak şekilde tasarlanmıştır.

Kutuların giriş delikleri boru girişine uygundur.

Kutuların normal kullanım sürecinde oluşabilecek yaşlanma ve nemli şartlara karşı dayanıklılığı, kullanılan metal malzemelerin paslanmaya karşı dayanıklılığı, sızdırmazlık ve aşınma testleri ve elektrik çarpmasına karşı koruma testleri, ısıya dayanıklılık testleri, mekanik dayanıklılık testleri ve olağan dışı ısıya karşı dayanıklılık testleri TS EN 60670-1/ARALIK 2015 standard kapsamında yapılan yeterlilik testleri ile doğrulanmıştır.

INSTALLATION AND APPLICATION

Fuse boxes are suitable for use on sound and fireproof walls and ceilings. The fuse boxes are suitable for installation during and after construction works.

Suitable for application on solid and combustible walls and ceilings.

Suitable for all installation types except for concrete-embedded applications.

The fuse boxes are designed for easy flush-mounted and surface mounted installation.

Fuse boxes are designed to provide electrical protection.

Inlet ports of the fuse boxes are compatible for pipe installation.

The resistance of the fuse boxes against ageing and humidity conditions that might occur during normal use, resistance of the metals used against oxidation are validated by means of permeability and abrasion tests, tests for resistance to temperature, mechanical endurance tests and extraordinary heat resistance tests conducted under the scope of TS EN 60670-1/DECEMBER 2005 standard

SIVAÜSTÜ W OTOMAT KUTULARI

SURFACE MOUNTED FUSE BOXES

IP 30



001 027 110002 00 00

Alev Yaymayan
Non Flammable

001 027 100002 00 00

Alev Yayan
Flammable

1-2 'li Siva Üstü W Otomat Kutusu
Surface-Mounted Fuse Box , 1-2 Fuse

Ambalaj Şekli / Package Type	Kutu / Pack
Adet / m / Quantity / m	30
Ağırlık / Weight	9,933 / 9,459 kg
m ³ / Volume	0,05700

SIVAALTI W OTOMAT KUTULARI

FLUSH MOUNTED FUSE BOXES

IP 30



001 027 010002 00 00

Alev Yaymayan
Non Flammable

001 027 000002 00 00

Alev Yayan
Flammable

1-2 'li Siva Altı W Otomat Kutusu
Flush-Mounted Fuse Box , 1-2 Fuse

Ambalaj Şekli / Package Type	Kutu / Pack
Adet / m / Quantity / m	30
Ağırlık / Weight	9,398 / 8,949 kg
m ³ / Volume	0,05700



001 027 110004 00 00

Alev Yaymayan
Non Flammable

001 027 100004 00 00

Alev Yayan
Flammable

3-4 'lü Siva Üstü W Otomat Kutusu
Surface-Mounted Fuse Box , 3-4 Fuse

Ambalaj Şekli / Package Type	Kutu / Pack
Adet / m / Quantity / m	20
Ağırlık / Weight	8,274 / 7,880 kg
m ³ / Volume	0,05400



001 027 010004 00 00

Alev Yaymayan
Non Flammable

001 027 000004 00 00

Alev Yayan
Flammable

3-4 'lü Siva Altı W Otomat Kutusu
Flush-Mounted Fuse Box , 3-4 Fuse

Ambalaj Şekli / Package Type	Kutu / Pack
Adet / m / Quantity / m	20
Ağırlık / Weight	7,880 / 7,506 kg
m ³ / Volume	0,05400



001 027 110006 00 00

Alev Yaymayan
Non Flammable

001 027 100006 00 00

Alev Yayan
Flammable

2-6 'lı Siva Üstü W Otomat Kutusu
Surface-Mounted Fuse Box , 2-6 Fuse

Ambalaj Şekli / Package Type	Kutu / Pack
Adet / m / Quantity / m	20
Ağırlık / Weight	10,143 / 9,660 kg
m ³ / Volume	0,06400



001 027 010006 00 00

Alev Yaymayan
Non Flammable

001 027 000006 00 00

Alev Yayan
Flammable

2-6 'lı Siva Altı W Otomat Kutusu
Flush-Mounted Fuse Box , 2-6 Fuse

Ambalaj Şekli / Package Type	Kutu / Pack
Adet / m / Quantity / m	20
Ağırlık / Weight	9,550 / 9,096 kg
m ³ / Volume	0,06400



001 027 110009 00 00

Alev Yaymayan
Non Flammable

001 027 100009 00 00

Alev Yayan
Flammable

9 'lu Siva Üstü W Otomat Kutusu
Surface-Mounted Fuse Box , 9 Fuse

Ambalaj Şekli / Package Type	Kutu / Pack
Adet / m / Quantity / m	20
Ağırlık / Weight	14,065 / 13,396 kg
m ³ / Volume	0,10000



001 027 010009 00 00

Alev Yaymayan
Non Flammable

001 027 000009 00 00

Alev Yayan
Flammable

9 'lu Siva Altı W Otomat Kutusu
Flush-Mounted Fuse Box , 9 Fuse

Ambalaj Şekli / Package Type	Kutu / Pack
Adet / m / Quantity / m	20
Ağırlık / Weight	13,582 / 12,936 kg
m ³ / Volume	0,10000

SIVAÜSTÜ W OTOMAT KUTULARI
SURFACE MOUNTED FUSE BOXES

IP 30

SIVAALTI W OTOMAT KUTULARI
FLUSH MOUNTED FUSE BOXES

IP 30

   **001 027 110012 00 00** Alev Yaymayan
Non Flammable**001 027 100012 00 00** Alev Yayan
Flammable**12 'li Sıva Üstü W Otomat Kutusu**
Surface-Mounted Fuse Box , 12 Fuse

Ambalaj Şekli / Package Type	Kutu / Pack
Adet / m / Quantity / m	10
Ağırlık / Weight	8,400 / 8,290 kg
m ³ / Volume	0,06400

   **001 027 010012 00 00** Alev Yaymayan
Non Flammable**001 027 000012 00 00** Alev Yayan
Flammable**12 'li Sıva Altı W Otomat Kutusu**
Flush-Mounted Fuse Box , 12 Fuse



Ambalaj Şekli / Package Type	Kutu / Pack
Adet / m / Quantity / m	10
Ağırlık / Weight	8,850 / 8,380 kg
m ³ / Volume	0,06400

   **001 027 110016 00 00** Alev Yaymayan
Non Flammable**001 027 100016 00 00** Alev Yayan
Flammable**16 'li Sıva Üstü W Otomat Kutusu**
Surface-Mounted Fuse Box , 16 Fuse



Ambalaj Şekli / Package Type	Kutu / Pack
Adet / m / Quantity / m	10
Ağırlık / Weight	11,015 / 10,490 kg
m ³ / Volume	0,07300

   **001 027 010016 00 00** Alev Yaymayan
Non Flammable**001 027 000016 00 00** Alev Yayan
Flammable**16 'li Sıva Altı W Otomat Kutusu**
Flush-Mounted Fuse Box , 16 Fuse

Ambalaj Şekli / Package Type	Kutu / Pack
Adet / m / Quantity / m	10
Ağırlık / Weight	10,238 / 9,750 kg
m ³ / Volume	0,07300

   **001 027 110024 00 00** Alev Yaymayan
Non Flammable**001 027 100024 00 00** Alev Yayan
Flammable**24 'lü Sıva Üstü W Otomat Kutusu**
Surface-Mounted Fuse Box , 24 Fuse

Ambalaj Şekli / Package Type	Kutu / Pack
Adet / m / Quantity / m	5
Ağırlık / Weight	7,697 / 7,330 kg
m ³ / Volume	0,05700

   **001 027 010024 00 00** Alev Yaymayan
Non Flammable**001 027 000024 00 00** Alev Yayan
Flammable**24 'lü Sıva Altı W Otomat Kutusu**
Flush-Mounted Fuse Box , 24 Fuse

Ambalaj Şekli / Package Type	Kutu / Pack
Adet / m / Quantity / m	5
Ağırlık / Weight	7,534 / 7,175 kg
m ³ / Volume	0,05700

SIVAÜSTÜ W OTOMAT KUTULARI

SURFACE MOUNTED FUSE BOXES

IP 30

SIVAALTI W OTOMAT KUTULARI

FLUSH MOUNTED FUSE BOXES

IP 30



001 027 110036 00 00

Alev Yaymayan
Non Flammable

001 027 100036 00 00

Alev Yayan
Flammable

36 'li Siva Üstü W Otomat Kutusu
Surface-Mounted Fuse Box , 36 Fuse

Ambalaj Şekli / Package Type	Kutu / Pack
Adet / m / Quantity / m	5
Ağırlık / Weight	10,720 / 10,105 kg
m ³ / Volume	0,07595



001 027 010036 00 00

Alev Yaymayan
Non Flammable

001 027 000036 00 00

Alev Yayan
Flammable

36 'li Siva Altı W Otomat Kutusu
Flush-Mounted Fuse Box , 36 Fuse

Ambalaj Şekli / Package Type	Kutu / Pack
Adet / m / Quantity / m	5
Ağırlık / Weight	10,835 / 10,200 kg
m ³ / Volume	0,07595

MEKS SERİSİ MÜHÜRLÜ SİGORTA KUTULARI

MEKS SERIES SEALED FUSE BOXES

IP 30



1 'li Siva Üstü Mühürlü Sigorta Kutusu

Surface Mounted Sealed
Fuse Box , 1 Fuse

001 027 210001 00 00

Alev Yaymayan
Non Flammable

001 027 200001 00 00

Alev Yayan
Flammable

Ambalaj Şekli / Package Type	Kutu / Pack
Adet / m / Quantity / m	160
Ağırlık / Weight	10,208 / 9,728 kg
m ³ / Volume	0,08000



1-2 'li Siva Üstü Mühürlü Sigorta Kutusu

Surface Mounted Sealed
Fuse Box , 1-2 Fuse

001 027 210002 00 00

Alev Yaymayan
Non Flammable

001 027 200002 00 00

Alev Yayan
Flammable

Ambalaj Şekli / Package Type	Kutu / Pack
Adet / m / Quantity / m	80
Ağırlık / Weight	6,500 / 6,192 kg
m ³ / Volume	0,04800



3-4 'li Siva Üstü Mühürlü Sigorta Kutusu

Surface Mounted Sealed
Fuse Box , 3-4 Fuse

001 027 210004 00 00

Alev Yaymayan
Non Flammable

001 027 200004 00 00

Alev Yayan
Flammable

Ambalaj Şekli / Package Type	Kutu / Pack
Adet / m / Quantity / m	80
Ağırlık / Weight	8,936 / 8,512 kg
m ³ / Volume	0,08800



TELEFON DAĞITIM KUTULARI VE AKSESUARLARI

TELEPHONE DISTRIBUTION BOXES (HUBS) and ACCESSORIES

	Kod Code	Açıklama Description	Ambalaj Packing	Adet Quantity	Ağırlık Weight	Hacim Volume
 IP 40	Alev Yaymayan Non Flammable    001 049 201020 00 00	Telefon Dağıtım Kutusu 10-20 (Plastik Kilitli) Telephone Distribution Box, 10-20 Hubs (With Plastic Lock)	Kutu Pack	60	20,502 Kg	0,13709
	Alev Yayan Flammable 001 049 001020 00 00					
 IP 40	Alev Yaymayan Non Flammable    001 049 211020 00 00	Telefon Dağıtım Kutusu 10-20 (Kilitli) Telephone Distribution Box, 10-20 Hubs (With Lock)	Kutu Pack	60	21,198 Kg	0,13709
	Alev Yayan Flammable 001 049 011020 00 00					
 IP 40	Alev Yaymayan Non Flammable    001 049 201050 00 00	Telefon Dağıtım Kutusu 10-50 (Plastik Kilitli) Telephone Distribution Box, 10-50 Hubs (With Plastic Lock)	Kutu Pack	28	18,029 Kg	0,13709
	Alev Yayan Flammable 001 049 001050 00 00					
 IP 40	Alev Yaymayan Non Flammable    001 049 211050 00 00	Telefon Dağıtım Kutusu 10-50 (Kilitli) Telephone Distribution Box, 10-50 Hubs (With Lock)	Kutu Pack	28	18,620 Kg	0,13709
	Alev Yayan Flammable 001 049 011050 00 00					
	888 049 050002	Telefon Dağıtım Modülü (Kesmeli) Telephone Distribution Module (With interrupt feature)	Kutu Pack	400	23,200 Kg	0,06200
	888 049 050001	Telefon Dağıtım Modülü (Kesmesiz) 10 Pairs Connection Module	Kutu Pack	400	23,200 Kg	0,06200
	888 049 050003	İrtibatlama Aleti Connection Tool	Kutu Pack	100	10,500 Kg	0,03480
	031 049 040001	Dağıtım Kutusu Tek Jaklı Distribution Box (Single Jack)	Kutu Pack	1	0,023 Kg	0,00006
	031 049 040002	Dağıtım Kutusu Çift Jaklı Distribution Box (Double Jack)	Kutu Pack	1	0,025 Kg	0,00010

TELEFON DAĞITIM KUTULARI VE AKSESUARLARI

TELEPHONE DISTRIBUTION BOXES (HUBS) and ACCESSORIES

	Kod Code	Açıklama Description	Ambalaj Packing	Adet Quantity	Ağırlık Weight	Hacim Volume
	888 049 050008	Data Konnektörü Cat 6e (RJ 45) (8 Kontak Tolles) Data Connector Cat 6e (RJ 45) (8 Contacts)	Kutu Pack	600	8,94 Kg	0,06000
	888 049 050009	Telefon Konnektörü (RJ 11/12) (6 Kontak) Telephone Connector (RJ 11/12) (8 Contacts)	Kutu Pack	200	1,34 Kg	0,00560
	888 049 050018	6P6C İkili Dağıtıcı Telefon Fişi 6P6C Dual Distributor Telephone Plug	Kutu Pack	500	15 Kg	0,03695
	888 049 050019	6P4C Paralel Dağıtıcı 6P4C Parallel Distributor	Kutu Pack	1000	7,5 Kg	0,07390

MODÜL BAĞLANTI ÇATISI MODULE CONNECTION RACK

	Kod Code	Açıklama Description	Ambalaj Packing	Adet Quantity	Ağırlık Weight	Hacim Volume
	001 024 000001 00 00	1 modül için Rack for 1 module	Kutu Pack	1000	25 Kg	0,05100
	001 024 000002 00 00	2 modül için Rack for 2 modules	Kutu Pack	500	24 Kg	0,05100
	001 024 000003 00 00	3 modül için Rack for 3 modules	Kutu Pack	400	27,6 Kg	0,05120
	001 024 000004 00 00	4 modül için Rack for 4 modules	Kutu Pack	300	28,5 Kg	0,05130
	001 024 000005 00 00	5 modül için Rack for 5 modules	Kutu Pack	200	22,94 Kg	0,05120
	001 024 000006 00 00	6 modül için Rack for 6 modules	Kutu Pack	200	25,38 Kg	0,12000
	001 024 000007 00 00	7 modül için Rack for 7 modules	Kutu Pack	150	23,03 Kg	0,09765
	001 024 000008 00 00	8 modül için Rack for 8 modules	Kutu Pack	150	26,26 Kg	0,11025
	001 024 000009 00 00	9 modül için Rack for 9 modules	Kutu Pack	100	19,80 Kg	0,08610
	001 024 000010 00 00	10 modül için Rack for 10 modules	Kutu Pack	100	22,7 Kg	0,08600

**Çelik spiral,
spiral ve borular**
Stell spirals
spirals and pipes

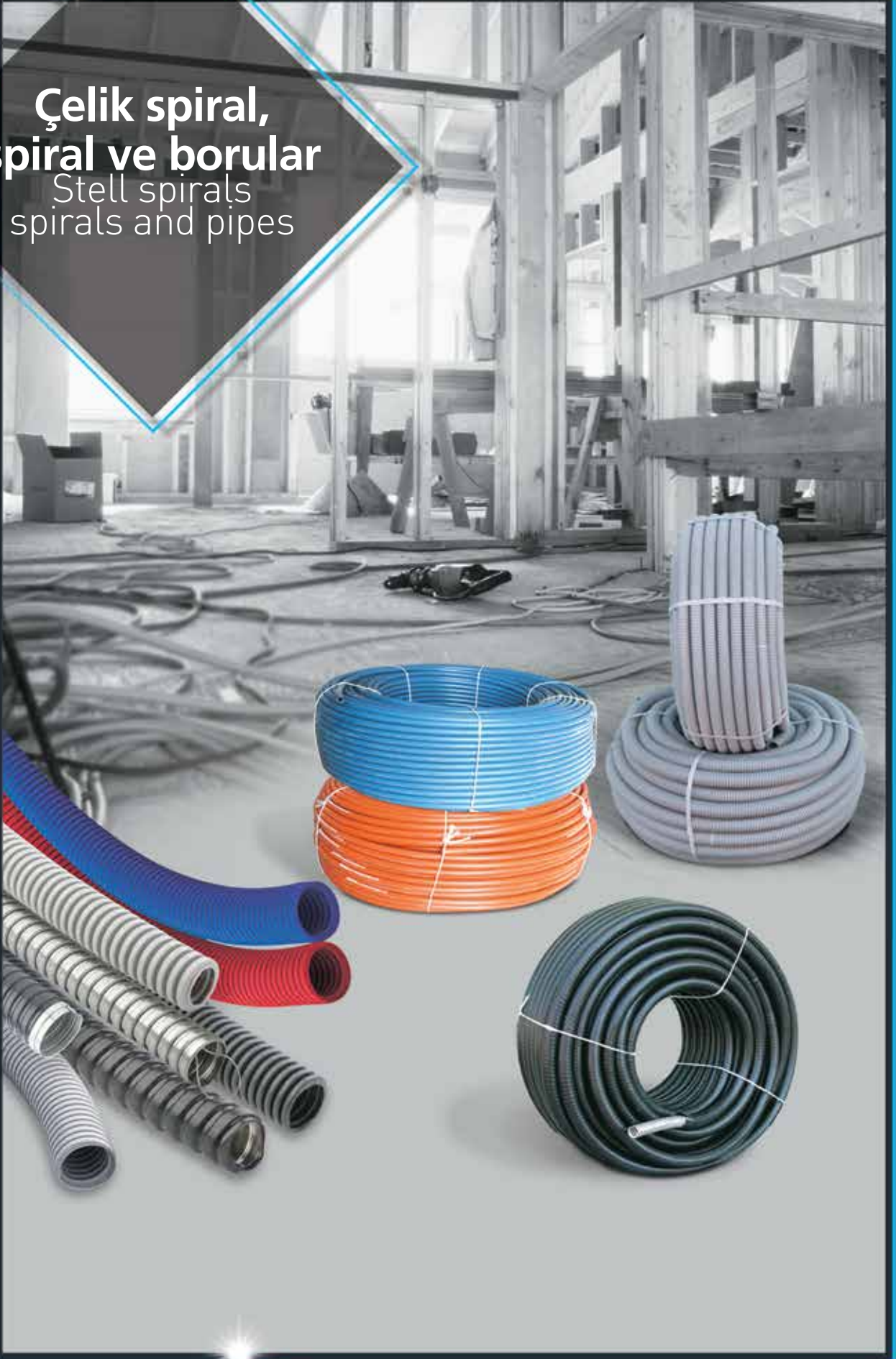

TESİSAT MALZEMELERİ / INSTALLATION MATERIALS

	H.FREE ALEV YAYMAYAN SİRALLER H.FREE NONFLAMMABLE SPIRALS	H.FREE ALEV YAYAN SİRALLER H.FREE FLAMMABLE SPIRALS
Boru tipi Type of the Pipe	Metalik olmayan - oluklu Nonmetallic - Corrugated	Metalik olmayan - oluklu Nonmetallic - Corrugated
Bağlantı metodu Connection method	Diş çekilmemiş Non-threaded	Diş çekilmemiş Non-threaded
Sıkıştırmaya karşı dayanıklılık Compressive Strength	Hafif (320 N) Orta (750 N) Ağır (1250 N) Low (320 N) Medium (750 N) Heavy (1250 N)	Hafif (320 N) Orta (750 N) Ağır (1250 N) Low (320 N) Medium (750 N) Heavy (1250 N)
Darbeye karşı dayanıklılık Impact Resistance	Orta (2 kg, 100 mm) -15°C'de Medium (2 kg, 100 mm) - 15°C	Orta (2 kg, 100 mm) -15°C'de Medium (2 kg, 100 mm) - 15°C
En küçük sürekli uygulama ve tesisat sıcaklığı Minimum continuous application and installation temperature	-15°C -15°C	-15°C -15°C
En büyük sürekli uygulama ve tesisat sıcaklığı Maximum continuous application and installation temperature	+60°C +60°C	+60°C +60°C
Bükülmeye karşı dayanıklılık Flexural Strength	Esnek - kendini toparlayan Flexible-Self recovering	Esnek - kendini toparlayan Flexible-Self recovering
Dış etkenlere karşı dayanıklılık Resistance to external impacts	Katı yabancı cisimlerin girişine karşı korumalı Protected against ingress of solid foreign materials	Katı yabancı cisimlerin girişine karşı korumalı Protected against ingress of solid foreign materials
Alev yayılmasına karşı dayanıklılık Resistance to flame propagation	Alev yaymayan Non-flame-propagating	Alev yayan Flammable

POLYAMİD (PA) ALEV YAYMAYAN SİRALLER POLYAMIDE (PA) NON-FLAME-PROPAGATING SPIRALS

Boru tipi Type of the Pipe	Metalik olmayan - oluklu Nonmetallic - Corrugated
Bağlantı metodu Connection method	Diş çekilmemiş Non-threaded
Sıkıştırmaya karşı dayanıklılık Compressive Strength	Hafif (320 N) Low (320 N)
Darbeye karşı dayanıklılık Impact Resistance	Hafif (1kg, 100 mm) -15°C'de Low (1 kg, 100 mm) - 15°C
En küçük sürekli uygulama ve tesisat sıcaklığı Minimum continuous application and installation temperature	-15°C -15°C
En büyük sürekli uygulama ve tesisat sıcaklığı Maximum continuous application and installation temperature	+105°C +105°C
Bükülmeye karşı dayanıklılık Flexural Strength	Esnek - kendini toparlayan Flexible-Self recovering
Dış etkenlere karşı dayanıklılık Resistance to external impacts	Katı yabancı cisimlerin girişine karşı korumalı Protected against ingress of solid foreign materials
Alev yayılmasına karşı dayanıklılık Resistance to flame propagation	Alev yaymayan Non-flame-propagating

POLİPROPİLEN (PP) SİRALLER POLYPROPYLENE (PP) FLAMMABLE SPIRALS

Boru tipi Type of the Pipe	Metalik olmayan - oluklu Nonmetallic - Corrugated
Bağlantı metodu Connection method	Diş çekilmemiş Non-threaded
Sıkıştırmaya karşı dayanıklılık Compressive Strength	Hafif (320 N) Low (320 N)
Darbeye karşı dayanıklılık Impact Resistance	Hafif (1kg, 100 mm) -15°C'de Low (1 kg, 100 mm) - 15°C
En küçük sürekli uygulama ve tesisat sıcaklığı Minimum continuous application and installation temperature	-15°C -15°C
En büyük sürekli uygulama ve tesisat sıcaklığı Maximum continuous application and installation temperature	+90°C +90°C
Bükülmeye karşı dayanıklılık Flexural Strength	Esnek - kendini toparlayan Flexible-Self recovering
Dış etkenlere karşı dayanıklılık Resistance to external impacts	Katı yabancı cisimlerin girişine karşı korumalı Protected against ingress of solid foreign materials
Alev yayılmasına karşı dayanıklılık Resistance to flame propagation	Alev Yayan Flammable

RİJİT BORULAR RIGID PIPES

Boru tipi Type of the Pipe	Metalik olmayan Nonmetallic
Bağlantı metodu Connection method	Diş çekilmemiş Non-threaded
Sıkıştırmaya karşı dayanıklılık Compressive Strength	H.FREE RİJİT BORULAR Hafif (320 N) Orta (750 N) Ağır (1250 N) RİJİT BORULAR Orta (750 N) H.FREE RIGID PIPES Low (320 N) Medium (750 N) Heavy (1250 N) RIGID PIPES Medium (750 N)
Darbeye karşı dayanıklılık Impact Resistance	Orta (2 Kg, 100 mm) -15°C'de Medium (2 Kg, 100 mm) - 15°C
En küçük sürekli uygulama ve tesisat sıcaklığı Minimum continuous application and installation temperature	-15°C -15°C
En büyük sürekli uygulama ve tesisat sıcaklığı Maximum continuous application and installation temperature	+60°C +60°C
Bükülmeye karşı dayanıklılık Flexural Strength	Rijit Rigid
Dış etkenlere karşı dayanıklılık Resistance to external impacts	Katı yabancı cisimlerin girişine karşı korumalı Protected against ingress of solid foreign materials
Alev yayılmasına karşı dayanıklılık Resistance to flame propagation	Alev yaymayan borular Nonflammable

H.FREE ALEV YAYAN DÜZ ELEKTRİK TESİSAT BORULARI H.FREE FLAME-PROPAGATING PLAIN ELECTRICAL INSTALLATION PIPE

Boru tipi Type of the Pipe	Metalik olmayan Nonmetallic
Bağlantı metodu Connection method	Diş çekilmemiş Non-threaded
Sıkıştırmaya karşı dayanıklılık Compressive Strength	SİBOR SERİSİ Çok Hafif (125 N) Hafif (320 N) MEKS SERİSİ Hafif (320 N) Orta (750 N) Ağır (1250 N) SIBOR SERIES Very Low (125 N) Low (320 N) MEKS SERIES Low (320 N) Medium (750 N) Heavy (1250 N)
Darbeye karşı dayanıklılık Impact Resistance	Orta (2 Kg, 100 mm) -15°C'de Medium (2 Kg, 100 mm) - 15°C
En küçük sürekli uygulama ve tesisat sıcaklığı Minimum continuous application and installation temperature	-15°C -15°C
En büyük sürekli uygulama ve tesisat sıcaklığı Maximum continuous application and installation temperature	+60°C +60°C
Bükülmeye karşı dayanıklılık Flexural Strength	Esnek - kendini toparlayan Flexible-Self recovering
Dış etkenlere karşı dayanıklılık Resistance to external impacts	Katı yabancı cisimlerin girişine karşı korumalı Protected against ingress of solid foreign materials
Alev yayılmasına karşı dayanıklılık Resistance to flame propagation	Alev yayan Flammable

H.FREE ALEV YAYMAYAN DÜZ ELEKTRİK TESİSAT BORULARI H.FREE NON-FLAME-PROPAGATING PLAIN ELECTRICAL INSTALLATION PIPE

Boru tipi Type	Metalik olmayan Nonmetallic - Corrugated
Bağlantı metodu Connection type	Diş çekilmemiş Non-threaded
Sıkıştırmaya karşı dayanıklılık External load resistance	SİBOR SERİSİ Çok Hafif (125 N) Hafif (320 N) MEKS SERİSİ Hafif (320 N) Orta (750 N) Ağır (1250 N) SIBOR SERIES Very Low (125 N) Low (320 N) MEKS SERIES Low (320 N) Medium (750 N) Heavy (1250 N)
Darbeye karşı dayanıklılık Impact resistance	Orta (2 Kg, 100 mm) -15°C'de Medium (2 Kg, 100 mm) - 15°C
En küçük sürekli uygulama ve tesisat sıcaklığı Starting and installation temperature minimum	-15°C -15°C
En büyük sürekli uygulama ve tesisat sıcaklığı Starting and installation temperature maximum	+60°C +60°C
Bükülmeye karşı dayanıklılık Resistance for stiffness	Esnek - kendini toparlayan Flexible-Self recovering
Dış etkenlere karşı dayanıklılık Resistance to external materials	Katı yabancı cisimlerin girişine karşı korumalı Protected against ingress of solid foreign materials
Alev yayılmasına karşı dayanıklılık Resistance to fire	Alev yaymayan Nonflammable

ÇELİK SİRİRAL EKO / MEKS STEEL SPIRALS EKO / MEKS

Boru tipi Type of the Pipe	Metalik - Oluklu Metallic - Corrugated
Bağlantı metodu Connection method	Diş çekilmemiş Non-threaded
Sıkıştırmaya karşı dayanıklılık Compressive Strength	Hafif (320 N) Low (320 N)
Darbeye karşı dayanıklılık Impact Resistance	Hafif (1kg, 100 mm) Low (1 kg, 100 mm)
En küçük sürekli uygulama ve tesisat sıcaklığı Minimum continuous application and installation temperature	-15°C -15°C
En büyük sürekli uygulama ve tesisat sıcaklığı Maximum continuous application and installation temperature	+60 +60
Bükülmeye karşı dayanıklılık Flexural Strength	Esnek Flexible
Diş etkenlere karşı dayanıklılık Resistance to external impacts	Katı yabancı cisimlerin girişine karşı korumalı Protected against ingress of solid foreign materials
Alev yayılmasına karşı dayanıklılık Resistance to flame propagation	Alev yaymayan Non-flame-propagating

İZOLELİ ÇELİK SİRİRAL EKO / MEKS INSULATED STEEL SPIRALS EKO / MEKS

Boru tipi Type of the Pipe	Kompozit - Oluklu Composite - Corrugated
Bağlantı metodu Connection method	Diş çekilmemiş Non-threaded
Sıkıştırmaya karşı dayanıklılık Compressive Strength	Hafif (320 N) Low (320 N)
Darbeye karşı dayanıklılık Impact Resistance	Hafif (1kg, 100 mm) Low (1 kg, 100 mm)
En küçük sürekli uygulama ve tesisat sıcaklığı Minimum continuous application and installation temperature	-15°C -15°C
En büyük sürekli uygulama ve tesisat sıcaklığı Maximum continuous application and installation temperature	+60 +60
Bükülmeye karşı dayanıklılık Flexural Strength	Esnek Flexible
Diş etkenlere karşı dayanıklılık Resistance to external impacts	Katı yabancı cisimlerin girişine karşı korumalı Protected against ingress of solid foreign materials
Alev yayılmasına karşı dayanıklılık Resistance to flame propagation	Alev yaymayan Non-flame-propagating

PVC ALEV YAYMAYAN SİRİRAL PVC SPIRALS FLAME - PROPAGATING

Boru tipi Type of the Pipe	Metalik olmayan - Oluklu Non-Metallic - Corrugated
Bağlantı metodu Connection method	Diş çekilmemiş Non-threaded
Sıkıştırmaya karşı dayanıklılık Compressive Strength	Hafif (320 N) Orta (750 N) Low (320 N) Medium (750 N)
Darbeye karşı dayanıklılık Impact Resistance	Orta (2 kg / 100 mm) Medium (2 kg / 100 mm)
En küçük sürekli uygulama ve tesisat sıcaklığı Minimum continuous application and installation temperature	-15°C -15°C
En büyük sürekli uygulama ve tesisat sıcaklığı Maximum continuous application and installation temperature	+60 +60
Bükülmeye karşı dayanıklılık Flexural Strength	Esnek Flexible
Diş etkenlere karşı dayanıklılık Resistance to external impacts	Katı yabancı cisimlerin girişine karşı korumalı Protected against ingress of solid foreign materials
Alev yayılmasına karşı dayanıklılık Resistance to flame propagation	Alev yaymayan Non-flame-propagating

ÇELİK SİRALLER

STEEL SPIRALS

	Kod Code	İç Çap Inner Diameter	Dış Çap Outer Diameter	Kod Code	İç Çap Inner Diameter	Dış Çap Outer Diameter
EKO SERİSİ ÇELİK SİRALLER ECO SERIES STEEL SPIRALS				ÇELİK SİRALLER STEEL SPIRALS		
	001 054 150009 00 66	9 mm	12,10 mm	 001 054 120009 00 66	9 mm	12,10 mm
	001 054 150011 00 66	11 mm	14,10 mm	 001 054 120011 00 66	11 mm	14,10 mm
	001 054 150014 00 66	14 mm	17,10 mm	 001 054 120014 00 66	14 mm	17,10 mm
	001 054 150016 00 66	16 mm	19,10 mm	 001 054 120016 00 66	16 mm	19,10 mm
	001 054 150018 00 66	18 mm	21,10 mm	 001 054 120018 00 66	18 mm	21,10 mm
	001 054 150021 00 66	21 mm	24,10 mm	 001 054 120026 00 66	26 mm	29,10 mm
	001 054 150026 00 66	26 mm	29,10 mm	 001 054 120029 00 66	29 mm	32,10 mm
	001 054 150029 00 66	29 mm	32,10 mm	001 054 120032 00 66	32 mm	35,10 mm
	001 054 150032 00 66	32 mm	35,10 mm	 001 054 120037 00 66	37 mm	41,10 mm
	001 054 150037 00 66	37 mm	41,10 mm	 001 054 120042 00 66	42 mm	45,10 mm
	001 054 150042 00 66	42 mm	45,10 mm	 001 054 120050 00 66	50 mm	53,10 mm
	001 054 150050 00 66	50 mm	53,10 mm	001 054 120063 00 66	63 mm	66,10 mm



EKO SERİSİ ÇELİK SİRALLER İÇTEN TELLİ

ECO SERIES STEEL SPIRALS WITH INTERNAL WIRE

ÇELİK SİRALLER İÇTEN TELLİ

STEEL SPIRALS WITH INTERNAL WIRE

	001 054 221009 00 66	9 mm	12,10 mm	001 054 121009 00 66	9 mm	12,10 mm
	001 054 221011 00 66	11 mm	14,10 mm	001 054 121011 00 66	11 mm	14,10 mm
	001 054 221014 00 66	14 mm	17,10 mm	001 054 121014 00 66	14 mm	17,10 mm
	001 054 221016 00 66	16 mm	19,10 mm	001 054 121016 00 66	16 mm	19,10 mm
	001 054 221018 00 66	18 mm	21,10 mm	001 054 121018 00 66	18 mm	21,10 mm
	001 054 221021 00 66	21 mm	24,10 mm	001 054 121026 00 66	26 mm	29,10 mm
	001 054 221026 00 66	26 mm	29,10 mm	001 054 121029 00 66	29 mm	32,10 mm
	001 054 221029 00 66	29 mm	32,10 mm	001 054 101032 00 66	32 mm	35,10 mm
	001 054 201032 00 66	32 mm	35,10 mm	001 054 121037 00 66	37 mm	41,10 mm
	001 054 221037 00 66	37 mm	41,10 mm	001 054 121042 00 66	42 mm	45,10 mm
	001 054 221042 00 66	42 mm	45,10 mm	001 054 121050 00 66	50 mm	53,10 mm
	001 054 221050 00 66	50 mm	53,10 mm	001 054 121063 00 66	63 mm	66,10 mm



PVC İZOLELİ SPİRALLER

PVC INSULATED SPIRALS

	Kod Code	İç Çap Inner Diameter	Dış Çap Outer Diameter	Kod Code	İç Çap Inner Diameter	Dış Çap Outer Diameter
--	-------------	--------------------------	---------------------------	-------------	--------------------------	---------------------------

EKO SERİSİ İZOLELİ ÇELİK SPİRALLER

ECO SERIES INSULATED STEEL SPIRALS

İZOLELİ ÇELİK SPİRALLER

INSULATED STEEL SPIRALS

	001 054 160009 00 11	9 mm	13,20 mm	001 054 130009 00 11	9 mm	13,20 mm
	001 054 160011 00 11	11 mm	15,20 mm	001 054 130011 00 11	11 mm	15,20 mm
	001 054 160014 00 11	14 mm	18,40 mm	001 054 130014 00 11	14 mm	18,40 mm
	001 054 160016 00 11	16 mm	20,40 mm	001 054 130016 00 11	16 mm	20,40 mm
	001 054 160018 00 11	18 mm	22,40 mm	001 054 130018 00 11	18 mm	22,40 mm
	001 054 160021 00 11	21 mm	25,40 mm	001 054 130026 00 11	26 mm	30,40 mm
	001 054 160026 00 11	26 mm	30,40 mm	001 054 130029 00 11	29 mm	33,40 mm
	001 054 160029 00 11	29 mm	33,40 mm	001 054 130032 00 11	32 mm	36,40 mm
	001 054 160032 00 11	32 mm	36,40 mm	001 054 130037 00 11	37 mm	42,40 mm
	001 054 160037 00 11	37 mm	42,40 mm	001 054 130042 00 11	42 mm	46,40 mm
	001 054 160042 00 11	42 mm	46,40 mm	001 054 130050 00 11	50 mm	54,40 mm
	001 054 160050 00 11	50 mm	54,40 mm	001 054 130063 00 11	63 mm	67,20 mm

EKO SERİSİ İZOLELİ ÇELİK SPİRALLER İÇTEN TELLİ

ECO SERIES INSULATED STEEL SPIRALS WITH INTERNAL WIRE

İZOLELİ ÇELİK SPİRALLER İÇTEN TELLİ

INSULATED STEEL SPIRALS WITH INTERNAL WIRE

	001 054 231009 00 11	9 mm	13,20 mm	001 054 140009 00 11	9 mm	13,20 mm
	001 054 231011 00 11	11 mm	15,20 mm	001 054 140011 00 11	11 mm	15,20 mm
	001 054 231014 00 11	14 mm	18,40 mm	001 054 140014 00 11	14 mm	18,40 mm
	001 054 231016 00 11	16 mm	20,40 mm	001 054 140016 00 11	16 mm	20,40 mm
	001 054 131018 00 11	18 mm	22,40 mm	001 054 140018 00 11	18 mm	22,40 mm
	001 054 131021 00 11	21 mm	25,40 mm	001 054 140026 00 11	26 mm	30,40 mm
	001 054 131026 00 11	26 mm	30,40 mm	001 054 140029 00 11	29 mm	33,40 mm
	001 054 131029 00 11	29 mm	33,40 mm	001 054 140032 00 11	32 mm	36,40 mm
	001 054 131032 00 11	32 mm	36,40 mm	001 054 140037 00 11	37 mm	42,40 mm
	001 054 131037 00 11	37 mm	42,40 mm	001 054 140042 00 11	42 mm	46,40 mm
	001 054 131042 00 11	42 mm	46,40 mm	001 054 140050 00 11	50 mm	54,40 mm
	001 054 131050 00 11	50 mm	54,40 mm	001 054 100063 00 11	63 mm	67,20 mm

PVC SİRALLER

PVC SPIRALS

	Kod Code	İç Çap Inner Diameter	Dış Çap Outer Diameter
--	-------------	--------------------------	---------------------------

PVC ALEV YAYMAYAN SİRALLER (FLEXI MEKS) 750 N

PVC NON-FLAME-PROPAGATING SPIRALS (FLEXI MEKS) 750 N

	001 020 000016 00 17	11,20 mm	15,85 mm
	001 020 000020 00 17	14,40 mm	19,85 mm
	001 020 000025 00 17	18,10 mm	24,80 mm
	001 020 000032 00 17	24,70 mm	31,80 mm

PVC ALEV YAYMAYAN KLAVUZ TELLİ SİRALLER (FLEXI MEKS) 750 N

PVC NON-FLAME-PROPAGATING SPIRALS WITH GUIDE WIRE (FLEXI MEKS) 750 N

	001 020 100016 00 17	11,20 mm	15,85 mm
	001 020 100020 00 17	14,40 mm	19,85 mm
	001 020 100025 00 17	18,10 mm	24,80 mm
	001 020 100032 00 17	24,70 mm	31,80 mm

PVC ALEV YAYMAYAN SİRALLER (FLEXI MEKS) 320 N

PVC NON-FLAME-PROPAGATING SPIRALS (FLEXI MEKS) 320 N

	001 020 010016 00 17	11,40 mm	15,85 mm
	001 020 010020 00 17	14,50 mm	19,85 mm
	001 020 010025 00 17	18,70 mm	24,80 mm
	001 020 010032 00 17	24,90 mm	31,80 mm

PVC ALEV YAYMAYAN KLAVUZ TELLİ SİRALLER (FLEXI MEKS) 320 N

PVC NON-FLAME-PROPAGATING SPIRALS WITH GUIDE WIRE (FLEXI MEKS) 320 N

	001 020 120016 00 17	11,40 mm	15,85 mm
	001 020 120020 00 17	14,50 mm	19,85 mm
	001 020 120025 00 17	18,70 mm	24,80 mm
	001 020 120032 00 17	24,90 mm	31,80 mm

HALOJEN FREE SPİRALLER 320 N

HALOGEN-FREE SPIRALS 320 N

	Kod Code	İç Çap Inner Diameter	Dış Çap Outer Diameter
--	-------------	--------------------------	---------------------------

HALOJEN FREE SPİRAL ALEV YAYAN 320 N

HALOGEN FREE SPIRALS (FLAME-PROPAGATING) 320 N

  	001 020 140016 00 12	11,20 mm	15,70 mm
	001 020 140020 00 12	14,40 mm	19,85 mm
	001 020 140025 00 12	19,10 mm	24,70 mm
	001 020 140032 00 12	24,85 mm	31,60 mm
	001 020 140040 00 12		
	001 020 140050 00 12		

HALOJEN FREE SPİRAL ALEV YAYAN KILAVUZ TELLİ 320 N

HALOGEN FREE SPIRALS (FLAME-PROPAGATING) WITH GUIDE WIRE 320 N

  	001 020 141016 00 12	11,20 mm	15,70 mm
	001 020 141020 00 12	14,40 mm	19,85 mm
	001 020 141025 00 12	19,10 mm	24,70 mm
	001 020 141032 00 12	24,85 mm	31,60 mm
	001 020 141040 00 12		
	001 020 141050 00 12		



HALOJEN FREE SPİRAL ALEV YAYMAYAN 320 N

HALOGEN FREE SPIRALS (NON-FLAME-PROPAGATING) 320 N

  	001 020 150016 00 17	11,20 mm	15,70 mm
	001 020 150020 00 17	14,40 mm	19,85 mm
	001 020 150025 00 17	19,10 mm	24,70 mm
	001 020 150032 00 17	24,85 mm	31,60 mm
	001 020 150040 00 17		
	001 020 150050 00 17		

HALOJEN FREE SPİRAL ALEV YAYMAYAN KILAVUZ TELLİ 320 N

HALOGEN FREE SPIRALS (NON-FLAME-PROPAGATING) WITH GUIDE WIRE 320 N

  	001 020 151016 00 17	11,20 mm	15,70 mm
	001 020 151020 00 17	14,40 mm	19,85 mm
	001 020 151025 00 17	19,10 mm	24,70 mm
	001 020 151032 00 17	24,85 mm	31,60 mm
	001 020 151040 00 17		
	001 020 151050 00 17		

HALOJEN FREE SPİRALLER 750 N

HALOGEN-FREE SPIRALS 750 N

	Kod Code	İç Çap Inner Diameter	Dış Çap Outer Diameter
--	-------------	--------------------------	---------------------------

HALOJEN FREE SPİRAL ALEV YAYAN 750 N

HALOGEN FREE SPIRALS (FLAME-PROPAGATING) 750 N

  	001 020 740020 00 12	14,40 mm	19,85 mm
	001 020 740025 00 12	18,70 mm	24,70 mm
	001 020 740032 00 12	24,20 mm	31,60 mm

HALOJEN FREE SPİRAL ALEV YAYAN KILAVUZ TELLİ 750 N

HALOGEN FREE SPIRALS (FLAME-PROPAGATING) WITH GUIDE WIRE 750 N

  	001 020 741020 00 12	14,40 mm	19,85 mm
	001 020 741025 00 12	18,70 mm	24,70 mm
	001 020 741032 00 12	24,20 mm	31,60 mm

HALOJEN FREE SPİRAL ALEV YAYMAYAN 750 N

HALOGEN FREE SPIRALS (NON-FLAME-PROPAGATING) 750 N

  	001 020 750020 00 17	14,40 mm	19,85 mm
	001 020 750025 00 17	18,70 mm	24,70 mm
	001 020 750032 00 17	24,20 mm	31,60 mm

HALOJEN FREE SPİRAL ALEV YAYMAYAN KILAVUZ TELLİ 750 N

HALOGEN FREE SPIRALS (NON-FLAME-PROPAGATING) WITH GUIDE WIRE 750 N

  	001 020 751020 00 17	14,40 mm	19,85 mm
	001 020 751025 00 17	18,70 mm	24,70 mm
	001 020 751032 00 17	24,20 mm	31,60 mm

HALOJEN FREE SİRALLER 1250 N

HALOGEN-FREE SPIRALS 1250 N

	Kod Code	İç Çap Inner Diameter	Dış Çap Outer Diameter
--	-------------	--------------------------	---------------------------

HALOJEN FREE SİRAL ALEV YAYAN 1250 N

HALOGEN FREE SPIRALS (FLAME-PROPAGATING) 1250 N

  	001 020 240020 00 12	14,00 mm	19,85 mm
	001 020 240025 00 12	18,40 mm	24,70 mm
	001 020 240032 00 12	24,00 mm	31,60 mm

HALOJEN FREE SİRAL ALEV YAYAN KILAVUZ TELLİ 1250 N

HALOGEN FREE SPIRALS (FLAME-PROPAGATING) WITH GUIDE WIRE 1250 N

  	001 020 241020 00 12	14,00 mm	19,85 mm
	001 020 241025 00 12	18,40 mm	24,70 mm
	001 020 241032 00 12	24,00 mm	31,60 mm

HALOJEN FREE SİRAL ALEV YAYMAYAN 1250 N

HALOGEN FREE SPIRALS (NON-FLAME-PROPAGATING) 1250 N

  	001 020 250020 00 17	14,00 mm	19,85 mm
	001 020 250025 00 17	18,40 mm	24,70 mm
	001 020 250032 00 17	24,00 mm	31,60 mm

HALOJEN FREE SİRAL ALEV YAYMAYAN KILAVUZ TELLİ 1250 N

HALOGEN FREE SPIRALS (NON-FLAME-PROPAGATING) WITH GUIDE WIRE 1250 N

  	001 020 251020 00 17	14,00 mm	19,85 mm
	001 020 251025 00 17	18,40 mm	24,70 mm
	001 020 251032 00 17	24,00 mm	31,60 mm

PLASTİK SİRİRAL BORULAR

PLASTIC SPIRAL PIPES

Kod Code	İç Çap Inner Diameter	Dış Çap Outer Diameter
-------------	--------------------------	---------------------------

PLASTİK SİRİRALER

PLASTIC SPIRALS

	001 020 400014 00 11	15,25 mm	18,75 mm
	001 020 400016 00 11	15,70 mm	19,00 mm
	001 020 400018 00 11	19,60 mm	24,03 mm
	001 020 400020 00 11	19,60 mm	24,03 mm
	001 020 400026 00 11	26,15 mm	30,75 mm
	001 020 400032 00 11	29,10 mm	34,30 mm
	001 020 400040 00 11	36,20 mm	42,20 mm
	001 020 400050 00 11	48,50 mm	54,50 mm

PLASTİK SİRİRALER KLAVUZ TELLİ

PLASTIC SPIRAL WITH GUIDE WIRE

	001 020 410014 00 11	15,25 mm	18,75 mm
	001 020 410016 00 11	15,70 mm	19,00 mm
	001 020 410018 00 11	19,60 mm	24,03 mm
	001 020 410020 00 11	19,60 mm	24,03 mm
	001 020 410026 00 11	26,15 mm	30,75 mm
	001 020 410032 00 11	29,10 mm	34,30 mm
	001 020 410040 00 11	36,20 mm	42,20 mm
	001 020 410050 00 11	48,50 mm	54,50 mm

POLYAMİD SİRİRALER

POLYAMIDE SPIRALS

	001 020 170007 00 17	7,00 mm	10,10 mm
	001 020 170009 00 17	8,40 mm	12,05 mm
	001 020 170010 00 17	10,20 mm	13,10 mm
	001 020 170012 00 17	12,30 mm	15,90 mm
	001 020 170014 00 17	14,10 mm	18,35 mm
	001 020 170017 00 17	17,00 mm	21,45 mm
	001 020 170019 00 17	19,00 mm	24,25 mm
	001 020 170023 00 17	23,25 mm	28,50 mm
	001 020 170026 00 17	26,20 mm	31,30 mm
	001 020 170029 00 17	29,10 mm	34,30 mm
	001 020 170036 00 17	36,20 mm	42,20 mm
	001 020 170048 00 17	48,50 mm	54,50 mm

POLİPROPİLEN SİRİRALER

POLYPROPYLENE SPIRALS

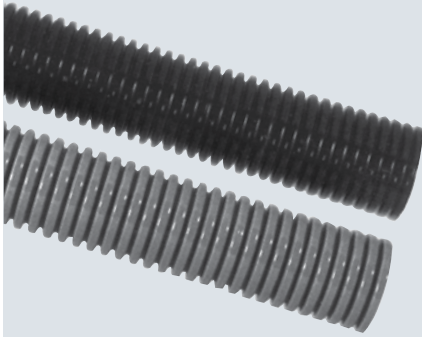
	001 020 160007 00 17	7,00 mm	10,10 mm
	001 020 160009 00 17	8,40 mm	12,05 mm
	001 020 160010 00 17	10,20 mm	13,10 mm
	001 020 160012 00 17	12,30 mm	15,90 mm
	001 020 160014 00 17	14,10 mm	18,35 mm
	001 020 160017 00 17	17,00 mm	21,45 mm
	001 020 160019 00 17	19,00 mm	24,25 mm
	001 020 160023 00 17	23,25 mm	28,50 mm
	001 020 160026 00 17	26,20 mm	31,30 mm
	001 020 160029 00 17	29,10 mm	34,30 mm
	001 020 160036 00 17	36,20 mm	42,20 mm
	001 020 160048 00 17	48,50 mm	54,50 mm

PLASTİK SPİRAL BORU AKSESUARLARI

PLASTIC SPIRAL PIPES ACCESSORIES

	Kod Code	İç Çap Inner Diameter	Dış Çap Outer Diameter
KABLO TOPLAMA SPİRALİ CABLE ORGANIZER SPIRAL			
	888 020 900001	10 mm	
	888 020 900003	16 mm	
	888 020 900004	16 mm	
	888 020 900006	22 mm	
	888 020 900007	22 mm	
	888 020 900009	28 mm	
	888 020 900010	28 mm	
	888 020 900011	34 mm	

SPİRAL BİRLEŞTİRİCİ

SPIRAL COUPLER

	001 020 990016 00 17	16 mm	
	001 020 990020 00 17	20 mm	
	001 020 990025 00 17	25 mm	
	001 020 990032 00 17	32 mm	

HELEZON PANO SPİRALİ

HELICOID PANEL SPIRAL

	Ürün Adı Product Name	Boy Size	Adet Quantity
	001 020 500001 05 00	No:1	50 cm
	001 020 500002 05 00	No:2	50 cm
	001 020 500003 05 00	No:3	50 cm
	001 020 500004 05 00	No:4	50 cm
	001 020 500005 05 00	No:5	50 cm

HELEZON PANO SPİRALİ (RULO)

HELICOID PANEL SPIRAL (ROLL)

	Ürün Adı Product Name	Adet Boyu Quantity Size
	001 020 600001 00 00	No:1
	001 020 600002 00 00	No:2
	001 020 600003 00 00	No:3
	001 020 600004 00 00	No:4
	001 020 600005 00 00	No:5

HAZIR SPİRALLİ KABLolar

PREWIRED ELECTRO CONDUITS

	Kod Code	Kablo Kesiti mm ² Cable Dimension mm ²	Spiral Özellik Spiral Specification	Spiral Çap (mm) Spiral Diameter (mm)
--	-------------	-----------------------------------------------------------------	----------------------------------------	-----------------------------------------

SPİRALLİ ENERJİ KABLolar

SPIRALS ENERGY CABLES

H07V-U (NYA) KABLolar

H07V-U (NYA) ENERGY CABLES

	122 050 215014	2x1.5	HF-PE	14
	122 050 315014	3x1.5	HF-PE	14
	122 050 415016	4x1.5	HF-PE	16
	122 050 225014	2x2.5	HF-PE	14
	122 050 325016	3x2.5	HF-PE	16
	122 050 425020	4x2.5	HF-PE	20

H07V-U (NYA) KABLolar HALOGEN FREE

H07V-U (NYA) ENERGY CABLES HALOGEN FREE

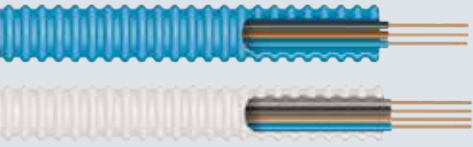

	122 051 215014	2x1.5	HF-PE	14
	122 051 315014	3x1.5	HF-PE	14
	122 051 415016	4x1.5	HF-PE	16
	122 051 225014	2x2.5	HF-PE	14
	122 051 325016	3x2.5	HF-PE	16
	122 051 425020	4x2.5	HF-PE	20

SPİRALLİ ZAYIF AKIM KABLolar

SPIRALS LOW CURRENT CABLES

DATA KABLolar

DATA CABLES

	122 052 100516	U / UTP CAT5e	HF-PE	16
	122 052 100616	U / UTP CAT6e	HF-PE	16

KOAKSİYEL KABLolar

TV CABLES

	122 052 200214	RG 59/U2 (cu/AL)	HF-PE	14
	122 052 200416	RG 6/U4 (cu/AL)	HF-PE	16
	122 052 200616	RG 6/U6 (cu/AL)	HF-PE	16

CCTV KAMERA KABLolar

CCTV CAMERA CABLES

	122 052 301214	CCTV 1+2 (2x0.22mm ²)	HF-PE	14
	122 052 301416	CCTV 1+4 (2x2x0.22mm ²)	HF-PE	16

JY (st) Y YANGIN İHBAR KABLolar

JY (st) Y FIRE SYSTEM CABLES

	122 052 401216	JY(st)Y 1x2x0.80+40 mm ²	HF-PE	16
	122 052 402216	JY(st)Y 2x2x0.80+40 mm ²	HF-PE	16
	122 052 404216	JY(st)Y 4x2x0.80+40 mm ²	HF-PE	20

DİYAFON KABLolar

INTERCOM CABLES

	122 052 502216	DT-8 8x0.22 mm ²	HF-PE	16
-------------------------------------------------------------------------------------	----------------	-----------------------------	-------	----

HAZIR SİRALLİ KABLOLAR

PREWIRED ELECTRO CONDUITS

Kod Code	Kablo Kesiti mm ² Cable Dimension mm ²	Spiral Özellik Spiral Specification	Spiral Çap (mm) Spiral Diameter (mm)
-------------	-----------------------------------------------------------------	----------------------------------------	-----------------------------------------

SİRALLİ ZAYIF AKIM KABLOLARI HALOGEN FREE

SPIRALS LOW CURRENT CABLES HALOGEN FREE



(LSZH) DATA KABLOLARI HALOGEN FREE

(LSZH) DATA CABLES HALOGEN FREE

122 053 100516	U / UTP CAT5e (4x2x24 AWG)	HF-PE	16
122 053 100616	U / UTP CAT6 (4x2x23 AWG)	HF-PE	16



(PHY-HF) KOAKSİYEL KABLOLAR HALOGEN FREE

(PHY-HF) TV CABLES HALOGEN FREE

122 053 200416	RG 59/U2 (cu/AL)	HF-PE	16
122 052 200616	RG 6/U4 (cu/AL)	HF-PE	16

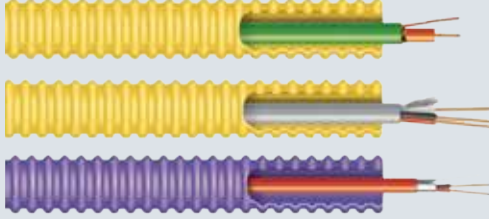

CCTV KAMERA KABLOLARI HALOGEN FREE

CCTV CAMERA CABLES HALOGEN FREE

122 052 301214	CCTV 1+2 (2x0.22mm ²)	HF-PE	14
122 052 301416	CCTV 1+4 (2x2x0.22mm ²)	HF-PE	16

JY (st) Y YANGIN İHBAR KABLOLARI HALOGEN FREE

JY (st) Y FIRE SYSTEM HALOGEN FREE



122 052 401216	JY(st)Y 1x2x0.80+40 mm ²	HF-PE	16
122 052 402216	JY(st)Y 2x2x0.80+40 mm ²	HF-PE	16
122 052 404216	JY(st)Y 4x2x0.80+40 mm ²	HF-PE	20

LIHH DİYAFON KABLOLARI HALOGEN FREE

(LIHH) INTERCOM CABLES HALOGEN FREE



122 052 502216	DT-8 8x0.22 mm ²	HF-PE	16
----------------	-----------------------------	-------	----

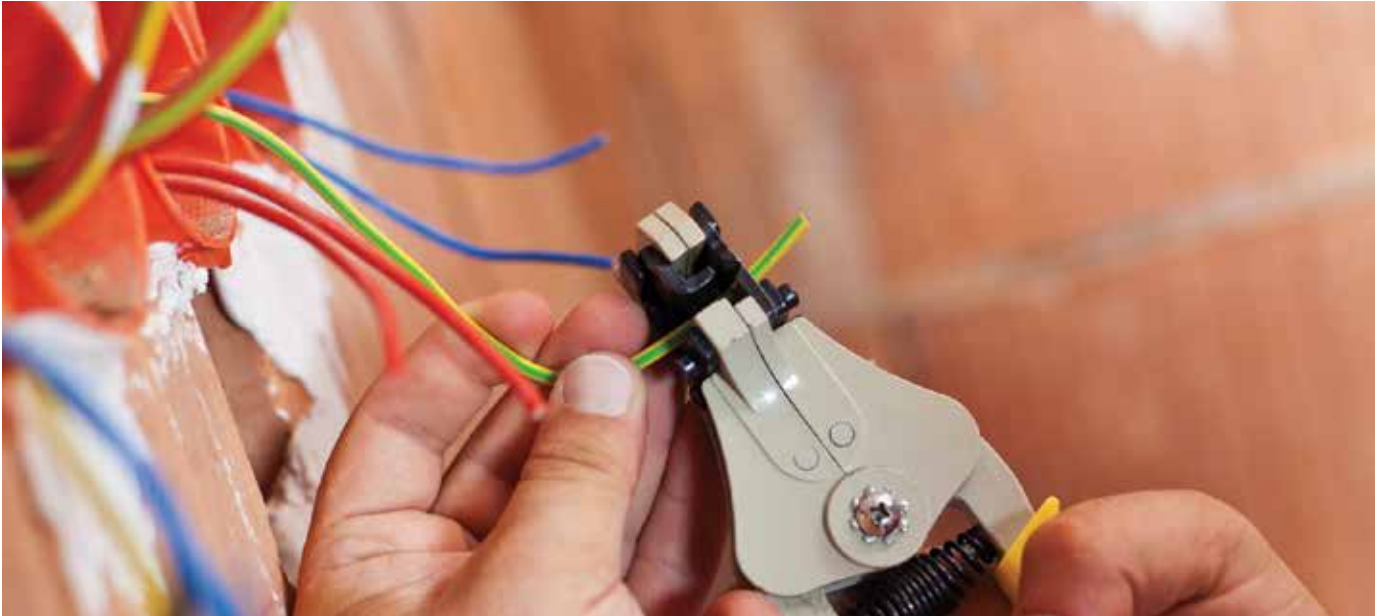

HALOJEN FREE RİJİT ALEV YAYMAYAN BORULAR

HALOGEN FREE NON-FLAME-PROPAGATING RIJIT PIPES

	Kod Code	İç Çap Inner Diameter	Dış Çap (+0,-0.3) Outer Diameter
--	-------------	--------------------------	-------------------------------------





HALOJEN FREE ALEV YAYMAYAN BORULAR - 320 N

HALOGEN FREE NON-FLAME-PROPAGATING PIPES - 320 N

    	001 045 500016 30 17	12.4 mm	16 mm
	001 045 500020 30 17	16.6 mm	20 mm
	001 045 500025 30 17	20.6 mm	25 mm
	001 045 500032 30 17	28.8 mm	32 mm
	001 045 500040 30 17	36.7 mm	40 mm
	001 045 500050 30 17	42.9 mm	50 mm





HALOJEN FREE ALEV YAYMAYAN BORULAR - 750 N

HALOGEN FREE NON-FLAME-PROPAGATING PIPES - 750 N

    	001 045 510016 30 17	12.4 mm	16 mm
	001 045 510020 30 17	16.0 mm	20 mm
	001 045 510025 30 17	20.6 mm	25 mm
	001 045 510032 30 17	26.8 mm	32 mm
	001 045 510040 30 17	33.9 mm	40 mm
	001 045 510050 30 17	42.9 mm	50 mm

HALOJEN FREE ALEV YAYMAYAN BORULAR - 1250 N

HALOGEN FREE NON-FLAME-PROPAGATING PIPES - 1250 N

    	001 045 520016 30 17	12.1 mm	16 mm
	001 045 520020 30 17	15.2 mm	20 mm
	001 045 520025 30 17	20.0 mm	25 mm
	001 045 520032 30 17	25.9 mm	32 mm
	001 045 520040 30 17	32.3 mm	40 mm
	001 045 520050 30 17	42.0 mm	50 mm



PVC ALEV YAYMAYAN BORULAR

PVC NON-FLAME-PROPAGATING PIPES

	Kod Code	İç Çap Inner Diameter	Dış Çap (+0,-0.3) Outer Diameter
--	-------------	--------------------------	-------------------------------------

PVC KENDİNDEN MUFLU ALEV YAYMAYAN BORULAR 750 N

PVC SELF FITTING NON FLAME PROPAGATING PIPES 750 N

		001 045 110014 30 17	11,80 mm	14 mm
	CE	001 045 110016 30 17	12,80 mm	15,90 mm
		001 045 110018 30 17	15,50 mm	18 mm
	CE	001 045 110020 30 17	16,70 mm	19,90 mm
	CE	001 045 110025 30 17	21,90 mm	24,80 mm
	CE	001 045 110032 30 17	29 mm	31,89mm
		001 045 110040 30 17	37,40 mm	39,89 mm

DİRSEKLER

BRACKETS

	CE	001 051 010014 00 17	14 mm	18 mm
	CE	001 051 010016 00 17	16 mm	20 mm
	CE	001 051 010018 00 17	18 mm	22 mm
	CE	001 051 010020 00 17	20 mm	24 mm
	CE	001 051 010025 00 17	25 mm	29 mm
	CE	001 051 010032 00 17	32 mm	36 mm

MUFLAR

COUPLER FITTING

	CE	001 051 030014 00 17	14 mm	18 mm
	CE	001 051 030016 00 17	16 mm	20 mm
	CE	001 051 030018 00 17	18 mm	22 mm
	CE	001 051 030020 00 17	20 mm	24 mm
	CE	001 051 030025 00 17	25 mm	29 mm
	CE	001 051 030032 00 17	32 mm	36 mm

PVC ALEV YAYMAYAN BORULAR 750 N

PVC NON-FLAME-PROPAGATING PIPES 750 N

		001 045 120014 30 17	11,80 mm	14 mm
	CE	001 045 120016 30 17	12,80 mm	16 mm
		001 045 120018 30 17	16,50 mm	18 mm
	CE	001 045 120020 30 17	16,70 mm	20 mm
	CE	001 045 120025 30 17	21,90 mm	25 mm
	CE	001 045 120032 30 17	29 mm	32 mm
	CE	001 045 120040 30 17	37,40 mm	40 mm



SİBOR SERİSİ HALOJEN FREE TURUNCU BORULAR

SIBOR SERIES HALOGEN FREE ORANGE PIPES

	Kod Code	İç Çap Inner Diameter	Dış Çap (+0,-0.3) Outer Diameter
--	-------------	--------------------------	-------------------------------------

SİBOR SERİSİ 6 ATÜ ALEV YAYAN 125 N

SIBOR SERIES 6 ATU FLAME-PROPAGATING 125 N

 	001 165 706014 00 12	10.4 mm	14 mm
	001 165 706016 00 12	12.4 mm	16 mm
	001 165 706018 00 12	14.6 mm	18 mm
	001 165 706020 00 12	16.6 mm	20 mm
	001 165 706025 00 12	20.6 mm	25 mm
	001 165 706032 00 12	28.8 mm	32 mm
	001 165 706037 00 12	33.6 mm	37 mm
	001 165 706040 00 12	36.7 mm	40 mm
	001 165 706050 00 12	42.9 mm	50 mm

SİBOR SERİSİ 6 ATÜ ALEV YAYMAYAN 125 N

SIBOR SERIES 6 ATU NON-FLAME-PROPAGATING 125 N

  	001 165 206014 00 12	10.4 mm	14 mm
	001 165 206016 00 12	12.4 mm	16 mm
	001 165 206018 00 12	14.6 mm	18 mm
	001 165 206020 00 12	16.6 mm	20 mm
	001 165 206025 00 12	20.6 mm	25 mm
	001 165 206032 00 12	28.8 mm	32 mm
	001 165 206037 00 12	33.6 mm	37 mm
	001 165 206040 00 12	36.7 mm	40 mm
	001 165 206050 00 12	42.9 mm	50 mm



SİBOR SERİSİ 10 ATÜ ALEV YAYAN 320 N

SIBOR SERIES 10 ATU FLAME-PROPAGATING 320 N

 	001 165 710014 00 12	9.4 mm	14 mm
	001 165 710016 00 12	12.4 mm	16 mm
	001 165 710018 00 12	13.6 mm	18 mm
	001 165 710020 00 12	16.0 mm	20 mm
	001 165 710025 00 12	20.6 mm	25 mm
	001 165 710032 00 12	26.8 mm	32 mm
	001 165 710037 00 12	33.6 mm	37 mm
	001 165 710040 00 12	33.9 mm	40 mm
	001 165 710050 00 12	42.9 mm	50 mm



















SİBOR SERİSİ 10 ATÜ ALEV YAYMAYAN 320 N

SIBOR SERIES 10 ATU NON-FLAME-PROPAGATING 320 N

  	001 165 210014 00 12	9.4 mm	14 mm
	001 165 210016 00 12	12.4 mm	16 mm
	001 165 210018 00 12	13.6 mm	18 mm
	001 165 210020 00 12	16.0 mm	20 mm
	001 165 210025 00 12	20.6 mm	25 mm
	001 165 210032 00 12	26.8 mm	32 mm
	001 165 210037 00 12	33.6 mm	37 mm
	001 165 210040 00 12	33.9 mm	40 mm
	001 165 210050 00 12	42.9 mm	50 mm

POLİETİLEN HALOJEN FREE BORULAR

POLYETHYLENE HALOGEN-FREE PIPES

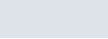
	Kod Code	İç Çap Inner Diameter	Dış Çap Outer Diameter	
6 ATÜ ALEV YAYAN - 320 N 6 ATU FLAME-PROPAGATING - 320 N				
  	001 165 506014 00 12	11,25 mm	14,50 mm	
	 001 165 506016 00 12	12,65 mm	15,85 mm	
	001 165 506018 00 12	14,60 mm	18 mm	
	 001 165 506020 00 12	16,45 mm	19,85 mm	
	 001 165 506025 00 12	20,80 mm	24,80 mm	
	 001 165 506032 00 12	26,80 mm	31,80 mm	
	001 165 506037 00 12	30,80 mm	36,80 mm	
	 001 165 506040 00 12	33,90 mm	39,80 mm	
	 001 165 506050 00 12	42,90 mm	49,75 mm	
	 001 165 506063 00 12	55,30 mm	62,70 mm	
	 001 165 506075 00 12	66 mm	74,70 mm	
	001 165 506090 00 12	81,80 mm	90,85 mm	
	10 ATÜ ALEV YAYAN - 750 N 10 ATU FLAME-PROPAGATING - 750 N			
	  	001 165 510014 00 12	10,70 mm	14,45 mm
 001 165 510016 00 12		12 mm	15,85 mm	
001 165 510018 00 12		14,60 mm	18 mm	
 001 165 510020 00 12		15,15 mm	19,85 mm	
 001 165 510025 00 12		19,80 mm	24,80 mm	
 001 165 510032 00 12		25,25 mm	31,80 mm	
001 165 510037 00 12		29,50 mm	36,80 mm	
 001 165 510040 00 12		32,30 mm	39,80 mm	
 001 165 510050 00 12		42 mm	49,75 mm	
 001 165 510063 00 12		52,90 mm	62,70 mm	
 001 165 510075 00 12		64,30 mm	74,70 mm	
001 165 510090 00 12		78,80 mm	90,85 mm	
001 165 510100 00 12		89,90 mm	100,95 mm	
001 165 510110 00 12		95 mm	111 mm	

POLİETİLEN HALOJEN FREE BORULAR







POLYETHYLENE HALOGEN-FREE PIPES

	Kod Code	İç Çap Inner Diameter	Dış Çap Outer Diameter
6 ATÜ ALEV YAYMAYAN - 320 N 6 ATU NON-FLAME-PROPAGATING - 320 N			
    	001 165 106014 00 12	11,25 mm	14,50 mm
	  001 165 106016 00 12	12,65 mm	15,85 mm
	001 165 106018 00 12	14,60 mm	18 mm
	  001 165 106020 00 12	16,45 mm	19,85 mm
	  001 165 106025 00 12	20,80 mm	24,80 mm
	  001 165 106032 00 12	26,80 mm	31,80 mm
	001 165 106037 00 12	30,80 mm	36,80 mm
	  001 165 106040 00 12	33,90 mm	39,80 mm
	  001 165 106050 00 12	42,90 mm	49,75 mm
	  001 165 106063 00 12	55,30 mm	62,70 mm
	  001 165 106075 00 12	66 mm	74,70 mm
	001 165 106090 00 12	81,80 mm	90,85 mm

10 ATÜ ALEV YAYMAYAN - 750 N 10 ATU NON-FLAME-PROPAGATING - 750 N			
    	001 165 110014 00 12	10,70 mm	14,45 mm
	  001 165 110016 00 12	12 mm	15,85 mm
	001 165 110018 00 12	14,60 mm	18 mm
	  001 165 110020 00 12	15,15 mm	19,85 mm
	  001 165 110025 00 12	19,80 mm	24,80 mm
	  001 165 110032 00 12	25,25 mm	31,80 mm
	001 165 110037 00 12	29,50 mm	36,80 mm
	  001 165 110040 00 12	32,30 mm	39,80 mm
	  001 165 110050 00 12	42 mm	49,75 mm
	  001 165 110063 00 12	52,90 mm	62,70 mm
	  001 165 110075 00 12	64,30 mm	74,70 mm
	001 165 110090 00 12	78,80 mm	90,85 mm
	001 165 110100 00 12	89,90 mm	100,95 mm
	001 165 110110 00 12	95 mm	111 mm

POLİETİLEN HALOJEN FREE BORULAR

POLYETHYLENE HALOGEN-FREE PIPES









	Kod Code	Ort. İç Çap Inner Diameter	Ort. Dış Çap Outer Diameter
ALEV YAYAN - 1250 N FLAME-PROPAGATING - 1250 N			
  	001 165 512014 00 12	9,25 mm	14,50 mm
	 001 165 512016 00 12	10,70 mm	15,85 mm
	001 165 512018 00 12	12,60 mm	18 mm
	 001 165 512020 00 12	14,50 mm	19,85 mm
	 001 165 512025 00 12	18,00 mm	24,80 mm
	 001 165 512032 00 12	25,80 mm	31,80 mm
	001 165 512037 00 12	30,80 mm	36,80 mm
	 001 165 512040 00 12	33,90 mm	39,80 mm
	 001 165 512050 00 12	43,50 mm	49,75 mm
	 001 165 512063 00 12	52,90 mm	62,70 mm
	 001 165 512075 00 12	64,30 mm	74,70 mm
	001 165 512090 00 12	79,80 mm	90,00 mm

ALEV YAYMAYAN - 1250 N NON-FLAME-PROPAGATING - 1250 N			
   	001 165 112014 00 12	9,25 mm	14,45 mm
	 001 165 112016 00 12	10,70 mm	15,85 mm
	001 165 112018 00 12	12,60 mm	18 mm
	 001 165 112020 00 12	14,50 mm	19,85 mm
	 001 165 112025 00 12	18,00 mm	24,80 mm
	 001 165 112032 00 12	25,80 mm	31,80 mm
	001 165 112037 00 12	30,80 mm	36,80 mm
	 001 165 112040 00 12	33,90 mm	39,80 mm
	 001 165 112050 00 12	43,50 mm	49,75 mm
	 001 165 112063 00 12	52,90 mm	62,70 mm
	 001 165 112075 00 12	64,30 mm	74,70 mm
	001 165 112090 00 12	79,80 mm	90,00 mm

POLİETİLEN SİYAH BORULAR

POLYETHYLENE BLACK PIPES

	Kod Code	Ort. İç Çap Inner Diameter	Ort. Dış Çap Outer Diameter
6 ATÜ 450 N 6 ATU 450 N			
	001 165 406014 00 11	11,50 mm	14,65 mm
	001 165 406016 00 11	12,75 mm	16 mm
	001 165 406018 00 11	14,70 mm	18,10 mm
	001 165 406020 00 11	16,25 mm	20 mm
	 CE 001 165 406025 00 11	20,79 mm	25 mm
	 CE 001 165 406032 00 11	26,80 mm	32 mm
	001 165 406037 00 11	30,27 mm	37 mm
	 CE 001 165 406040 00 11	33,90 mm	40 mm
	 CE 001 165 406050 00 11	42,90 mm	50 mm
	 CE 001 165 406063 00 11	55,30 mm	63 mm
	 CE 001 165 406075 00 11	66 mm	75 mm
 CE 001 165 406090 00 11	81,80 mm	90 mm	

	Kod Code	Ort. İç Çap Inner Diameter	Ort. Dış Çap Outer Diameter
10 ATÜ 750 N 10 ATU 750 N			
	001 165 410014 00 11	10,50 mm	14,65 mm
	001 165 410016 00 11	12 mm	16 mm
	001 165 410018 00 11	14,30 mm	18,10 mm
	001 165 410020 00 11	15,30 mm	20 mm
	 CE 001 165 410025 00 11	19,80 mm	25 mm
	 CE 001 165 410032 00 11	25,80 mm	32 mm
	001 165 410037 00 11	29,50 mm	37 mm
	 CE 001 165 410040 00 11	32,30 mm	40 mm
	 CE 001 165 410050 00 11	42 mm	50 mm
	 CE 001 165 410063 00 11	52,90 mm	63 mm
	 CE 001 165 410075 00 11	64,30 mm	75 mm
	 CE 001 165 410090 00 11	78,80 mm	90 mm
	001 165 410100 00 11	89,90 mm	100 mm
	 CE 001 165 410110 00 11	95 mm	110 mm

PLASTİK BORULAR

PLASTIC PIPES

	001 045 000014 30 00	14 mm Kalın Boy Boru	14 mm Thick Pipes
	001 045 000018 30 00	18 mm Kalın Boy Boru	18 mm Thick Pipes
	001 045 000026 30 00	26 mm Kalın Boy Boru	26 mm Thick Pipes
	001 045 000037 30 00	37 mm Kalın Boy Boru	37 mm Thick Pipes
	001 045 010014 00 11	14 mm Kanganal (Normal)	14 mm Coil (Normal)
	001 045 010018 00 11	18 mm Kanganal (Normal)	18 mm Coil (Normal)
	001 045 010026 00 11	26 mm Kanganal (Normal)	26 mm Coil (Normal)
	001 045 010037 00 11	37 mm Kanganal (Normal)	37 mm Coil (Normal)

KAUÇUK BORULAR

RUBBER PIPES

	001 045 020014 00 00	14 mm Kanganal (Kauçuk)	14 mm Coil (Rubber)
	001 045 020018 00 00	18 mm Kanganal (Kauçuk)	18 mm Coil (Rubber)
	001 045 020026 00 00	26 mm Kanganal (Kauçuk)	26 mm Coil (Rubber)
	001 045 020037 00 00	37 mm Kanganal (Kauçuk)	37 mm Coil (Rubber)
	001 045 030014 00 00	14 mm Kanganal (Kauçuk) (Kalın)	14 mm Coil (Rubber) (Thick)
	001 045 030018 00 00	18 mm Kanganal (Kauçuk) (Kalın)	18 mm Coil (Rubber) (Thick)

SUSTALAR VE BUAT KAPAKLARI

CABLE PULLERS AND JUNCTION BOX COVERS

	Kod Code	Açıklama Description	Ambalaj Packing	Adet Quantity	Ağırlık Weight	Hacim Volume
--	-------------	-------------------------	--------------------	------------------	-------------------	-----------------

LÜX BUAT KAPAKLARI

LUX JUNCTION BOX COVERS

	126 046 180003	Lux Buat Kapağı (Plastik Ayak) Düz Lux Junction Box Cover (Plastic Trivet) Flat	Kutu Pack	500	6 Kg	0.195
	126 046 180004	L. B. K. (Bombeli - Pls. Ayak) Demir Vidalı 1. Kalite Lux Junction Box Cover (Curved-Plastic Trivet) Iron Screw, Premium Quality	Kutu Pack	500	7.5 Kg	0.195
	126 046 180001	Lux Buat Kapağı (Bombeli-Plastik Ayak) Lux Junction Box Cover (Curved-Plastic Trivet)	Kutu Pack	500	6 Kg	0.195

PVC İZOLE KAPLI ÇELİK SUSTA

PVC INSULATION COATED STEEL CABLE PULLER

	049 019 300010	PVC İzole Kaplı Çelik Susta 10 mt PVC Insulation Coated Steel Cable Puller 10 m	Kutu Pack	-	-	-
	049 019 300015	PVC İzole Kaplı Çelik Susta 15 mt PVC Insulation Coated Steel Cable Puller 15 m	Kutu Pack	-	-	-
	049 019 300020	PVC İzole Kaplı Çelik Susta 20 mt PVC Insulation Coated Steel Cable Puller 20 m	Kutu Pack	-	-	-
	049 019 300025	PVC İzole Kaplı Çelik Susta 25 mt PVC Insulation Coated Steel Cable Puller 25 m	Kutu Pack	-	-	-

PLASTİK SUSTA (KLAVUZ TELLİ)

PLASTIC CABLE PULLER (WITH GUIDE WIRE)

	049 019 400010	Takviyeli Plastik Susta 10 mt Plastic Cable Puller (with guide wire) 10 mt	Kutu Pack	-	-	-
	049 019 400015	Takviyeli Plastik Susta 15 mt Plastic Cable Puller (with guide wire) 15 mt	Kutu Pack	-	-	-
	049 019 400020	Takviyeli Plastik Susta 20 mt Plastic Cable Puller (with guide wire) 20 mt	Kutu Pack	-	-	-
	049 019 400025	Takviyeli Plastik Susta 25 mt Plastic Cable Puller (with guide wire) 25 mt	Kutu Pack	-	-	-

ÇELİK SUSTA

STEEL CABLE PULLER

	001 019 000010 00 00	1.Kalite 10 mt'lik Susta Premium Quality Cable Puller, 10 m	Kutu Pack	40	27.60 Kg	0.025
	001 019 000015 00 00	1.Kalite 15 mt'lik Susta Premium Quality Cable Puller, 15 m	Kutu Pack	30	31.08 Kg	0.025
	001 019 000020 00 00	1.Kalite 20 mt'lik Susta Premium Quality Cable Puller, 20 m	Kutu Pack	20	27.56 Kg	0.025
	001 019 000025 00 00	1.Kalite 25 mt'lik Susta Premium Quality Cable Puller, 25 m	Kutu Pack	15	25.8 Kg	0.025
	001 019 100010 00 00	1. Kalite 10 mt'lik Tak. Susta Premium Quality Cable Puller, 10 m, Reinforced	Kutu Pack	40	28.64 Kg	0.025
	001 019 100015 00 00	1. Kalite 15 mt'lik Tak. Susta Premium Quality Cable Puller, 15 m, Reinforced	Kutu Pack	30	31.98 Kg	0.025
	001 019 100020 00 00	1. Kalite 20 mt'lik Tak. Susta Premium Quality Cable Puller, 20 m, Reinforced	Kutu Pack	20	28.36 Kg	0.025
	001 019 100025 00 00	1. Kalite 25 mt'lik Tak. Susta Premium Quality Cable Puller, 25 m, Reinforced	Kutu Pack	15	26.55 Kg	0.025
	001 019 000001 00 00	Florasın Zinciri Fluorescent Chain	Kutu Pack	500 m	20.50 Kg	0.017

BETON DUVAR KASALARI

CONCRETE WALL CASINGS

	Kod Code	Açıklama Description	Ambalaj Packing	Adet Quantity	Ağırlık Weight	Hacim Volume
	000 700 200037 00 14  TSE CE	Buat Arka Kapak (Sarı) Junction Box Back Cover (Yellow)	Kutu Pack	500	6 Kg	0.018
	000 700 000037 00 14					
	000 700 200035 00 12  TSE CE	Buat Gövde 60'lık (Turuncu) Junction Box Body, 60 mm (Orange)	Kutu Pack	350	9.45 Kg	0.130
	000 700 000035 00 12					
	000 700 200256 00 14  TSE CE	Kalıba Tespit Elemanı (Sarı) Die Fixing Tool (Orange)	Kutu Pack	250	4.09 Kg	0.65
	000 700 000256 00 14					
	000 700 200039 00 12  TSE CE	Sığ Brüt Anahtar Kasası (Turuncu) Shallow Gross Switch Case (Orange)	Kutu Pack	500	12.53 Kg	0.130
	000 700 000039 00 12					
	000 700 200036 00 14  CE	Konik Gövde (Sarı) Conical Body (Yellow)	Kutu Pack	250	4.63 Kg.	0.034
	000 700 000036 00 14					
	000 700 200214 00 14  TSE CE	Aplik 20'lik (Sarı) Bracket Lamp, 20 mm (Yellow)	Kutu Pack	1000	4.34 Kg	0.029
	000 700 000214 00 14					
	000 700 200215 00 12  TSE CE	Aplik Eğik Bağlantı Dirseği (Turuncu) Bracket Lamp Scarf Joint Bracket (Orange)	Kutu Pack	1000	3.54 Kg	0.039
	000 700 000215 00 12					



PLASTİK KASA VE BUATLAR

PLASTIC CASINGS AND JUNCTION BOXES

	Kod Code	Açıklama Description
--	-------------	-------------------------

TURUNCU BUAT VE KASALAR

ORANGE JUNCTION BOXES AND CASINGS

	    001 046 131102 00 12 001 046 130102 00 12	Norm Kasa Norm Casing
	    001 046 131101 00 12 001 046 130101 00 12	Norm Buat Ø 14 Ø 18 Çıkışlı Norm Junction Box (with Ø14, Ø18 Outlets)
	    001 046 161102 00 12 001 046 160102 00 12	Geçmeli Plastik Kasa Click-Fit Plastic Casing
	    001 046 161101 00 12 001 046 160101 00 12	Geçmeli Derin Kasa Click-Fit Deep Casing
	  001 046 121100 00 12 001 046 120100 00 12	Geçmeli Alçıpan Kasa Click-Fit Drywall Casing
	    000 700 100160 00 12 000 700 000160 00 12	Geçmeli Derin Kasa Gövde Click-Fit Deep Casing Body
	    000 700 100073 00 12 000 700 000073 00 12	Geçmeli Derin Kasa Kapak Click-Fit Deep Casing Cover
	    001 046 121101 00 12 001 046 120101 00 12	Alçıpan Kasa 1'li Drywall Casing, Single
	    001 046 121102 00 12 001 046 120102 00 12	Alçıpan Kasa 2'li Drywall Casing, Double
	    001 046 121103 00 12 001 046 120103 00 12	Alçıpan Kasa 3'lü Drywall Casing, Triple
	    001 046 210002 00 12 001 046 170101 00 12	Tünel Kasa Tunnel Casing
	    001 046 210003 00 12 001 046 170102 00 12	Tünel Buat Tunnel Junction Box

SİYAH BUAT VE KASALAR

BLACK JUNCTION BOXES AND CASINGS

	126 046 130103	Norm Kasa Norm Casing
	126 046 130104	Norm Buat Ø 14 Ø 18 Çıkışlı Norm Junction Box (with Ø14, Ø18 Outlets)
	001 046 160102 00 00	Geçmeli Plastik Kasa Click-Fit Plastic Casing
	126 046 130106	Geçmeli Derin Kasa Click-Fit Deep Casing
	001 046 120100 00 11	Geçmeli Alçıpan Kasa Click-Fit Drywall Casing
	001 046 120101 00 11	Alçıpan Kasa 1'li Drywall Casing, Single
	001 046 120102 00 11	Alçıpan Kasa 2'li Drywall Casing, Double
	001 046 120103 00 11	Alçıpan Kasa 3'lü Drywall Casing, Triple
	001 046 170101 00 11	Tünel Kasa Tunnel Casing
	001 046 170102 00 11	Tünel Buat Tunnel Junction Box

PLASTİK DİRSEKLER

PLASTIC BRACKETS

	127 051 000014	Plastik Ø 14 Dirsek Plastic Bracket, Ø14
	127 051 000018	Plastik Ø 18 Dirsek Plastic Bracket, Ø18
	127 051 000026	Plastik Ø 26 Dirsek Plastic Bracket, Ø26

PLASTİK MUFLAR

PLASTIC PIPE SOCKETS

	001 051 020014 00 11	Plastik Ø 14 Muf Plastic Pipe Socket, Ø14
	001 051 020018 00 11	Plastik Ø 18 Muf Plastic Pipe Socket, Ø18
	001 051 020026 00 11	Plastik Ø 26 Muf Plastic Pipe Socket, Ø26
	001 051 020037 00 11	Plastik Ø 37 Muf Plastic Pipe Socket, Ø37
	001 046 000001 00 11	Plastik Takoz (Ø 14 Ø 18 Çıkışlı) Plastic Cleat (with Ø14, Ø18 Outlets)
	047 109 010013	Anahtar Altı (Desenli) Switch Casings (Patterned)

KROŞELER CABLE STRAPS

	Kod Code	Açıklama Description	Ambalaj Packing	Adet Quantity	Ağırlık Weight	Hacim Volume
--	-------------	-------------------------	--------------------	------------------	-------------------	-----------------

ANTİGRON BORU KROŞELERİ ANTIGRION PIPE STRAPS

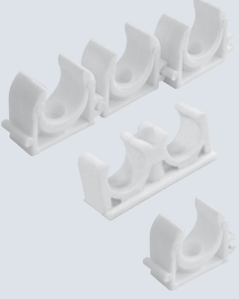
	001 048 010016 00 17	16'lik Antigrion Boru Kroşesi Antigrion Pipe Straps, Ø16	Kutu Pack	100	0,55 Kg	0,00210
	001 048 010018 00 17	18'lik Antigrion Boru Kroşesi Antigrion Pipe Straps, Ø18	Kutu Pack	100	0,42 Kg	0,00200
	001 048 010020 00 17	20'lik Antigrion Boru Kroşesi Antigrion Pipe Straps, Ø20	Kutu Pack	100	0,48 Kg	0,00243
	001 048 010022 00 17	22'lik Antigrion Boru Kroşesi Antigrion Pipe Straps, Ø22	Kutu Pack	-	-	-
	001 048 010025 00 17	25'lik Antigrion Boru Kroşesi Antigrion Pipe Straps, Ø25	Kutu Pack	100	0,59 Kg	0,00365
	001 048 010027 00 17	27'lik Antigrion Boru Kroşesi Antigrion Pipe Straps, Ø27	Kutu Pack	-	-	-
	001 048 010032 00 17	32'lik Antigrion Boru Kroşesi Antigrion Pipe Straps, Ø32	Kutu Pack	100	0,78 Kg	0,00427
	001 048 010040 00 17	40'lik Antigrion Boru Kroşesi Antigrion Pipe Straps, Ø40	Kutu Pack	50	0,46 Kg	0,00171

DÜBELLİ KROŞELER CABLE STRAPS WITH DOWEL

	001 048 090002 00 17	3/13 Tekli Kablo Kroşesi 3/13 Single Cable Strap	Kutu Pack	10000	5,49 Kg	0,03600
	001 048 090006 00 17	8/28 Tekli Kablo Kroşesi 8/28 Single Cable Strap	Kutu Pack	5000	4,98 Kg	0,03500
	001 048 090003 00 17	16'lik Dübelli Boru Kroşesi Tekli Pipe Crochet with Ø16 Dowel, Single	Kutu Pack	3000	4,80 Kg	0,19680
	001 048 090004 00 17	20'lik Dübelli Boru Kroşesi Tekli Pipe Crochet with Ø20 Dowel, Single	Kutu Pack	2000	4,55 Kg	0,03600
	001 048 090005 00 17	25'lik Dübelli Boru Kroşesi Tekli Pipe Crochet with Ø25 Dowel, Single	Kutu Pack	1500	4,49 Kg	0,03645

MUTLUSAN BETON ÇİVİLİ KROŞELER MUTLUSAN CABLE STRAPS WITH CONCRETE NAIL

	032 048 070000	No.0 Beton Çivili Kroş 0.75 Yassı Kord. Kroş No. 0 Cable Strap with Concrete Nail 0.75 Flat Cord Cable Strap	Kutu Pack	30000	26,7 Kg	0,060
	032 048 070001	No.1 Beton Çivili Kroş 0.75 Yassı Kord. Kroş No. 1 Cable Strap with Concrete Nail 0.75 Flat Cord Cable Strap	Kutu Pack	30000	27 Kg	0,060
	032 048 070002	No.2 Beton Çivili Kroş 0.75 Yassı Kord. Kroş No. 2 Cable Strap with Concrete Nail 0.75 Flat Cord Cable Strap	Kutu Pack	20000	20 Kg	0,028
	032 048 070003	No.3 Beton Çivili Kroş (2x1.5-3x1.5) No. 3 Cable Strap with Concrete Nail (2x1.5 - 3x1.5)	Kutu Pack	20000	28 Kg	0,060
	032 048 070004	No.4 Beton Çivili Kroş (2x4) No.4 Cable Strap with Concrete Nail (2x4)	Kutu Pack	20000	30 Kg	0,060
	032 048 070005	No.5 Beton Çivili Kroş (2x4-4x4) No. 5 Cable Strap with Concrete Nail (2x4-4x4)	Kutu Pack	10000	20 Kg	0,050
	032 048 070006	No.6 Beton Çivili Kroş (2x6) No. 6 Cable Strap with Concrete Nail (2x6)	Kutu Pack	10000	10 Kg	0,100
	032 048 070007	No.7 Beton Çivili Kroş (4x10) No. 7 Cable Strap with Concrete Nail (4x10)	Kutu Pack	8000	31,2 Kg	0,080
	032 048 070008	No.8 Beton Çivili Kroş (3x16+10) No. 8 Cable Strap with Concrete Nail (3x26+10)	Kutu Pack	5000	31 Kg	0,080

KROŞELER CABLE STRAPS

	Kod Code	Açıklama Description	Ambalaj Packing	Adet Quantity	Ağırlık Weight	Hacim Volume
--	-------------	-------------------------	--------------------	------------------	-------------------	-----------------

TANDIR KROŞELER METALLIC CABLE STRAPS

	035 048 110001	No.1 Tandır Kroşe (2x1.5-2x6) No. 1 Metallic Cable Straps	Kutu Pack	350	3,87 Kg	0,00270
	035 048 110002	No.2 Tandır Kroşe (4x6) No. 2 Metallic Cable Straps	Kutu Pack	250	2,16 Kg	0,00275
	035 048 110003	No.3 Tandır Kroşe (4x10) No. 3 Metallic Cable Straps	Kutu Pack	250	1,90 Kg	0,00200
	035 048 110004	No.4 Tandır Kroşe (4x16) No. 4 Metallic Cable Straps	Kutu Pack	150	2,11 Kg	0,00285
	035 048 110005	No.5 Tandır Kroşe (3x25+16) No. 5 Metallic Cable Straps	Kutu Pack	150	2,21 Kg	0,00281

RAY KROŞELER RAIL CABLE STRAPS

	035 048 100001	No.1 Ray Kroşe (2x1.5-4x2.5) No. 1 Rail Cable Straps	Kutu Pack	350	2,34 Kg	0,00560
	035 048 100002	No.2 Ray Kroşe (4x4-4x16) No. 2 Rail Cable Straps	Kutu Pack	250	2,13 Kg	0,00575
	001 025 010100 00 00	Galvaniz Ray Kroşe Galvanized Rail Cable Straps	Kutu Pack	50	12,50 Kg	0,01270

ANTİGRON KROŞELER ANTIGRAN CABLE STRAPS

	128 048 000001	No.1 (2x1.5-2x2.5-3x1.5-3x2.5)	Kutu Pack	3000	17,85 Kg	0,07500
	128 048 000015	No.1.5 (2x4-2x6-4x4-4x6)	Kutu Pack	2000	12,00 Kg	0,07600
	128 048 000002	No.2 (4x10)	Kutu Pack	1500	13,83 Kg	0,07500
	128 048 000003	No.3 (4x16-3x25+16)	Kutu Pack	1000	17,78 Kg	0,10800

GALVANİZ SAC KROŞELER GALVANIZED SHEET CABLE STRAPS

	001 048 060001 00 00	No.1 Tekli No. 1 Single Ø 10 mm	Kutu Pack	1500	6,60 Kg	0,00600
	001 048 060002 00 00	No.2 Tekli No. 2 Single Ø 14 mm	Kutu Pack	1000	6,00 Kg	0,00600
	001 048 060003 00 00	No.3 Tekli No. 3 Single Ø 16 mm	Kutu Pack	700	5,11 Kg	0,00630
	001 048 060004 00 00	No.4 Tekli No. 4 Single Ø 20 mm	Kutu Pack	500	4,25 Kg	0,00600
	001 048 060007 00 00	No.7 Tekli No. 7 Single Ø 25 mm	Kutu Pack	350	3,82 Kg	0,00595
	001 048 060008 00 00	No.8 Tekli No. 8 Single Ø 40 mm	Kutu Pack	250	3,28 Kg	0,00600
	001 048 060009 00 00	No.9 Tekli No. 9 Single Ø 45.5 mm	Kutu Pack	200	2,98 Kg	0,00600
	001 048 060010 00 00	No.10 Tekli No. 10 Single Ø 50.5 mm	Kutu Pack	150	2,31 Kg	0,00600
	001 048 070002 00 00	No.2 Çiftli No. 2 Double Ø 13 mm	Kutu Pack	600	4,85 Kg	0,00600
	001 048 070003 00 00	No.3 Çiftli No. 3 Double Ø 15.5 mm	Kutu Pack	500	4,17 Kg	0,00600
	001 048 070004 00 00	No.4 Çiftli No. 4 Double Ø 22 mm	Kutu Pack	400	3,70 Kg	0,00600
	001 048 070007 00 00	No.7 Çiftli No. 7 Double Ø 26 mm	Kutu Pack	400	4,92 Kg	0,00800
	001 048 070008 00 00	No.8 Çiftli No. 8 Double Ø 33 mm	Kutu Pack	300	4,09 Kg	0,00780
	001 048 070009 00 00	No.9 Çiftli No. 9 Double Ø 44 mm	Kutu Pack	200	3,43 Kg	0,00780
	001 048 070010 00 00	No.10 Çiftli No. 10 Double Ø 48 mm	Kutu Pack	150	2,84 Kg	0,00780
	001 048 070011 00 00	No.11 Çiftli No. 11 Double Ø 55.5 mm	Kutu Pack	100	2,08 Kg	0,00600

PLASTİK DÜBELLER

PLASTIC DOWELS

	Kod Code	Açıklama Description	Ambalaj Packing	Adet Quantity	Ağırlık Weight	Hacim Volume
	016 053 000014	Burgulu Alçıban Dübeli (Yeni) Twisted Drywall Dowel	Kutu Pack	10000	11 Kg	0,03000
	016 053 308100	8x100 mm Boşluk Dübeli 8x100 mm Spacer Dowel	Kutu Pack	10000	30 Kg	0,20000
	016 053 100002	Mega Dübel Mega Dowel	Kutu Pack	14000	21,840 Kg	0,08400
	001 053 000001 00 00	Alçıban Dübeli Drywall Dowel	Kutu Pack	15000	24 Kg	0,12810
	001 053 000002 00 00	Kanal Dübeli Trunking Dowel	Kutu Pack	14000	22,40 Kg	0,14000
	001 053 000005 00 00	Korniş Dübeli Curtain Rod Dowel	Kutu Pack	14000	25,20 Kg	0,14000
	016 053 000006	6 mm Beyaz Dübeli 6 mm Dowel, White	Kutu Pack	35000	28 Kg	0,33075
	016 053 000007	7 mm Beyaz Dübeli 7 mm Dowel, White	Kutu Pack	25000	15 Kg	0,05000
	016 053 000008	8 mm Beyaz Dübeli 8 mm Dowel, White	Kutu Pack	20000	20 Kg	0,18900
	016 053 000106	6 mm Renkli Dübeli (Yeşil) 6 mm Colored Dowel (Green)	Kutu Pack	35000	42 Kg	0,07000
	016 053 000107	7 mm Renkli Dübeli (Sarı) 7 mm Colored Dowel (Yellow)	Kutu Pack	25000	30 Kg	0,05000
	016 053 000108	8 mm Renkli Dübeli (Kırmızı) 8 mm Colored Dowel (Red)	Kutu Pack	10000	12 Kg	0,02000
	016 053 000110	10 mm Renkli Dübeli (Mavi) 10 mm Colored Dowel (Blue)	Kutu Pack	10000	12 Kg	0,05000

ASPIRATÖR FANS



100 mm 001 111 000100 00 00

Çalışma Akımı
Operation Voltage 220-240V / 50-60Hz

Emiş Hacmi
Airflow 100m³/h

Devir Hız
Round Speed 2250 rpm

Güç
Power 12W

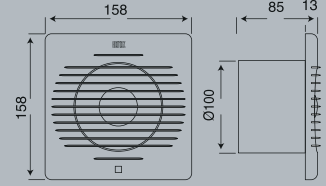

120 mm 001 111 000120 00 00

Çalışma Akımı
Operation Voltage 220-240V / 50-60Hz

Emiş Hacmi
Airflow 120m³/h

Devir Hız
Round Speed 1900 rpm

Güç
Power 15W

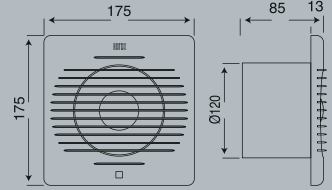

150 mm 001 111 000150 00 00

Çalışma Akımı
Operation Voltage 220-240V / 50-60Hz

Emiş Hacmi
Airflow 150m³/h

Devir Hız
Round Speed 1800 rpm

Güç
Power 20W

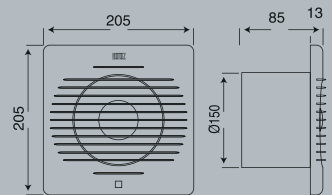

200 mm 001 111 000200 00 00

Çalışma Akımı
Operation Voltage 220-240V / 50-60Hz

Emiş Hacmi
Airflow 200m³/h

Devir Hız
Round Speed 2000 rpm

Güç
Power 40W

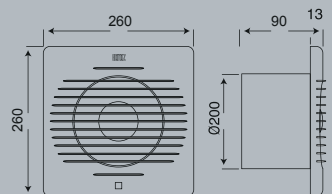



AYDINLATMA GRUBU
LIGHTING GROUP

Sıva Altı Yuvarlak Slim Led Paneller

Slim Led Panel - Flush Type



Wat	Kod Code	Işık Rengi Light Color	Lumen	CRI	Ölçü (mm) Size (mm)	Kesim Ölçüsü (mm) Cutting Size (mm)	IP
3 w	016 242 000970	3000K	300	80+	20x85	70	20
	016 242 000975	4000K					
	016 242 000980	6000K					
6 w	016 242 000990	3000K	600	80+	20x120	105	20
	016 242 000995	4000K					
	016 242 001000	6000K					
9 w	016 242 001010	3000K	900	80+	20x146	130	20
	016 242 001015	4000K					
	016 242 001020	6000K					
12 w	016 242 001030	3000K	1200	80+	20x170	155	20
	016 242 001035	4000K					
	016 242 001040	6000K					
15 w	016 242 001050	3000K	1500	80+	20x190	175	20
	016 242 001055	4000K					
	016 242 001060	6000K					
18 w	016 242 001070	3000K	1800	80+	20x220	205	20
	016 242 001075	4000K					
	016 242 001080	6000K					
24 w	016 242 001090	3000K	2400	80+	20x300	280	20
	016 242 001095	4000K					
	016 242 001100	6000K					

Sıva Üstü Yuvarlak Slim Led Paneller

Slim Led Panel - Surface Type

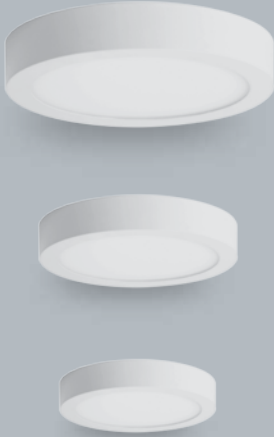

Wat	Kod Code	Işık Rengi Light Color	Lumen	CRI	Ölçü (mm) Size (mm)	IP
6 w	016 242 001420	3000K	600	80+	30x120	20
	016 242 001425	4000K				
	016 242 001430	6000K				
12 w	016 242 001440	3000K	1200	80+	30x174	20
	016 242 001445	4000K				
	016 242 001450	6000K				
18 w	016 242 001550	3000K	1800	80+	30x220	20
	016 242 001555	4000K				
	016 242 001560	6000K				
24 w	016 242 001170	3000K	2400	80+	30x300	20
	016 242 001175	4000K				
	016 242 001180	6000K				

Led Projektör

Led Projectors

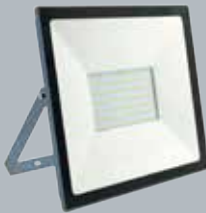

Wat	Kod Code	Işık Rengi Light Color	Lumen	CRI	IP
20 w	016 302 001600	6000	2000	80+	65
30 w	016 302 001630	6000	3000	80+	65
50 w	016 302 001660	6000	5000	80+	65
80 w	016 302 001690	6000	8000	80+	65
100 w	016 302 001720	6000	10000	80+	65
150 w	016 302 001750	6000	15000	80+	65
200 w	016 302 001780	6000	20000	80+	65

**T8**Sıvaüstü Çift Parabolik Armatürler (Elektronik Balastlı)
S/M Double Parabolic Lighting Luminaires (Electronic Ballast)

Ürün Kodu / Product Code

090 038 000218 TIL-218-SM S/Ü 2x18**090 038 000418** TIL-418-SM S/Ü 4x18**090 038 000236** TIL-236-SM S/Ü 2x36**Özellikler**

Gövde : 0.5mm DKP- Galvanizli sac
Boya : Beyaz elektrostatik toz boya
Güç : 230 V 50Hz
Reflektör : Yüksek kaliteli %99.99 safılıkta alüminyum parlak ve mat reflektor seçeneği.
Balast : Elektronik (Philips, Tridonic), Dim edilebilir ballast seçeneği
Opsiyon : Acil durum kiti

Description

Body : 0.5mm DKP - Galvanized steel
Paint : Electrostatic white powder paint
Power : 230 V 50 Hz
Reflector : High quality %99.99 pure aluminium specular or matt option.
Ballast : Electronic (Philips, Tridonic), Dimmable ballast option
Optional : Emergency kit

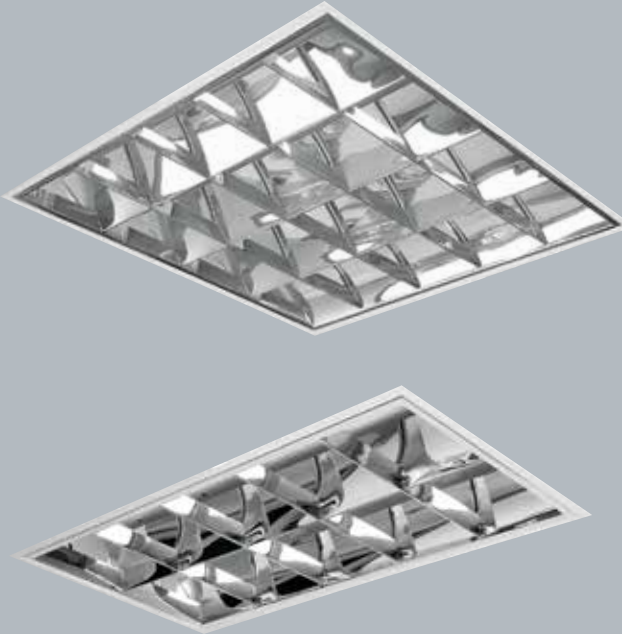
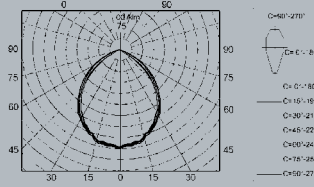
**T8**Sıvaaltı Çift Parabolik Armatürler (Elektronik Balastlı)
R/M Double Parabolic Lighting Luminaires (Electronic Ballast)

Ürün Kodu / Product Code

090 038 100218 TIL-218-RM S/A 2x18**090 038 100418** TIL-418-RM S/A 4x18**090 038 100236** TIL-236-RM S/A 2x36**Özellikler**

Gövde : 0.5mm DKP- Galvanizli sac
Boya : Beyaz elektrostatik toz boya
Güç : 230 V 50Hz
Reflektör : Yüksek kaliteli %99.99 safılıkta alüminyum parlak ve mat reflektor seçeneği.
Balast : Elektronik (Philips, Tridonic), Dim edilebilir ballast seçeneği
Opsiyon : Acil durum kiti

Description

Body : 0.5mm DKP - Galvanized steel
Paint : Electrostatic white powder paint
Power : 230 V 50 Hz
Reflector : High quality %99.99 pure aluminium specular or matt option.
Ballast : Electronic (Philips, Tridonic), Dimmable ballast option
Optional : Emergency kit

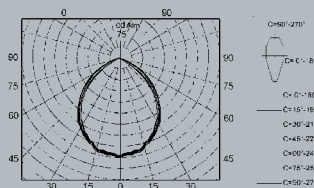

T8**Sıvaüstü Çift Parabolik Armatürler (Mekanik Balastlı)**
S/M Double Parabolic Lighting Luminaries (Mekanik Ballast)

Ürün Kodu / Product Code

090 039 171218 218-SM S/Ü 2x18**090 039 151418** 418-SM S/Ü 4x18**090 039 171236** 236-SM S/Ü 2x36**Özellikler**

Gövde : 0.5mm DKP- Galvanizli sac
Boya : Beyaz elektrostatik toz boya
Güç : 230 V 50Hz
Reflektör : Yüksek kaliteli %99.99 saflıkta alüminyum parlak ve mat reflektör seçeneği.
Balast : Elektronik (Philips, Tridonic), Dim edilebilir ballast seçeneği
Opsiyon : Acil durum kiti

Description

Body : 0.5mm DKP - Galvanized steel
Paint : Electrostatic white powder paint
Power : 230 V 50 Hz
Reflector : High quality %99.99 pure aluminium specular or matt option.
Ballast : Electronic (Philips, Tridonic), Dimmable ballast option
Optional : Emergency kit

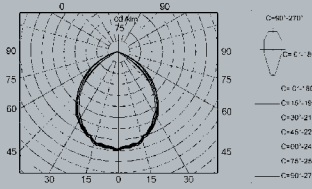
**T8****Sıvaaltı Çift Parabolik Armatürler (Mekanik Balastlı)**
R/M Double Parabolic Lighting Luminaries (Mekanik Ballast)

Ürün Kodu / Product Code

090 039 161218 218-RM S/A 2x18**090 039 141418** 418-RM S/A 4x18**090 039 161236** 236-RM S/A 2x36**Özellikler**

Gövde : 0.5mm DKP- Galvanizli sac
Boya : Beyaz elektrostatik toz boya
Güç : 230 V 50Hz
Reflektör : Yüksek kaliteli %99.99 saflıkta alüminyum parlak ve mat reflektör seçeneği.
Balast : Elektronik (Philips, Tridonic), Dim edilebilir ballast seçeneği
Opsiyon : Acil durum kiti

Description

Body : 0.5mm DKP - Galvanized steel
Paint : Electrostatic white powder paint
Power : 230 V 50 Hz
Reflector : High quality %99.99 pure aluminium specular or matt option.
Ballast : Electronic (Philips, Tridonic), Dimmable ballast option
Optional : Emergency kit

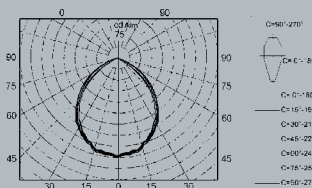

TMS**Bant Tipi T8 Mekanik Armatürler**
Batten Type T8 Mekanik Luminaries

Ürün Kodu / Product Code

078 038 900118 1x18W**078 038 900136** 1x36W**078 038 900218** 2x18W**078 038 900236** 2x36W**Özellikler**

Gövde : 0.5 mm DKP sac,
Boya : Beyaz elektrostatik
toz boya
Güç : 230 V 50 Hz

Description

Body : 0.5 mm DKP sheet
Paint : Electrostatic white
powder paint
Power : 230V 50 Hz

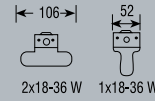

**U TİPİ**

Etanj Aydınlatma Armatürleri PC Cam
(Elektronik Tridonic Balastlı)

Waterproof Luminaires PC Glass
(Electronic Tridonic Ballast)

Ürün Kodu / Product Code

090 038 220118 1x18 PC Cam PC Gövde - 1x18 PC Glass PC Body

090 038 220218 2x18 PC Cam PC Gövde - 2x18 PC Glass PC Body

090 038 220136 1x36 PC Cam PC Gövde - 1x36 PC Glass PC Body

090 038 220236 2x36 PC Cam PC Gövde - 2x36 PC Glass PC Body

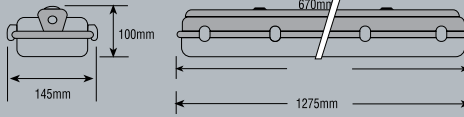
**U TİPİ**

Etanj Aydınlatma Armatürleri PC Cam
(Mekanik Balastlı)

Waterproof Luminaires PC Glass
(Mekanik Ballast)

Ürün Kodu / Product Code

090 038 210118 1x18 PC Cam PC Gövde - 1x18 PC Glass PC Body

090 038 210218 2x18 PC Cam PC Gövde - 2x18 PC Glass PC Body

090 038 210136 1x36 PC Cam PC Gövde - 1x36 PC Glass PC Body

090 038 210236 2x36 PC Cam PC Gövde - 2x36 PC Glass PC Body

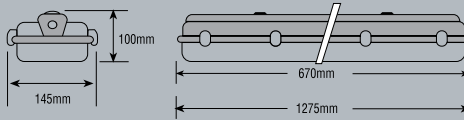
**U TİPİ**

Etanj Aydınlatma Armatürleri Akrilik Cam
(Mekanik Balastlı)

Waterproof Luminaires Acrylic Glass
(Mekanik Ballast)

Ürün Kodu / Product Code

066 038 910118 1x18 Akrilik Cam PC Gövde - 1x18 Acrylic Glass PC Body

066 038 910218 2x18 Akrilik Cam PC Gövde - 2x18 Acrylic Glass PC Body

066 038 910136 1x36 Akrilik Cam PC Gövde - 1x36 Acrylic Glass PC Body

066 038 910236 2x36 Akrilik Cam PC Gövde - 2x36 Acrylic Glass PC Body

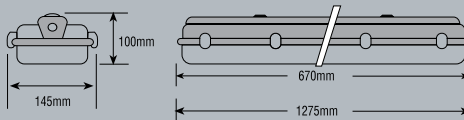

**MINİ**Tavan Glob Armatür
Ceiling Globe Lighting FixtureÜrün Kodu / Product Code
016 038 250031

CE

E27 MAX. 1x75W - 230 V ~ 50 Hz IP20

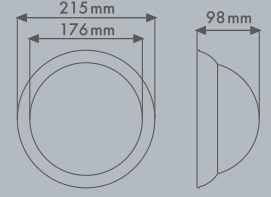

Ambalaj Şekli / Package Type	Kutu / Pack	Ağırlık / Weight	11,71 Kg
Adet / Quantity	48	m ³ / Volume	0,15101

**YASEMİN**Ufo Küre Tavan Armatürü
Ufo Globe Ceiling Lighting FixtureÜrün Kodu / Product Code
001 038 050101 00 00

CLASS II IP20

CE

E27 MAX. 1x60W - 230 V ~ 50 Hz

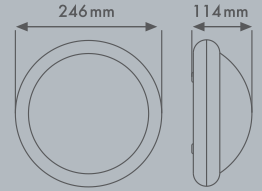

Ambalaj Şekli / Package Type	Kutu / Pack	Ağırlık / Weight	4,80 Kg
Adet / Quantity	12	m ³ / Volume	0,06120

**YASEMİN**Ufo Düz Tavan Armatürü
Ufo Flat Ceiling Lighting FixtureÜrün Kodu / Product Code
001 038 070101 00 00

CLASS II IP20

CE

E27 MAX. 1x60W - 230 V ~ 50 Hz

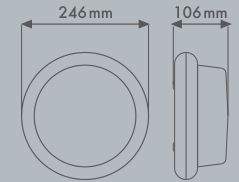

Ambalaj Şekli / Package Type	Kutu / Pack	Ağırlık / Weight	5,40 Kg
Adet / Quantity	12	m ³ / Volume	0,06120

**YASEMİN**Küre Tavan Armatürü
Globe Ceiling Lighting FixtureÜrün Kodu / Product Code
001 038 060101 00 00

CLASS I IP20

CE

E27 MAX. 1x60W - 230 V ~ 50 Hz

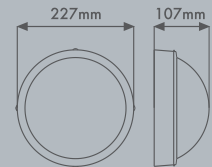

Ambalaj Şekli / Package Type	Kutu / Pack	Ağırlık / Weight	6,00 Kg
Adet / Quantity	12	m ³ / Volume	0,05630

**YASEMİN**Düz Tavan Armatürü
Flat Ceiling Lighting FixtureÜrün Kodu / Product Code
001 038 030101 00 00

CLASS I IP20

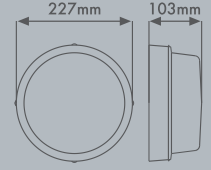

E27 MAX. 1x60W - 230 V ~ 50 Hz

Ambalaj Şekli / Package Type	Kutu / Pack	Ağırlık / Weight	6,50 Kg
Adet / Quantity	12	m ³ / Volume	0,05630

**YASEMİN**Ufo Tavan Armatürü
Ufo Ceiling Lighting FixtureÜrün Kodu / Product Code
001 038 040101 00 00

CLASS II IP20

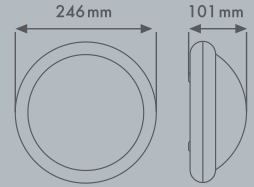

E27 MAX. 1x60W - 230 V ~ 50 Hz

Ambalaj Şekli / Package Type	Kutu / Pack	Ağırlık / Weight	5,20 Kg
Adet / Quantity	12	m ³ / Volume	0,06120

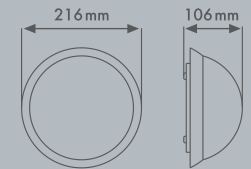
**ORKİDE**Tavan Armatürü
Ceiling Lighting FixtureÜrün Kodu / Product Code
001 038 120101 00 00

E27 MAX. 1x60W - 230 V ~ 50 Hz

Ambalaj Şekli / Package Type	Kutu / Pack	Ağırlık / Weight	12,48 Kg
Adet / Quantity	48	m ³ / Volume	0,15101

**YONCA**Tavan Armatürü
Lighting FixtureÜrün Kodu / Product Code
001 038 160101 00 00

CLASS I IP20

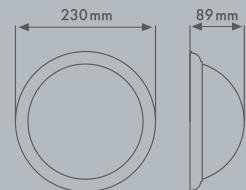

E27 MAX. 1x60W - 230 V ~ 50 Hz

Ambalaj Şekli / Package Type	Kutu / Pack	Ağırlık / Weight	6,93 Kg
Adet / Quantity	16	m ³ / Volume	0,06580

**OVAL**

Düz Armatür
Antigrön Lighting Fixture

Ürün Kodu / Product Code
016 038 250028

CE

E27 MAX. 1x60W - 230 V ~ 50 Hz IP20

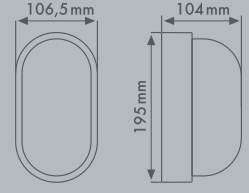

Ambalaj Şekli / Package Type	Kutu / Pack	Ağırlık / Weight	13,49 Kg
Adet / Quantity	48	m ³ / Volume	0,10560

**OVAL**

Kafesli Armatür
Oval Antigrön Lighting Fixture

Ürün Kodu / Product Code
016 038 250029

CE

E27 MAX. 1x60W - 230 V ~ 50 Hz IP20

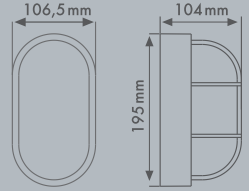

Ambalaj Şekli / Package Type	Kutu / Pack	Ağırlık / Weight	13,49 Kg
Adet / Quantity	48	m ³ / Volume	0,10560

**OVAL**
Nemliyer Waterproff

Düz Armatür
Antigrön Lighting Fixture

Ürün Kodu / Product Code
016 038 250039

E27 MAX. 1x60W - 230 V ~ 50 Hz IP 44

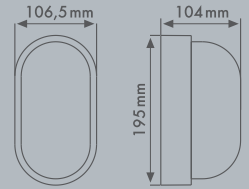

Ambalaj Şekli / Package Type	Kutu / Pack	Ağırlık / Weight	18,00 Kg
Adet / Quantity	48	m ³ / Volume	0,12831

**OVALLED**

Kafesli Led Armatür
Oval Antigrön Led Lighting Fixture

Ürün Kodu / Product Code
016 038 270001

IP 20

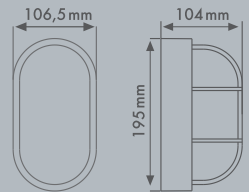

Ambalaj Şekli / Package Type	Kutu / Pack	Ağırlık / Weight	5,62 Kg
Adet / Quantity	20	m ³ / Volume	0,04400



BEGONYA

Nemliyer Waterproff

Tavan ve Duvar Armatürü (Dikey)
Ceiling & Wall Lighting Fixture (Vertical)

Ürün Kodu / Product Code
001 038 130101 00 00



CLASS II IP54



E27 MAX. 1x60W - 230 V ~ 50 Hz

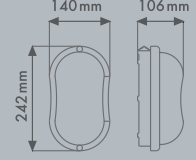

Ambalaj Şekli / Package Type	Kutu / Pack	Ağırlık / Weight	5,80 Kg
Adet / Quantity	12	m ³ / Volume	0,04620



BEGONYA

Nemliyer Waterproff

Tavan ve Duvar Armatürü (Yatay)
Ceiling & Wall Lighting Fixture (Horizontal)

Ürün Kodu / Product Code
001 038 140101 00 00



CLASS II IP54



E27 MAX. 1x60W - 230 V ~ 50 Hz

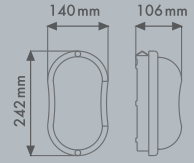

Ambalaj Şekli / Package Type	Kutu / Pack	Ağırlık / Weight	6,03 Kg
Adet / Quantity	12	m ³ / Volume	0,04620

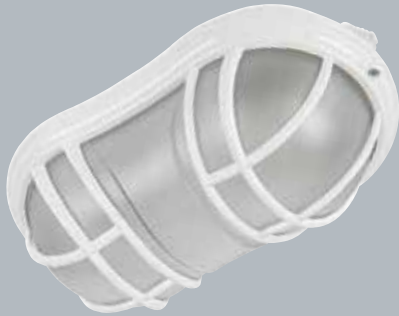

BEGONYA

Nemliyer Waterproff

Tavan ve Duvar Armatürü (Klasik)
Ceiling & Wall Lighting Fixture (Classic)

Ürün Kodu / Product Code
001 038 150101 00 00



CLASS II IP54



E27 MAX. 1x60W - 230 V ~ 50 Hz

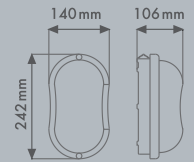

Ambalaj Şekli / Package Type	Kutu / Pack	Ağırlık / Weight	5,84 Kg
Adet / Quantity	12	m ³ / Volume	0,04620



FULYA

Aplik
Wall Lamp

Ürün Kodu / Product Code
001 038 020201 00 00



CLASS I IP20

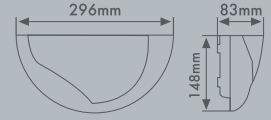

E27 MAX. 1x60W - 230 V ~ 50 Hz

Ambalaj Şekli / Package Type	Kutu / Pack	Ağırlık / Weight	7,00 Kg
Adet / Quantity	20	m ³ / Volume	0,05018



MANOLYA

Aplik
Wall Lamp

Ürün Kodu / Product Code
001 038 010201 00 00



CLASS I IP20

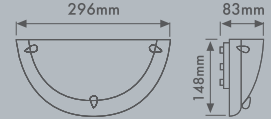

E27 MAX. 1x60W - 230 V ~ 50 Hz

Ambalaj Şekli / Package Type	Kutu / Pack	Ağırlık / Weight	6,00 Kg
Adet / Quantity	20	m ³ / Volume	0,05018



YASEMİN

Aplik
Wall Lamp

Ürün Kodu / Product Code
001 038 090101 00 00



CLASS I IP20

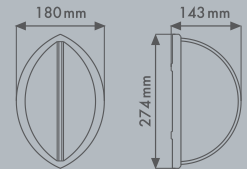

E27 MAX. 1x60W - 230 V ~ 50 Hz

Ambalaj Şekli / Package Type	Kutu / Pack	Ağırlık / Weight	12,00 Kg
Adet / Quantity	24	m ³ / Volume	0,08456

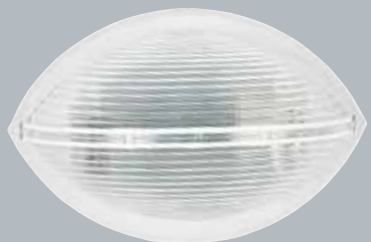

YASEMİN

Oval Tavan Armatürü
Oval Lighting Fixture

Ürün Kodu / Product Code
001 038 080101 00 00



CLASS I IP20

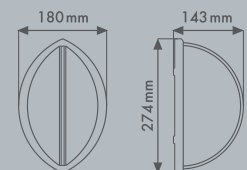

E27 MAX. 1x60W - 230 V ~ 50 Hz

Ambalaj Şekli / Package Type	Kutu / Pack	Ağırlık / Weight	12,00 Kg
Adet / Quantity	24	m ³ / Volume	0,08456

**FULYA**Tavan Armatürü
Ceiling Lighting FixtureÜrün Kodu / Product Code
001 038 020101 00 00

CLASS II IP20

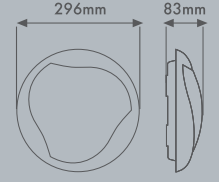

E27 MAX. 1x75W - 230 V ~ 50 Hz

Ambalaj Şekli / Package Type	Kutu / Pack	Ağırlık / Weight	3,40 Kg
Adet / Quantity	5	m ³ / Volume	0,03915

**AKASYA**Tavan Armatürü
Ceiling Lighting FixtureÜrün Kodu / Product Code
001 038 180101 00 00

CLASS II IP20

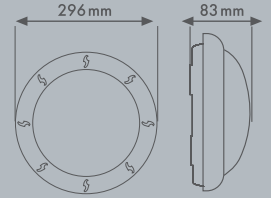

E27 MAX. 1x60W - 230 V ~ 50 Hz

Ambalaj Şekli / Package Type	Kutu / Pack	Ağırlık / Weight	3,40 Kg
Adet / Quantity	5	m ³ / Volume	0,03915

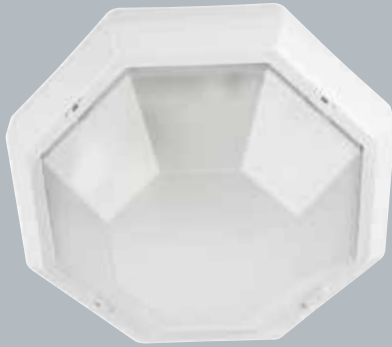
**KAMELYA**Tavan Armatürü
Ceiling Lighting FixtureÜrün Kodu / Product Code
001 038 170101 00 00

CLASS II IP54

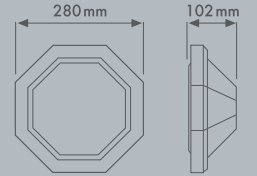

E27 MAX. 1x60W - 230 V ~ 50 Hz

Ambalaj Şekli / Package Type	Kutu / Pack	Ağırlık / Weight	2,50 Kg
Adet / Quantity	5	m ³ / Volume	0,02078

**MERVE**Tavan Armatürü
Ceiling Lighting FixtureÜrün Kodu / Product Code
001 038 110101 00 00

CLASS II IP20

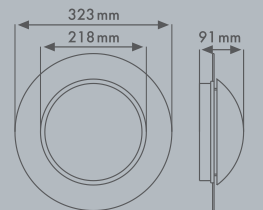

E27 MAX. 1x60W - 230 V ~ 50 Hz

Ambalaj Şekli / Package Type	Kutu / Pack	Ağırlık / Weight	3,40 Kg
Adet / Quantity	5	m ³ / Volume	0,05227



PİRAMİT

Aplik
Wall Lamp

Ürün Kodu / Product Code
001 038 190201 00 00



CLASS I IP20

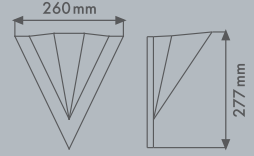

E27 MAX. 1x60W - 230 V ~ 50 Hz

Ambalaj Şekli / Package Type	Kutu / Pack	Ağırlık / Weight	9,00 Kg
Adet / Quantity	24	m ³ / Volume	0,08165



KRALIÇE

Duvar Aplik
Queen Wall Lamp

Ürün Kodu / Product Code
016 038 250013



E27 MAX. 1x60W - 230 V ~ 50 Hz IP20

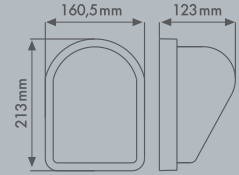

Ambalaj Şekli / Package Type	Kutu / Pack	Ağırlık / Weight	17,52 Kg
Adet / Quantity	48	m ³ / Volume	0,13915



MANOLYA

Tavan Armatürü
Ceiling Lighting Fixture

Ürün Kodu / Product Code
001 038 010101 00 00



CLASS II IP20

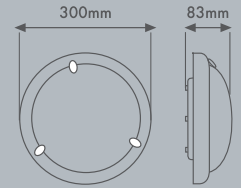

E27 MAX. 1x75W - 230 V ~ 50 Hz

Ambalaj Şekli / Package Type	Kutu / Pack	Ağırlık / Weight	2,60 Kg
Adet / Quantity	5	m ³ / Volume	0,03915

**SADE**

Hazır Askı Tij Takımı
Lamp Holder and Hanging Set

Ürün Kodu / Product Code
001 038 250018 00 00

CE

E27

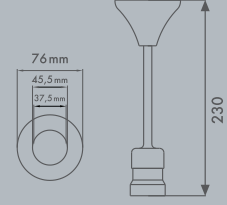

Ambalaj Şekli / Package Type	Kutu / Pack	Ağırlık / Weight	25,53 Kg
Adet / Quantity	300	m ³ / Volume	0,09000

**SADE**

Hazır Askı Tij Takımı (Muhafazalı)
Lamp Holder and Hanging Set (Protected)

Ürün Kodu / Product Code
001 038 250019 00 00

CE

E27

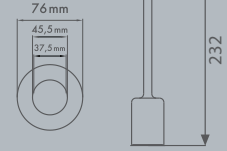

Ambalaj Şekli / Package Type	Kutu / Pack	Ağırlık / Weight	17,02 Kg
Adet / Quantity	200	m ³ / Volume	0,06000

**PAPATYA**

Askı Tij Takımı
Lamp Holder and Hanging Set

Ürün Kodu / Product Code
001 038 250016 00 00

CE

E27

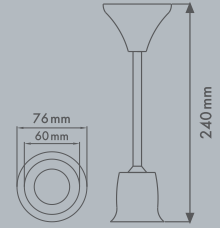

Ambalaj Şekli / Package Type	Kutu / Pack	Ağırlık / Weight	24,75 Kg
Adet / Quantity	275	m ³ / Volume	0,13750

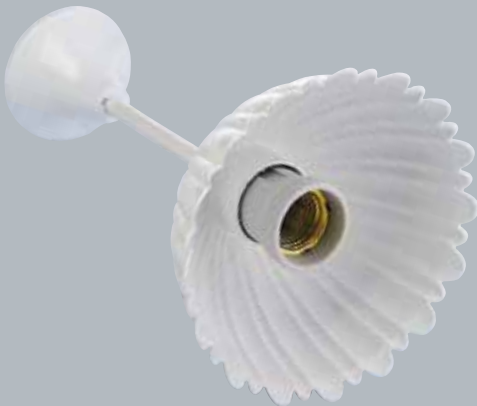
**PAPATYA**

Büyük Askı Tij Takımı
Lamp Holder and Hanging Set Big

Ürün Kodu / Product Code
001 038 250017 00 00

CE

E27

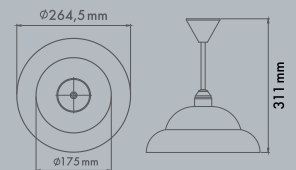

Ambalaj Şekli / Package Type	Kutu / Pack	Ağırlık / Weight	11,72 Kg
Adet / Quantity	80	m ³ / Volume	0,13600



AQUA

Nemliyer Waterproff

Kafesli Aplik Armatür Beyaz
Wall Fixture Antigron White

Ürün Kodu / Product Code
016 038 411100

CLASS II

IP 54

MAX. 26 W

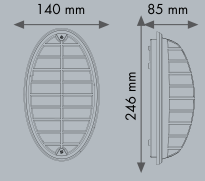

Ambalaj Şekli / Package Type	Kutu / Pack	Ağırlık / Weight	6,27 Kg
Adet / Quantity	5	m ³ / Volume	0,06720



AQUA

Nemliyer Waterproff

Kafesli Aplik Armatür Siyah
Wall Fixture Antigron Black

Ürün Kodu / Product Code
016 038 411111

CLASS II

IP 54

MAX. 26 W

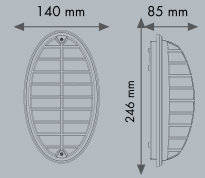

Ambalaj Şekli / Package Type	Kutu / Pack	Ağırlık / Weight	6,27 Kg
Adet / Quantity	5	m ³ / Volume	0,06720

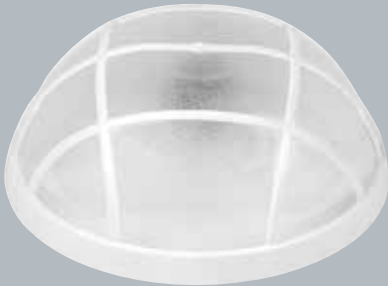

OPAK

Kafesli Armatür Beyaz
Fixture Antigron White

Ürün Kodu / Product Code
016 038 411300

CE CLASS II

IP 54

MAX. 26 W

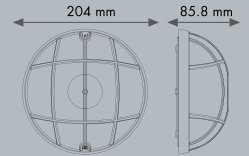

Ambalaj Şekli / Package Type	Kutu / Pack	Ağırlık / Weight	6,48 Kg
Adet / Quantity	24	m ³ / Volume	0,09072



OPAK

Kafesli Armatür Siyah
Fixture Antigron Black

Ürün Kodu / Product Code
016 038 411311

CE CLASS II

IP 54

MAX. 26 W

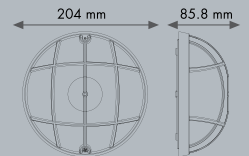

Ambalaj Şekli / Package Type	Kutu / Pack	Ağırlık / Weight	6,48 Kg
Adet / Quantity	24	m ³ / Volume	0,09072

**ELİPS**Opal Armatür Beyaz
Opal Lighting Fixture WhiteÜrün Kodu / Product Code
016 038 410600

CE CLASS II

IP 65

MAX. 26 W

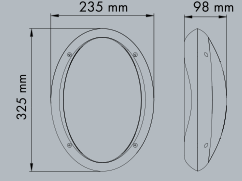

Ambalaj Şekli / Package Type	Kutu / Pack	Ağırlık / Weight	9,54 Kg
Adet / Quantity	10	m ³ / Volume	0,08200

**ELİPS**Opal Armatür Siyah
Opal Lighting Fixture BlackÜrün Kodu / Product Code
016 038 410611

CE CLASS II

IP 65

MAX. 26 W

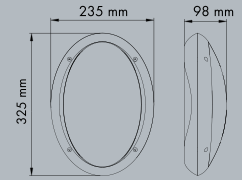

Ambalaj Şekli / Package Type	Kutu / Pack	Ağırlık / Weight	9,54 Kg
Adet / Quantity	10	m ³ / Volume	0,08200

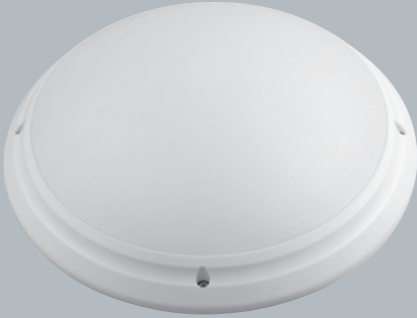
**OPAL**Armatür Beyaz
Lighting Fixture WhiteÜrün Kodu / Product Code
016 038 410500

CE CLASS II

IP 65

MAX. 26 W

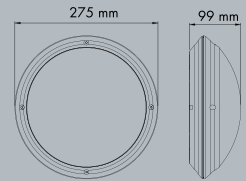

Ambalaj Şekli / Package Type	Kutu / Pack	Ağırlık / Weight	7,57 Kg
Adet / Quantity	10	m ³ / Volume	0,08100

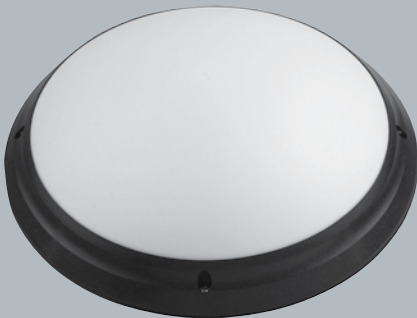
**OPAL**Armatür Siyah
Lighting Fixture BlackÜrün Kodu / Product Code
016 038 410511

CE CLASS II

IP 65

MAX. 26 W

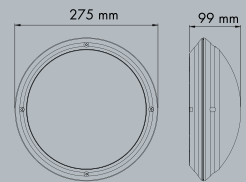

Ambalaj Şekli / Package Type	Kutu / Pack	Ağırlık / Weight	7,57 Kg
Adet / Quantity	10	m ³ / Volume	0,08100

**DOLUNAY**Opak Armatür Beyaz
Opak Lighting Fixture White

Ürün Kodu / Product Code
016 038 700100

CE CLASS II

IP 54

MAX. 26 W

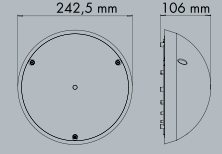

Ambalaj Şekli / Package Type	Kutu / Pack	Ağırlık / Weight	12,11 Kg
Adet / Quantity	16	m ³ / Volume	0,10080

**DOLUNAY**Opak Armatür Siyah
Opak Lighting Fixture Black

Ürün Kodu / Product Code
016 038 700111

CE CLASS II

IP 54

MAX. 26 W

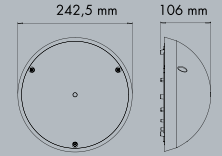

Ambalaj Şekli / Package Type	Kutu / Pack	Ağırlık / Weight	12,11 Kg
Adet / Quantity	16	m ³ / Volume	0,10080

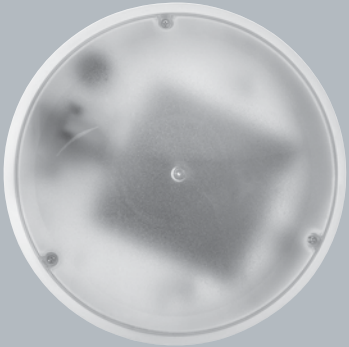
**DOLUNAY**Şeffaf Armatür Beyaz
Transparent Lighting Fixture White

Ürün Kodu / Product Code
016 038 700200

CE CLASS II

IP 54

MAX. 26 W

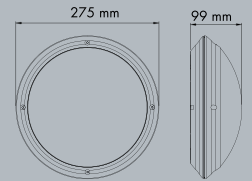

Ambalaj Şekli / Package Type	Kutu / Pack	Ağırlık / Weight	12,11 Kg
Adet / Quantity	16	m ³ / Volume	0,10080

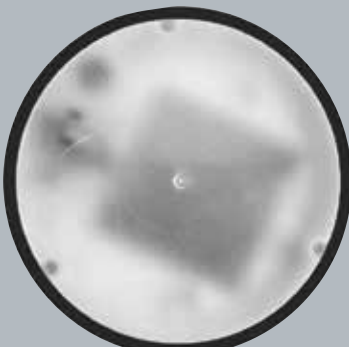
**DOLUNAY**Şeffaf Armatür Siyah
Transparent Lighting Fixture Black

Ürün Kodu / Product Code
016 038 700211

CE CLASS II

IP 54

MAX. 26 W

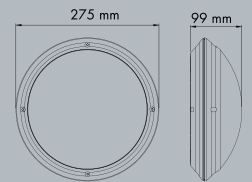

Ambalaj Şekli / Package Type	Kutu / Pack	Ağırlık / Weight	12,11 Kg
Adet / Quantity	16	m ³ / Volume	0,10080

**DOLUNAY**Opak Aplik Beyaz
Opak Wall Lamp WhiteÜrün Kodu / Product Code
016 038 700300

MAX. 26 W

IP 54

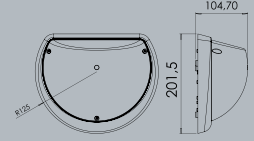

Ambalaj Şekli / Package Type	Kutu / Pack	Ağırlık / Weight	15,14 Kg
Adet / Quantity	20	m ³ / Volume	0,11000

**DOLUNAY**Opak Aplik Siyah
Opak Wall Lamp BlackÜrün Kodu / Product Code
016 038 700311

MAX. 26 W

IP 54

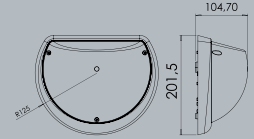

Ambalaj Şekli / Package Type	Kutu / Pack	Ağırlık / Weight	15,14 Kg
Adet / Quantity	20	m ³ / Volume	0,11000

**DOLUNAY**Şeffaf Armatür Beyaz
Transparent Lighting Fixture WhiteÜrün Kodu / Product Code
016 038 700400

MAX. 26 W

IP 54

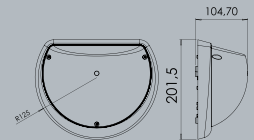

Ambalaj Şekli / Package Type	Kutu / Pack	Ağırlık / Weight	15,14 Kg
Adet / Quantity	20	m ³ / Volume	0,11000

**DOLUNAY**Şeffaf Armatür Siyah
Transparent Lighting Fixture BlackÜrün Kodu / Product Code
016 038 700411

MAX. 26 W

IP 54

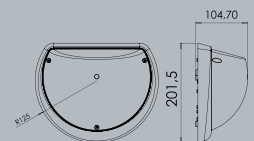

Ambalaj Şekli / Package Type	Kutu / Pack	Ağırlık / Weight	15,14 Kg
Adet / Quantity	20	m ³ / Volume	0,11000

**OPAK**Armatür Beyaz
Lighting Fixture WhiteÜrün Kodu / Product Code
016 038 410800

MAX. 26 W

CE IP 54

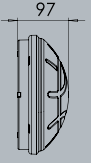
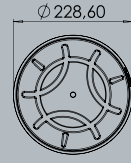

Ambalaj Şekli / Package Type	Kutu / Pack	Ağırlık / Weight	6,31 Kg
Adet / Quantity	16	m ³ / Volume	0,08464

**OPAK**Armatür Siyah
Lighting Fixture BlackÜrün Kodu / Product Code
016 038 410811

MAX. 26 W

CE IP 54

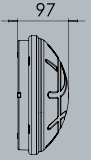

Ambalaj Şekli / Package Type	Kutu / Pack	Ağırlık / Weight	6,31 Kg
Adet / Quantity	16	m ³ / Volume	0,08464



**RADARLED**

Radarsensörlü Tavan Armatür
Radarsensor Globe Lighting Fixture

Ürün Kodu / Product Code
016 038 250081

Lumen 900 Renk 6500K
Lumen 900 Color 6500K

IP 20

Ambalaj Şekli / Package Type	Kutu / Pack	Ağırlık / Weight	1.2 kg.
Adet / m / Quantity / m	20	m ³ / Volume	0.146

**RADARLED**

Radarsensörlü Tavan Armatür
Radarsensor Globe Lighting Fixture

Ürün Kodu / Product Code
016 038 250082

Lumen 900 Renk 6500K
Lumen 900 Color 6500K

IP 20

Ambalaj Şekli / Package Type	Kutu / Pack	Ağırlık / Weight	1.2 kg.
Adet / m / Quantity / m	20	m ³ / Volume	0.146

**RADARLED**

Radarsensörlü Tavan Armatür
Radarsensor Globe Lighting Fixture

Ürün Kodu / Product Code
016 038 250083

Lumen 900 Renk 6500K
Lumen 900 Color 6500K

IP 20

Ambalaj Şekli / Package Type	Kutu / Pack	Ağırlık / Weight	1.2 kg.
Adet / m / Quantity / m	20	m ³ / Volume	0.146

**RADARLED**

Radarsensörlü Tavan Armatür
Radarsensor Globe Lighting Fixture

Ürün Kodu / Product Code
016 038 250084

Lumen 900 Renk 6500K
Lumen 900 Color 6500K

IP 20

Ambalaj Şekli / Package Type	Kutu / Pack	Ağırlık / Weight	1.2 kg.
Adet / m / Quantity / m	20	m ³ / Volume	0.146

**LED**Tavan Armatür
Lighting FixtureÜrün Kodu / Product Code
016 038 250071Lumen 900 Renk 6500K
Lumen 900 Color 6500K

IP 20

Ambalaj Şekli / Package Type	Kutu / Pack	Ağırlık / Weight	1.2 kg.
Adet / m / Quantity / m	20	m ³ / Volume	0.146

**LED**Tavan Armatür
Lighting FixtureÜrün Kodu / Product Code
016 038 250072Lumen 900 Renk 6500K
Lumen 900 Color 6500K

IP 20

Ambalaj Şekli / Package Type	Kutu / Pack	Ağırlık / Weight	1.2 kg.
Adet / m / Quantity / m	20	m ³ / Volume	0.146

**LED**Tavan Armatür
Lighting FixtureÜrün Kodu / Product Code
016 038 250073Lumen 900 Renk 6500K
Lumen 900 Color 6500K

IP 20

Ambalaj Şekli / Package Type	Kutu / Pack	Ağırlık / Weight	1.2 kg.
Adet / m / Quantity / m	20	m ³ / Volume	0.146

**LED**Tavan Armatür
Lighting FixtureÜrün Kodu / Product Code
016 038 250074Lumen 900 Renk 6500K
Lumen 900 Color 6500K

IP 20

Ambalaj Şekli / Package Type	Kutu / Pack	Ağırlık / Weight	1.2 kg.
Adet / m / Quantity / m	20	m ³ / Volume	0.146

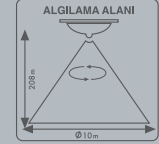
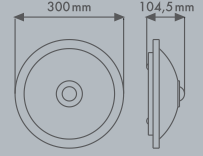
360°**Hareket Sensörlü Glob Armatür**
Sensor Globe Lighting Fixture**Ürün Kodu / Product Code****001 038 250022 00 00****E27 MAX. 2x25W - 230 V ~ 50 Hz IP20**

Ambalaj Şekli / Package Type	Kutu / Pack	Ağırlık / Weight	12,55 Kg
Adet / Quantity	10	m ³ / Volume	0,12900

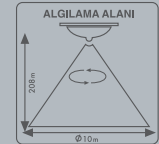
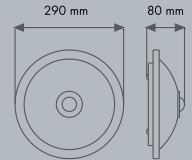
80 LED**Ledli Sensörlü Tavan Armatürü**
Led Sensor Ceiling Fixture**Ürün Kodu / Product Code****016 038 250044****80 Adet / 8 lm / 20 mA 120° LED**
230 V ~ 50 Hz**IP 20**

Ambalaj Şekli / Package Type	Kutu / Pack	Ağırlık / Weight	10,00 Kg
Adet / Quantity	10	m ³ / Volume	0,07600

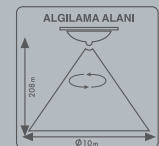
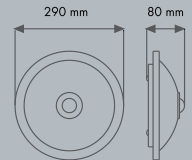
80 KROMLED**Ledli Sensörlü Tavan Armatürü**
Led Chrome Sensor Ceiling Fixture**Ürün Kodu / Product Code****016 038 600080****80 Adet / 8 lm / 20 mA 120° LED**
230 V ~ 50 Hz**IP 20**

Ambalaj Şekli / Package Type	Kutu / Pack	Ağırlık / Weight	10,75 Kg
Adet / Quantity	10	m ³ / Volume	0,07600



LEDSENSÖR

Led Sensörlü Glob Armatür
Sensor Led Lighting Fixture

Ürün Kodu / Product Code
016 038 250061

E27 MAX. 2x25W - 230 V ~ 50 Hz IP20

Ambalaj Şekli / Package Type Kutu / Pack

Adet / m / Quantity / m 10

Ağırlık / Weight 10,00 kg

m³ / Volume 0,07560

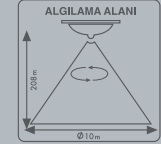
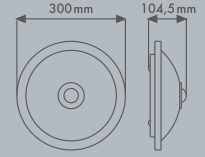

LEDSENSÖR

Led Sensörlü Glob Armatür - Kitli
Sensor Led Lighting Fixture - Kit

Ürün Kodu / Product Code
016 038 250060

E27 MAX. 2x25W - 230 V ~ 50 Hz IP20

Ambalaj Şekli / Package Type Kutu / Pack

Adet / m / Quantity / m 10

Ağırlık / Weight 10,00 kg

m³ / Volume 0,07560

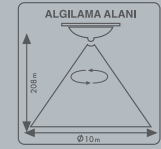
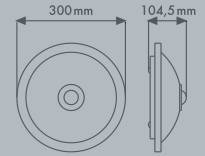

LEDSENSÖR

Duvar Aplik
Queen Wall Lamp

Ürün Kodu / Product Code
078 039 500110

E27 MAX. 2x25W - 230 V ~ 50 Hz IP20

Ambalaj Şekli / Package Type Kutu / Pack Ağırlık / Weight 7,80 Kg

Adet / Quantity 10 m³ / Volume 0,05800

SENSÖR

E27 Duyulu Duvar Aplik
E27 Lamp Holder Wall Lamp

Ürün Kodu / Product Code
078 039 500100

E27 MAX. 2x25W - 230 V ~ 50 Hz IP20

Ambalaj Şekli / Package Type Kutu / Pack Ağırlık / Weight 7,80 Kg

Adet / Quantity 10 m³ / Volume 0,05800



**DEKORATİF**Cam Armatür Beyaz
Glass Fixture WhiteÜrün Kodu / Product Code
079 039 140003

MAX. 2x60 W

CE IP 20

Ambalaj Şekli / Package Type	Kutu / Pack	Ağırlık / Weight	15,70 Kg
Adet / Quantity	12	m ³ / Volume	0,13440

**DEKORATİF**Cam Armatür Krom Beyaz
Glass Fixture Chrome WhiteÜrün Kodu / Product Code
079 039 140002

MAX. 2x60 W

CE IP 20

Ambalaj Şekli / Package Type	Kutu / Pack	Ağırlık / Weight	15,70 Kg
Adet / Quantity	12	m ³ / Volume	0,13440

**GÜNEŞ**Cam Armatür
Glass FixtureÜrün Kodu / Product Code
079 039 140005

MAX. 2x60 W

CE

Ambalaj Şekli / Package Type	Kutu / Pack	Ağırlık / Weight	16,00 Kg
Adet / Quantity	12	m ³ / Volume	0,13440

**GÜNEŞ**Yarım Ay Cam Aplik
Half Moon Glass Wall LampÜrün Kodu / Product Code
079 039 140001

MAX. 2x60 W

Ambalaj Şekli / Package Type	Kutu / Pack	Ağırlık / Weight	26,40 Kg
Adet / Quantity	20	m ³ / Volume	0,11250

**CAM ARMATÜR**Cam Armatür Çift Duylu
Glass Fixture Lamp HolderÜrün Kodu / Product Code
078 039 130002

MAX. 2x60 W

CE IP 20

Ambalaj Şekli / Package Type	Kutu / Pack	Ağırlık / Weight	15,70 Kg
Adet / Quantity	12	m ³ / Volume	0,13495

**CAM ARMATÜR**Cam Armatür Krom Çift Duylu
Glass Fixture Chrome Lamp HolderÜrün Kodu / Product Code
078 039 130001

MAX. 2x60 W

CE IP 20

Ambalaj Şekli / Package Type	Kutu / Pack	Ağırlık / Weight	15,70 Kg
Adet / Quantity	12	m ³ / Volume	0,13495

**MARTI**Cam Armatür
Glass FixtureÜrün Kodu / Product Code
078 039 130130

MAX. 2x60 W

CE

Ambalaj Şekli / Package Type	Kutu / Pack	Ağırlık / Weight	16,00 Kg
Adet / Quantity	12	m ³ / Volume	0,13495



MARTI

Yarım Ay Cam Aplik
Half Moon Glass Wall Lamp

Ürün Kodu / Product Code
078 039 130200

MAX. 2x60 W

Ambalaj Şekli / Package Type	Kutu / Pack	Ağırlık / Weight	26,40 Kg
Adet / Quantity	20	m ³ / Volume	0,11250



ACİLLED

Sıvaüstü Acil Aydınlatma Armatürü
Surface Mounted Emergency Lighting

Ürün Kodu / Product Code

112 039 011717 17 LED

112 039 013434 34 LED

112 039 015151 51 LED

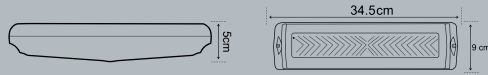

ACİLLED

Sıvaaltı Acil Aydınlatma Armatürü
Recessed Mounted Emergency Lighting

Ürün Kodu / Product Code

112 039 121717 17 LED

112 039 123434 34 LED

112 039 125151 51 LED

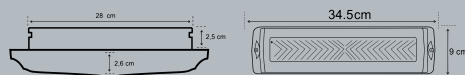



SEYYAR AYDINLATMA

EXTENSIBLE PARK AND GARDEN LIGHTING



Kod Code	Açıklama Description	Lumen	Güç Power	Işık Sıcaklığı Light Temperature
010 093 100900	9W 5'Li Led Lamba Seti Dış Mekan (Park ve Bahçeler için Kurulumu Kolay Seyyar Aydınlatma Seti) Outdoor led lamp set 9 W - 5 Pcs (Easy to mount, can be used park and garden)	750 lm	9W	3000K
010 093 100005	Power Kablo 5 MT 220V (Erkek Soketli) Power cable 5 mt 220V (male socket)			
010 093 100001	T Bağlantı Adaptörü T Branch	750 lm	9W	3000K
010 093 100901	9W Led + Ara Kablo 25cm + Erkek Konnektör Takımı 9W Led + intermediate cable 25 cm + male connector set			
010 093 100000	1 Metre Ara Kablo İki Tarafı Konnektör Takılı 1 meter cable (double side connector)			
010 093 100002	Sonlandırma Tapası End cover			



LED AMPUL LED BULD

Kod Code	Açıklama Description
010 093 100101	Led Ampul 7W-220V (IP 67) Yeşil Led bulb 7W-220V (IP 67) Green
010 093 100102	Led Ampul 7W-220V (IP 67) Kırmızı Led bulb 7W-220V (IP 67) Red
010 093 100103	Led Ampul 7W-220V (IP 67) Mavi Led bulb 7W-220V (IP 67) Blue
010 093 100104	Led Ampul 7W-220V (IP 67) Amber Led bulb 7W-220V (IP 67) Amber
010 093 100105	Led Ampul 7W-220V (IP 67) Soğuk Beyaz Led bulb 7W-220V (IP 67) 6500 K
010 093 100106	Led Ampul 7W-220V (IP 67) Sıcak Beyaz Led bulb 7W-220V (IP 67) 3000 K
010 093 100107	Led Ampul 7W-220V (IP 67) Mor Led bulb 7W-220V (IP 67) Purple



DEĞİŞTİRİLEBİLİR
KAPAK
COVER CAN BE
CHANGED
SİLİKON CONTA
SILICONE GASKET
7W LED AMPUL
7W LED BULB
E27 DUY
LAMP HOLDER



SİYAH

DUY TAKIMI LAMP HOLDER

Kod Code	Açıklama Description
010 093 100121	Siyah Duy Takımı (Ampul Hariç) Black Lamp Holder (Without Bulb)





FLORA

Bahçe Armatürü
Garden Light

Ürün Kodu / Product Code

016 038 010116 Siyah / Black

016 038 020116 Beyaz / White



Ambalaj Şekli / Package Type	Kutu / Pack	Ağırlık / Weight	6,42 Kg
Adet / Quantity	12	m ³ / Volume	0,1299



FLORA

Aplik
Wall Lamp

Ürün Kodu / Product Code

016 038 010117 Siyah / Black

016 038 020117 Beyaz / White



Ambalaj Şekli / Package Type	Kutu / Pack	Ağırlık / Weight	6,51 Kg
Adet / Quantity	12	m ³ / Volume	0,1299



FLORA

Tavan Tipi
Ceiling Type

Ürün Kodu / Product Code

016 038 412011 Siyah / Black

016 038 412000 Beyaz / White

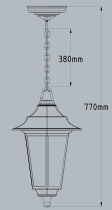

Ambalaj Şekli / Package Type	Kutu / Pack	Ağırlık / Weight	6,16 Kg
Adet / Quantity	12	m ³ / Volume	0,1178



FLORA

Yarım Aplik
Bracket

Ürün Kodu / Product Code

016 038 412111 Siyah / Black

016 038 412100 Beyaz / White

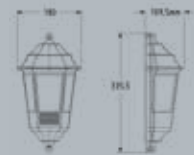

Ambalaj Şekli / Package Type	Kutu / Pack	Ağırlık / Weight	7,42 Kg
Adet / Quantity	20	m ³ / Volume	0,1253



GARDEN

Yer Aydınlatma
Floor Lighting

Ürün Kodu / Product Code
016 038 010118 Siyah / Black
016 038 010119 Beyaz / White

Ambalaj Şekli / Package Type	Kutu / Pack	Ağırlık / Weight	4,630 Kg
Adet / Quantity	12	m ³ / Volume	0,097



GARDEN

Uzun Yer Aydınlatma
Long Floor Lighting

Ürün Kodu / Product Code
016 038 010120 Siyah / Black
016 038 010121 Beyaz / White

Ambalaj Şekli / Package Type	Kutu / Pack	Ağırlık / Weight	4,260 Kg
Adet / Quantity	8	m ³ / Volume	0,1029

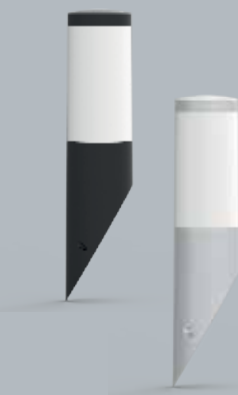

GARDEN

Duvar Aydınlatma
Wall Lighting

Ürün Kodu / Product Code
016 038 010122 Siyah / Black
016 038 010123 Beyaz / White

Ambalaj Şekli / Package Type	Kutu / Pack	Ağırlık / Weight	6,900 Kg
Adet / Quantity	20	m ³ / Volume	0,0542



GARDEN

Aplik
Bracket

Ürün Kodu / Product Code
016 038 010124 Siyah / Black
016 038 010125 Beyaz / White

Ambalaj Şekli / Package Type	Kutu / Pack	Ağırlık / Weight	8,300 Kg
Adet / Quantity	16	m ³ / Volume	0,0723

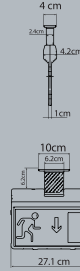

LED ACİL DURUM

Cift Yüzlü Yön Tavan Serisi
Acil Durum Armatürü
Double Sided For Ceiling
Emergency Lighting

Ürün Kodu / Product Code
112 038 1000 - XX

- Dekoratif ABS gövde
- Acilde veya sürekli çalışma
- 1 veya 3 saat yanma süresi
- NI-CD Uzun ömürlü batarya
- Pleksiglas üzeri gravür veya UV uygulama
- Aşırı şarj ve deşarja karşı koruma
- Şarj olma süresi 24 saat

- Decorative ABS Body
- Runs continuously or in Emergency
- Lighting duration of 1 or 3 hours
- NI-CD long life battery
- Engraving on Plexiglass
- Different colour options in bulk orders
- Ultra-bright LEDs

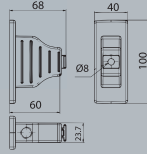

LED ACİL DURUM

Cift Yüzlü Yön Duvar Serisi
Acil Durum Armatürü
Double Sided For Wall Ceiling
Emergency Lighting

Ürün Kodu / Product Code
112 038 2000 - XX

- Dekoratif ABS gövde
- Acilde veya sürekli çalışma
- 1 veya 3 saat yanma süresi
- NI-CD Uzun ömürlü batarya
- Pleksiglas üzeri gravür veya UV uygulama
- Aşırı şarj ve deşarja karşı koruma
- Şarj olma süresi 24 saat

- Decorative ABS Body
- Runs continuously or in Emergency
- Lighting duration of 1 or 3 hours
- NI-CD long life battery
- Engraving on Plexiglass
- Different colour options in bulk orders
- Ultra-bright LEDs



LED ACİL DURUM

Cift Yüzlü (Alüminyum) İşaret Serisi
Acil Durum Armatürü
Double Sided Aluminium
Sign - Emergency Lighting

Ürün Kodu / Product Code
112 038 3000 - XX

- Dekoratif alüminyum eloksallı gövde
- Acilde veya sürekli çalışma
- 1 veya 3 saat yanma süresi
- NI-CD Uzun ömürlü batarya
- Pleksiglas üzeri gravür uygulama
- Ultra parlak ledler
- Aşırı şarj ve deşarja karşı koruma
- Şarj olma süresi 24 saat

- Decorative Aluminium Anodised Body
- Option for Lighting continuously or in emergency
- Lighting duration of 1 or 3 hours
- NI-CD long life battery
- Engraving on Plexiglass
- Ultra-Bright LEDs
- Protection against over-charge and discharge
- 24 Hour Charging time

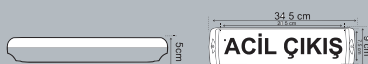

LED ACİL DURUM

Bilgi Serisi
Acil Durum Armatürü
Bilgi Series
Info - Emergency Lighting

Ürün Kodu / Product Code
112 038 4000 - XX

- Acilde 1 veya 3 saat yanma süresi
- NI-CD Uzun ömürlü batarya
- Acilde veya sürekli çalışma
- Akrilik üzeri folyo uygulama
- Şarj olma süresi 24 saat

- Lighting duration of 1 or 3 hours
- NI-CD long life battery
- Option for Lighting continuously or in emergency
- Foil printing on acrylic board
- 24 Hour Charging time



LED ACİL DURUM

**Cift Yüzlü Sıvaüstü Serisi
Acil Durum Armatürü**
Double Sided S/M
Emergency Lighting

Ürün Kodu / Product Code
112 038 5000 - XX

- Çağdaş ve şık tasarım
- Acilde veya sürekli çalışma
- 1 veya 3 saat yanma süresi
- NI-CD Uzun ömürlü batarya
- Pleksiglas üzeri gravür uygulama
- Sıva üstü kullanım ile tavana montaj
- Ultra parlak ledler
- Aşırı şarj ve deşarja karşı koruma
- Şarj olma süresi 24 saat
- Dekoratif ABS gövde

- Modern and Elegant Design
- Option for Lighting continuously or in Emergency
- Lighting duration of 1 or 3 hours
- NI-CD long life battery
- Engraving on Plexiglass
- Surface mounted on ceiling
- Ultra-bright LEDs
- 24 Hour Charging time
- Protection against over-charge and discharge
- Decorative ABS Body



LED ACİL DURUM















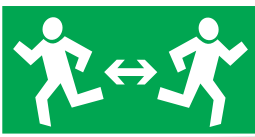

**Cift Yüzlü Sıvaaltı Serisi
Acil Durum Armatürü**
Double Sided F/M
Emergency Lighting

Ürün Kodu / Product Code
112 038 6000 - XX

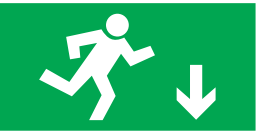
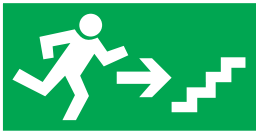
- Çağdaş ve şık tasarım
- Acilde veya sürekli çalışma
- 1 veya 3 saat yanma süresi
- NI-CD Uzun ömürlü batarya
- Pleksiglas üzeri gravür uygulama
- Sıva altı kullanım ile tavana montaj
- Ultra parlak ledler
- Aşırı şarj ve deşarja karşı koruma
- Şarj olma süresi 24 saat
- Dekoratif ABS gövde

- Modern and Elegant Design
- Option for Lighting continuously or in Emergency
- Lighting duration of 1 or 3 hours
- NI-CD long life battery
- Engraving on Plexiglass
- Recessed Mounted on ceiling
- Ultra-bright LEDs
- 24 Hour Charging time
- Protection against over-charge and discharge
- Decorative ABS Body

SEMBOL KOD TABLOSU SYMBOL CODES

01		02		03		04	
05		06		07		08	
09		10		11		12	
13		14		15		16	
17		18					

EXIT - ACİL AYDINLATMA ARMATÜRLERİ (LEDLİ) IP20

FOSFORLU SERİ ACİL AYDINLATMA ARMATÜRÜ



102 038 0008XX - CEXA

- *GÖVDE : ABS
- *CAM : Polistren (PS) isteğe bağlı Akrilik(PMMA) veya Policarbon(PC)
- *BASKI : Akrilik Işık geçirgen Translucent Folyo
- *ÇALIŞMA : Acil de ve Şebeke de sürekli çalışma
- *PİL : 3.6V 80mAH NiMH (NikelMethalhidrid)
- *ŞARJ SÜRESİ : 14-20 Saat
- *DEŞARJ SÜRESİ : 60 Dk veya isteğe bağlı 180 Dk
- *KORUMA SINIFI : IP20
- *LED : 4.8mm 6000K Beyaz Mantar Led veya 2835 6400K EDİSON OPTO SMD Led
- TÜKETİM : 2 Watt

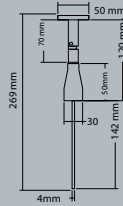
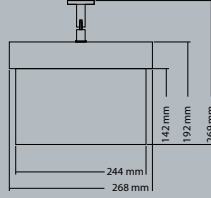

102 038 0009XX - CEXA-FS

- * ABS gövde
- * Kristal (PS) cam (İsteğe bağlı Akrilik (PMMA) ve Polikarbon (PC) cam
- * 100 micron akrilik fosfor blok
- * 0.40 Akrilik Phosphor Folyo
- * 2-4 saat Fosfor ışık yansımaları (İsteğe bağlı 4-6 saat/6-8 saat/8-12 saat)
- * Işık depolama uygun ışık yoğunluğunun sa 6-8 saat
- * Sudan ve Nemden etkilenmez
- * IP65

01	02	03	04	05	06	07	08
09	10	11	12	13	14		
15	16	17	18	19	20		
21	22	23	24	25	26		
27	28	29	30	31	32		
33	34	35	36				
37	38	39	40	41	42	43	
44	45	46	47	48	49	50	51
52	53	54	55	56	57	58	59
60	61	62	63	64	65		

Mutlusan Plastik Elektrik Tic. ve San. A.Ş.

İkitelli Org.San. Bölgesi Mahallesi Enkoop Cad.
No:7 Başakşehir- İstanbul
Tel : +90 (212) 485 05 44 (PBX)
Faks : +90 (212) 485 10 12

Karaköy Şube

Okçumusa Cad. Güneşhan İş Hanı No : 24/10
Karaköy-İstanbul
Tel : +90 (212) 237 06 02 (PBX)
Fax: +90 (212) 237 77 47

Perpa Şube

Perpa Tic. Merkezi. A Blok Kat: 2
No: 9-009 Okmeydanı - İstanbul
Tel : +90 (212) 320 05 78 (PBX)
Fax: +90 (212) 320 05 81



mutlusan.com.tr